

MEMO



Operating Manual



**THE FIRE
OF AUSTRIA.**

1. PREFACE	3
Explanations to symbols	3
Spare part overview exploded diagram	4
Spare part overview article numbers	6
Dimensions	7
Amount of fuel	7
Technical data.....	7
Packaging	7
Electrical connection	7
2. IMPORTANT INFORMATION	8
General warning and safety information	8
First heating.....	8
Safety distances	8
Prior to set up.....	9
The correct chimney connection	9
3. BRIEF INFORMATION ON FUEL - PELLETS	10
What are pellets?	10
Wood pellet specification according to ENplus – A1	10
Pellet container refilling during operation	10
Pellet storage	10
4. TECHNOLOGY AND SAFETY FUNCTIONS	11
Operating comfort.....	11
Top efficiency - lowest emissions.....	11
Overheating.....	11
Low-temperature shutdown	11
Electrical excess current protection.....	11
Automatic cleaning cycle.....	11
Component monitoring	11
Auger motor monitoring	11
Power failure (during heating).....	11
Power failure (during the initial stage).....	11
5. INSTALLING THE STOVE	12
General information	12
Connection to the chimney	12
Connecting to a steel chimney	12
Combustion air.....	12
Feeding in external combustion air.....	12
6. ASSEMBLY/DISMANTLING STOVE AND OPTIONS	13
Disassembly of the front side casing.....	13
7. INTERNAL CONTROLS	14
Basics	14
Operation	14
EASY MODE - simple heating operation	14
EASY OFF - inactive state	14
Start - scavenge - tip - ignition	14
Stopping during ignit or startphase.....	15
EASY 40 – operation	15
Cleaning and tipping during operation	15
EASY 40 – switch off.....	15
Extended heating operation - HEAT MODE - comfort funktions	16
Menu structure and main menu level	17
Main menu time - time adjustment	18
Main menu setup - additional functions	20
Main menu info - additional information	22

8. COMFORT OPTIONS **24**

RIKA room sensor/RIKA radio room sensor.....24

RIKA phone option – GSM24

RIKA interface for various options.....24

External room thermostat24

External connection cable bridge.....24

9. MODES **25**

Pellet operation Heat/Easy/Automatic/Room25

Pellet container refilling during operation25

Emergency operation - heating up without electrical Ignition.....25

10. MENU OVERVIEW V1.40 **26**

11. WARNINGS AND ERROR MESSAGES **28**

12. MAINTENANCE **29**

Open the combustion chamber door29

Cleaning of the burn pot - daily29

Cleaning the flame temperature sensor29

Cleaning the door glass29

Cleaning painted surfaces.....29

13. CLEANING **30**

Cleaning the convection air openings.....30

Combustion air - intake30

Cleaning the flue gas channels and flue gas collecting duct.....30

Clean flue gas fan housing.....31

Cleaning the pellet container.....31

Bearings.....31

Cleaning the flue pipes.....31

Checking door seal.....31

14. PROBLEMS - POSSIBLE SOLUTIONS **32**

Problem 132

Problem 232

Problem 332

15. INSTRUCTIONS FOR COMMISSIONING PROTOCOL **33**

16. WARRANTY **35**

1. PREFACE

Explanations to symbols

 <p>...Important note</p>	 <p>...Hex #8</p>	 <p>...Allen key #3</p>
 <p>...Useful tip</p>	 <p>...Hex #10</p>	 <p>...Manually</p>

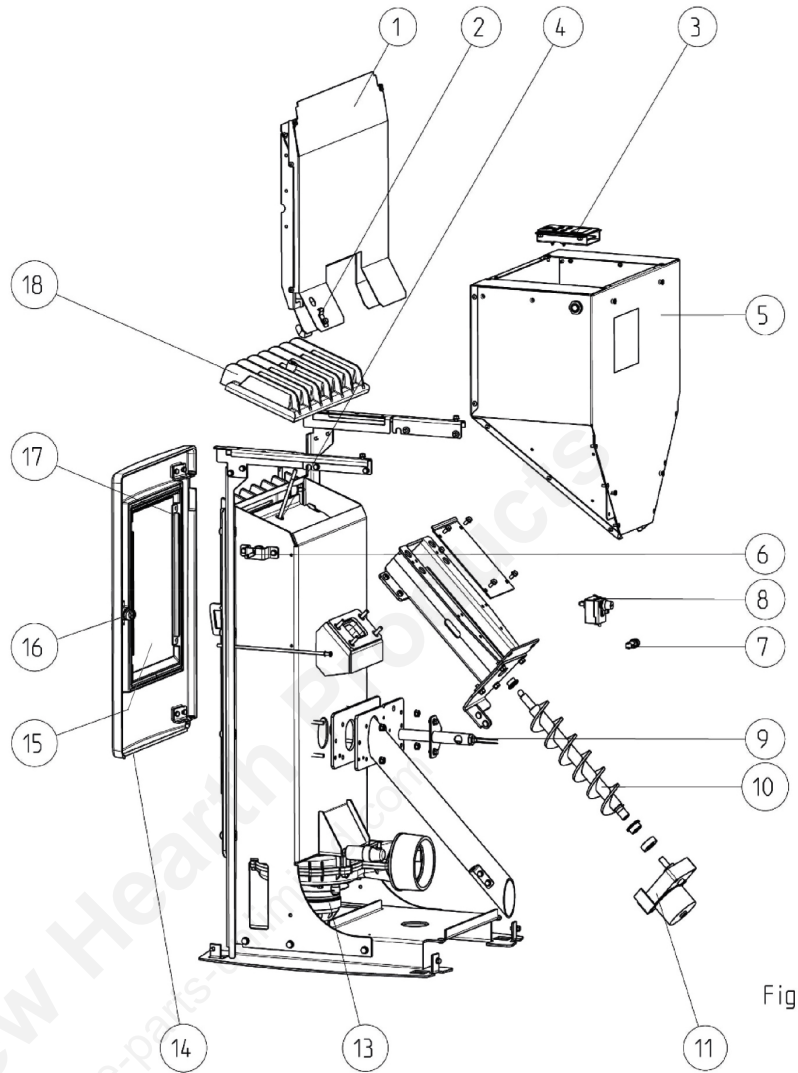

Fig.3

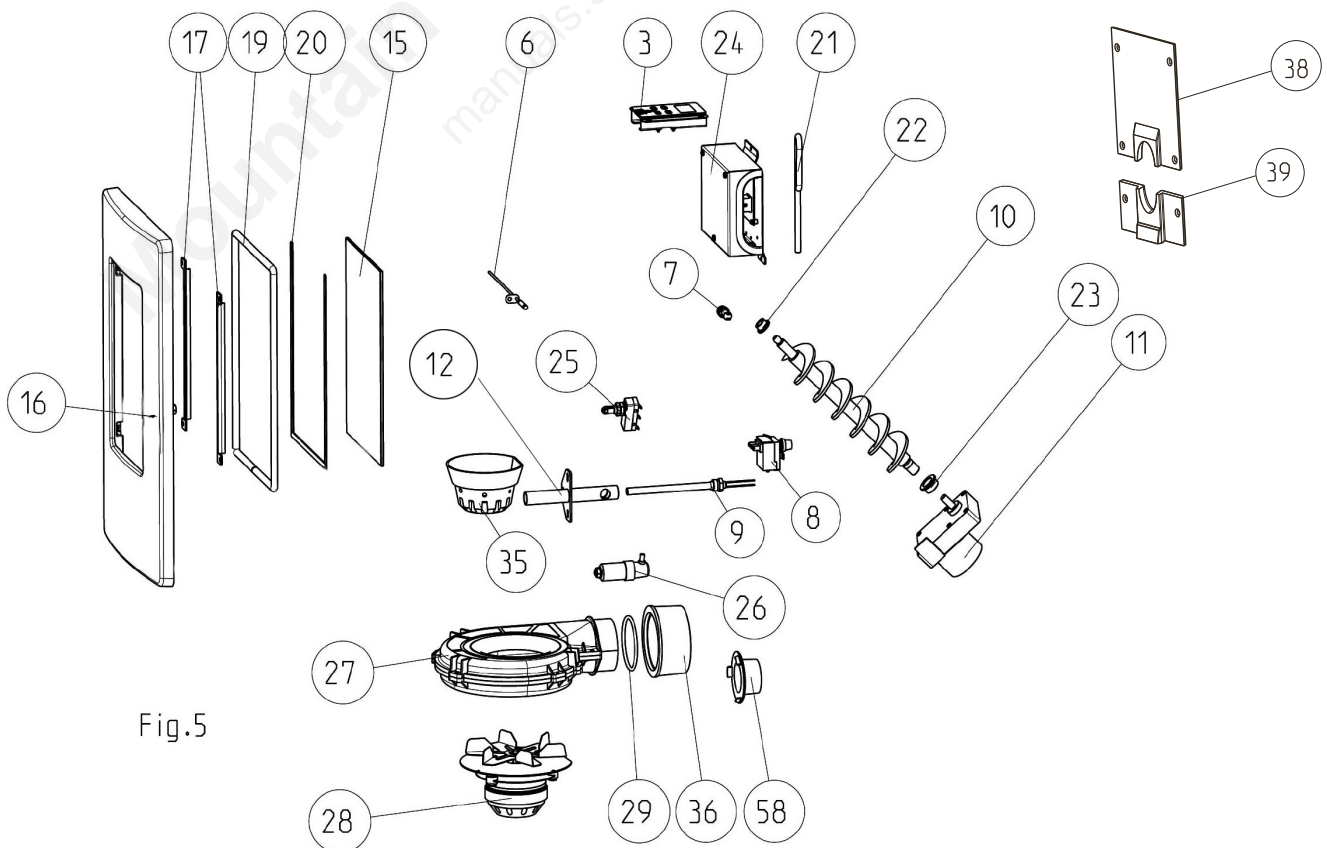
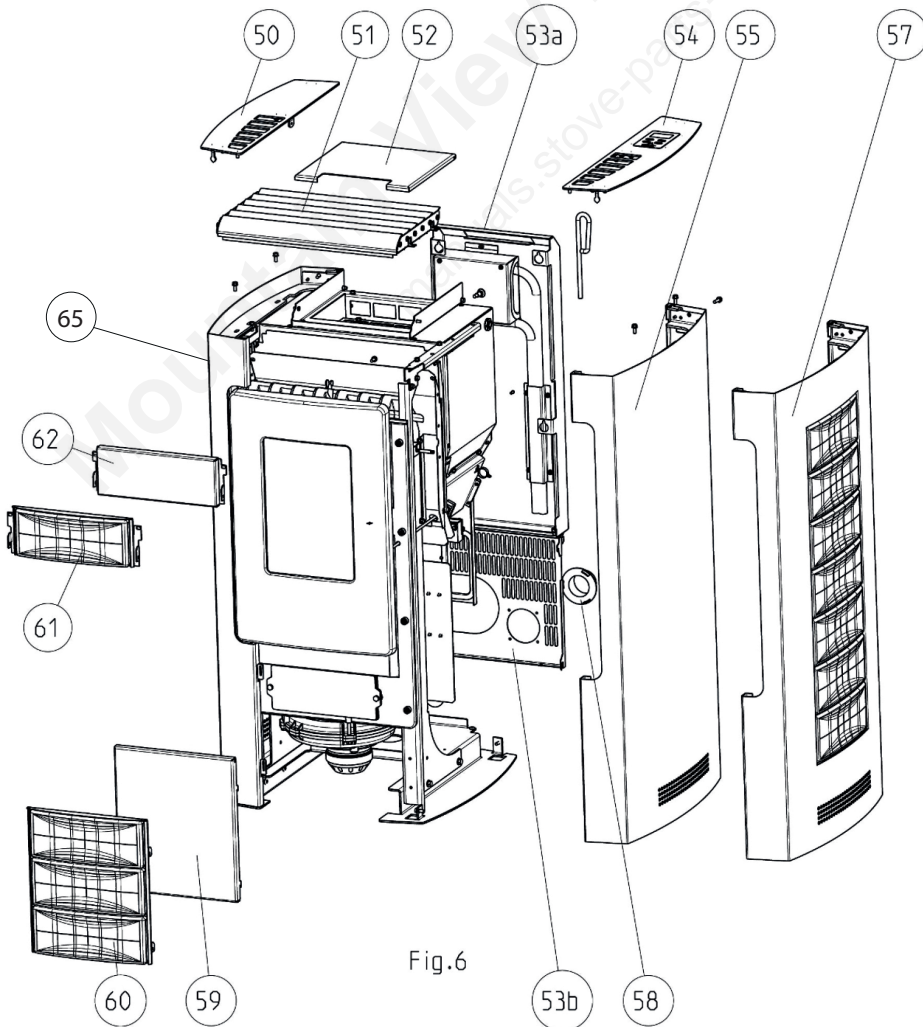
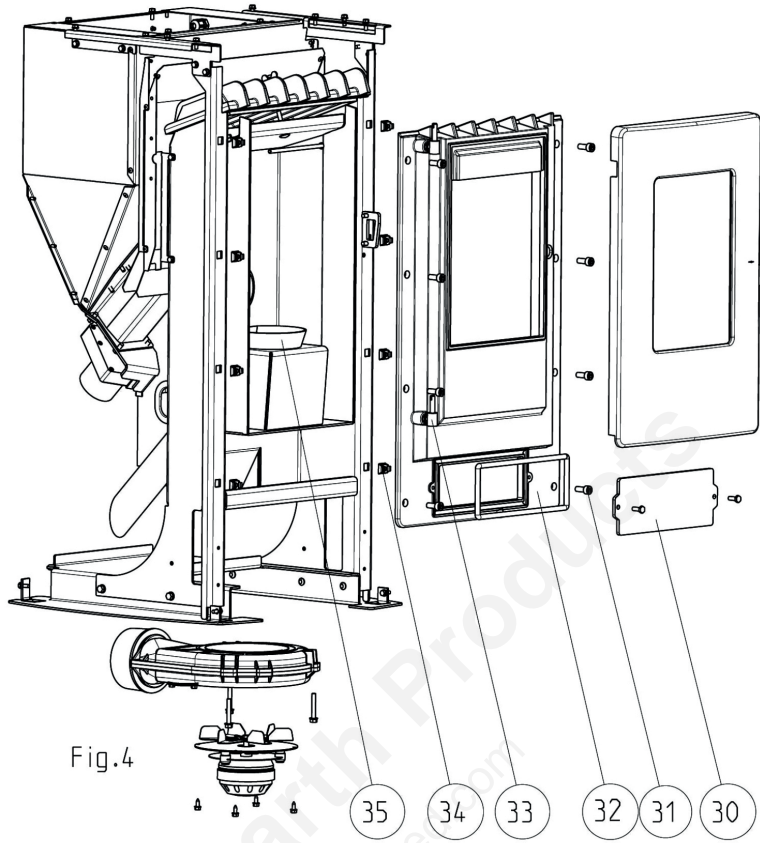

Fig.5



Spare part overview article numbers

Nr.	Art.Nr.	Description	Nr.	Art.Nr.	Description	Nr.	Art.Nr.	Description
1	B15245	Heat protection assy					L01512	Cover right black
2	Z31459	Sensor clamp	24 *3	B15302	Control assy incl. Key display	55	LB00441	Casing right assy, cast grey
3	B16521	Key display			Main board (from serial number 177781 till 203251)		B15261	Casing right assy, cast grey (till serial number 203251)
4 *1	L00426	Baffle plate	24	B15609	Main board (from serial number 203252 till 1328865)		LB00576	Casing right, cast grey assy
4 *2	L02585	Baffle plate		B16270	Motherboard C2 (for Key display)	57	LB00447	Right side panel (without ceramic)
5	B15782	Container assy		B15856	Door contact switch	58	Z18278	Air intake
6 *3	B15671	Flame temperatur sensor	25	N111825	Capacitor	59	Z32424	Casing front/bottom, silver
6	no plug	Flame sensor (177781-203069)	26	N111597	Induced draft fan housing		B18072	Stone bottom white assy
6	no plug	Flame sensor (203070-227999)	27	B16155	Induced draft fan motor	62	Z35705	Casing front/top silver
6 *4	N111515	Flame sensor	28 *3	N111512	Induced draft fan motor		B15790	Casing front/top silver (till serial number 1317840)
6 *5	B16114	Temperature sensor	28	N111581	O-ring D76/4.5		B15257	Casing front/top silver (till serial number 203251)
*1	B15248	Sensor tube	29	N108315	Cleaning opening metallic grey		B18071	Stone top white assy
*2	B16053	Sensor tube	30	Z32422	Hexagon socket screw	65	LB00442	Casing left assy, cast grey
*1	L00433	Pressure bracket	31	N100055	Combustion chamber front assy		B15260	Casing left assy, cast grey (till serial number 203251)
*2	L01441	Pressure bracket	32	B15243	Hinge		LB00577	Casing left assy, cast grey
	N108131	Pressure spring	33	B15868	Hexagonal nut M8		LB00448	Left side panel (without ceramic)
7	N107887	Fuse holder		N106283	Cage nut electro-galvanised, cage NR M8		N111604	Fuse 2,5A
8	N111586	Safety temperature limiter	34	N106591	Fire trough		L00797	Motor plate
9 *3	Z32147	Ignition cartridge	35	Z32345	Pipe adapter		B16030	Add. board motor
10	B12301	Auger	36	Z18502	Wiring harness		Z33136	Cable for Key display
11 *3	B15732	Set auger motor	37 *3	B15283	Wiring harness (from serial number 177781 till 203069)		Z32910	Switching rod
	B15773	Auger motor (from serial number 177782 till 1328865)	37	B15545	Wiring harness (from serial number 203070 till 1328865)		N108912	Self-tapping screw
	N112030	Screw motor, stepless	37	B15800	Wiring harness		E15472	Sealing kit
12 *6	B17394	Ceramic ignition	37	Z34546	Cast rear panel, top, metallic grey		*1	Till serial number 1328865
*3	Z32421	HP bracket	38	Z33841	Cast rear panel, top black		*2	from serial number 1328866
13	B15587	Fan assy	39	Z33908	Cast rear panel bottom metallic grey		*3	Till serial number 177781
14	Z36225	Comb.chamber door black up to series 1301733	39	Z33842	Cast rear panel bottom black		*4	from serial number 228000 till 1328865
	Z36226	Comb.chamber door metallic up to series 1301733	50	Z33907	Cover left assy		*5	from serial number 1328866
	Z33879	Comb. chamber door black		L01018	Cover left assy (till serial number 203251)		*6	Since serial number 177782 possible, requires 2,5A fuse (N111604) till serial number 1344314
	Z32344	Combustion chamber door metallic grey	51	L01514	Cover left black		*7	Up to serial number 1301733 the firebox door complet can be supplied as a spare part. In addition (N112017) is required as key.
*7	B16133	Comb.chamber door compleet, black	51	B16020	Convection fin assy		*8	Up to serial number 1331613 the motor plate (L00797) must be supplied as a spare part when replacing the plastic bearing Di16 (Z35182).
*7	B15249	Comb. chamber door assy metallic		B15253	Convection fin assy (till serial number 203251)			
15	Z32340	Door glass		B17250	Convection fins black comp.			
16	Z34857	Locking bolt	52	L01021	Container cover metallic rey			
	L02220	Lock tongue		L00434	Container lid (till serial number 203251)			
	B15313	Door opener assy until nb 1301733		Z36124	Container lid black			
	N112017	Key	53a *1	L01016	Rear wall top			
17	L00437	Glass holder	53b *1	L01025	Rear wall bottom			
	N107488	Hexagonal screw	53 *2	LB00622	Rear wall metallic			
18 *1	B15244	Combustion chamber lid assy	53 *2	LB00621	Rear panel assy black			
*2	B16321	Combustion chamber cover metallic grey	54	L01017	Cover right assy			
*2	B16052	Combustion chamber cover black		B15251	Cover right assy (till serial number 203251)			
19	N100485	Round sealing strip black D12						
20	N103693	Flat seal black 8x2						
21	N112018	Key						
22	Z35183	Friction bearing Di10						
23 *8	Z35182	Friction bearing Di16						

Note: Please consider the powdercoated parts can differ slightly in colour and colour effects though they are elaborated in high quality.

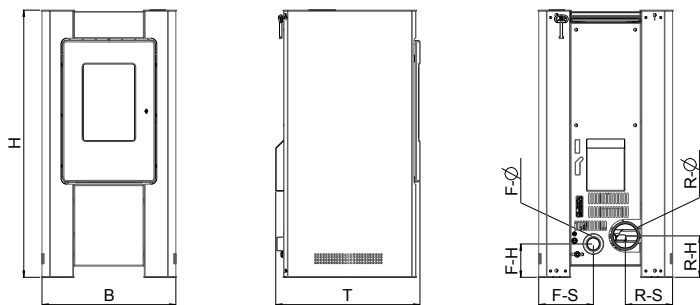

Dimensions

Height	[mm]	978
Width	[mm]	490
Corpus depth	[mm]	528

Weight

Weight without shell	[kg]	ca. 95
----------------------	------	--------

Flue pipe connection

R - Ø Flue pipe outlet	[mm]	100
RO - H Original angle pipe connection height	[cm]	-
RO - T1 Original angle pipe total depth	[cm]	-
RO - T2 Original angle pipe distance to rear wall	[cm]	-
RO - T3 Depth from rear wall to middle of flue pipe	[cm]	-
RO - S Original angle pipe side distance	[cm]	-
R - H Rear connection height	[cm]	15
R - S Rear connection side distance	[cm]	17

Fresh air connection

F - Ø Diameter	[mm]	50
F - H Connection height	[cm]	12
F - S Side distance	[cm]	20

Convection air connection

K - Ø Diameter	[mm]	-
K - H Connection height	[cm]	-
K - S Side distance	[cm]	-

Amount of fuel

	Nominal load	Part load
Amount of fuel	~2,1kg*	~0,6kg*
Burn time at full pellet hopper	ca. 11h	ca. 28h

*Practical values may vary depending on pellet quality.

Note

Pellet consumption depends on the size of the pellets. The larger the pellet, the slower the feed and vice versa.

Technical data

Heating power range	[kW]	2,5 - 9
Room heating capacity (depending on house insulation)	[m³]	50 - 240
Fuel consumption	[kg/h]	till 2,1
Pellet container capacity	[l/kg]	31/~20
Electric supply	[V]/[Hz]	230/50
Average electrical input	[W]	~ 20
Fuse	[A]	2,5 AT
Efficiency	[%]	91,8
CO2	[%]	11,1
CO-emission on 13% O2	[mg/m _N ³]	36,5
Dust emission	[mg/m _N ³]	23,5
Exhaust	[g/s]	6,5
Exhaust temperature	[°C]	140
Chimney draft requirement	[Pa]	3

The owner of small firing systems or the person authorised for the small firing system is to keep the technical documentation and is to submit it to the authorities or the chimney sweep on request.

Note

Please observe the national and European standards as well as local regulations concerning the installation and operation of firing installations!

Packaging

Your first impression is important to us!

The packaging of your new stove provides excellent protection against damage. However damage to the stove and accessories may still occur during transport.

Note

Therefore please check your stove on receipt for damage and completeness! Report any deficiencies to your dealer immediately! Pay particular attention during unpacking that the stone panels remain intact. Scratches to the material can easily occur. Stone panels are excluded from the warrant.

The packaging of your new stove is environmentally neutral to a great extent.

Tip

The wood used in the packaging has not been surface treated and may therefore be burnt in your stove (not in a pellet stove!). The cardboard and film (PE) can be disposed of via the municipal waste collection for recycling.

Electrical connection

The stove is supplied with an approx. 2m long connecting cable with a Euro-plug. This cable is to be connected to a 230Volt/50Hz socket. The average electrical power consumption is some 20 Watt in heating operation. And approx. 150 Watt during automatic ignition. The connection cable must be laid in a way that there is no contact to any sharp edges or hot surfaces of the stove.

2. IMPORTANT INFORMATION

General warning and safety information

Observance of the introductory general warning information is imperative.

- Read the entire manual thoroughly before installing and putting the stove into service. Observe the national provisions and laws as well as the regulations and rules applicable locally.
- RIKA stoves should only be installed in rooms with normal humidity (dry areas according to VDE 0100 Part 200). The furnaces are not splash water protected and may not be installed in wet areas.
- Only approved transport equipment with sufficient load carrying capacity may be used with your heating appliance.
- Your heating appliance is not suitable for use as a ladder or stationary scaffolding.
- The burning of fuel releases heat energy that lead to extensive heating of the stove surfaces, doors, door and operating handles, glass, flue pipes and possibly the front wall. Refrain from touching these parts without appropriate protective clothing or equipment e.g. heat-resistant gloves or means of operation (operating handle).
- Make your children aware of this particular danger and keep them away from the stove during heating.
- Only burn approved heating materials.
- The combustion or introduction of highly flammable or explosive materials such as empty spray cans etc. in the combustion chamber and storing them near the stove is strictly prohibited due to the danger of explosion.
- No light or inflammable clothing is to be worn when post-heating.
- Use the heat-resistant gloves supplied to open the doors of your stove.
- Make sure that no embers fall out of the combustion chamber onto inflammable material.
- Placing non-heat resistant objects on the stove or near it is prohibited.
- Do not place clothing on the stove to dry.
- Laundry racks etc. must be placed at a sufficient distance to the stove – ACUTE DANGER OF FIRE!
- When your stove is burning, the use of highly inflammable and explosive materials in the same or adjacent rooms is prohibited.
- If the stove is heated in continuous operation, the cleaning intervals are shorter. Increased wear, especially of the thermally stressed parts, is the result. Please therefore strictly follow the requirements for cleaning and maintenance!

Note
Waste and liquids may not be burnt in the stove!

Note
To prevent your stove from overheating of the internal components, do never cover the convection fins!

Note
CAUTION when filling the pellet container. The opening of the pellet container is sufficiently dimensioned to ensure easy filling. Take great care that no pellets drop to the convection fins and the hot stove body. This can cause a lot of smoke.

Tip
Therefore we recommend refilling the pellet container at a cold stove.

Note

Your stove will expand and contract during the heating and cooling phase. This can sometimes lead to slight bending or cracking noises. This is normal and is no reason for a complaint.

First heating

The stove body, just as various steel parts, cast iron parts and the flue pipes are painted with a heat resistant paint. During the first heating the paint dries out completely. This may cause a slight smell. Touching or cleaning the painted surfaces during the curing should be avoided. The hardening of the paint is finished after the first heating with high power.

Safety distances

Note

1. To non-combustible objects
a > 40 cm b > 10 cm
2. To combustible objects and reinforced concrete load-bearing walls
a > 80 cm b > 20 cm

Tip

please observe a minimum distance of 20 cm behind and sideways the stove for maintenance.

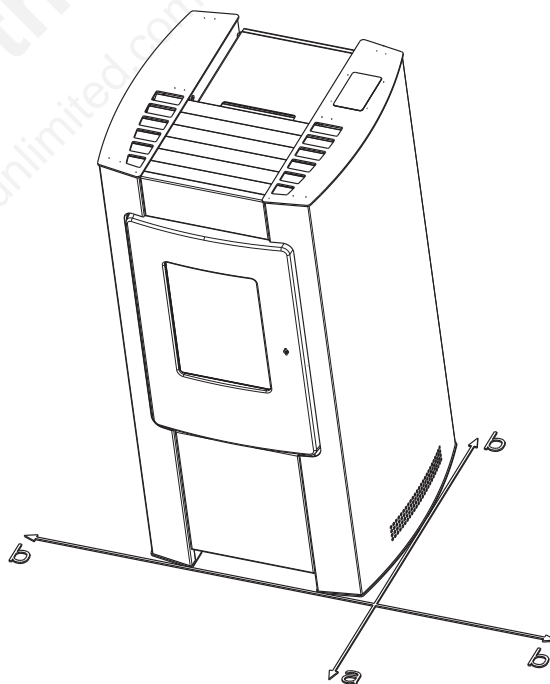

Prior to set up

Floor bearing capacity

Ensure that the substructure is capable of bearing the weight of the stove prior to set-up.

Note

No modifications may be made to the firing installation. This also leads to loss of warranty and guarantee.

Floor protection

A base is recommended (glass, sheet steel or ceramic) if the floor is combustible (wood, carpet, etc.). Please observe the respective local regulations and rules.

Flue pipe connection

- Flue pipes pose a particular source of hazard regarding gas leaks and fire. Get the advice of an authorised specialist company for the layout and assembly.
- Please observe the corresponding installation guidelines for walls panelled with wood when connecting your flue pipes to the stove.
- Observe the formation of flue gas (atmospheric inversion) and draughts when the weather is unfavourable.
- Infeed of too little combustion air can lead to smoke in the rooms or to flue gas leaks. Hazardous deposits in the stove and chimney may also occur.
- If flue gas escapes, let the fire burn out and check whether all the air inlet openings are free and the flue gas pipes and the stove pipe are clean. If in doubt notify the master chimney sweep since draught malfunctions may be connected to your chimney.

Stoves type 1 (BA 1):

- Suitable for multiple occupancy. (Note the different country regulations.)
- These may only be operated with the combustion chamber door closed.
- The combustion chamber door is to be kept closed when the stove is not in operation.
- Fouling of the chimney i.e. deposits of highly inflammable materials such as soot and tar and subsequently fire in the chimney may occur if the chimney is miscalculated and dimensioned wrong.
- If this occurs, disconnect the mains plug. Phone the fire brigade and get yourself and other residents out of harm's way.

Note

on ROOM-AIR DEPENDENT and ROOM-AIR INDEPENDENT OPERATION:

Your stove has been tested as a room-air dependent stove according to EN 14785 and takes all the combustion air via the air intake from the installation room.

In combination with room-air installations (e.g. controlled ventilation and venting systems (extractors etc.) it must be ensured that the stove and the room air system are monitored and safeguarded mutually (e.g. via a differential pressure controller etc.).

The combustion air infeed of approx. 35 m³/h must be ensured.

Please observe the respective local regulations and rules in consultation with your master chimney sweep. For changes after the printing of this manual, we can not assume any liability. We reserve the right to change without notice.

The correct chimney connection

There are several ways to connect your stove to the chimney, eg:

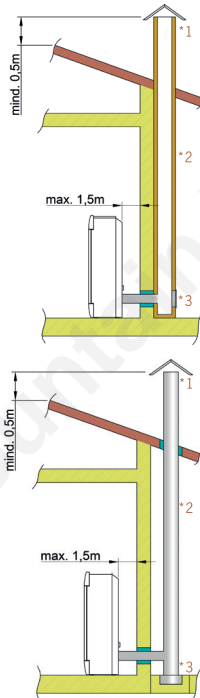

1) wind break, 2) chimney, 3) inspection opening

For the selection of the connection and to ensure a proper connection between the stove and chimney, please read the guide „INSTALLING THE STOVE“ or ask your local chimney sweep.

3. BRIEF INFORMATION ON FUEL - PELLETS

What are pellets?

Wood pellets are a standardised fuel. Every manufacturer must adhere to certain conditions in order to enable flawless, energy-efficient heating. Pellets are made from wooden waste, from sawmills and planing workshops, as well as from residue from forestry operations. These “starting products” are crushed, dried, and pressed into Pellet “Fuel” without any bonding agent.

ENplus – Pellets

This ENplus standard sets benchmarks in the European pellet market. The traceability of pellets is ensured thanks to the use of identification numbers. The pellet manufacturers’ production facilities and manufacturing processes are reviewed every year. A quality assurance system ensures the pellets comply with the requirements of the new standard and that the conditions for trouble-free heating are guaranteed



Wood pellet specification according to ENplus – A1

Parameter	Measure	ENplus-A1
diameter	mm	6 (±1) ²⁾
length	mm	3,15 bis 40 ³⁾
buld density	kg/m ³	≥600
calorific value	MJ/kg	≥16,5
water content	Ma.-%	≤10
fine fraction (<3,15mm)	Ma.-%	≤ 1
mechanical rigidity	Ma.-%	≥97,5 ⁴⁾
ash content	Ma.-% ¹⁾	≤0,7
ash softening temperature	(DT) °C	≥1200
chlorine content	Ma.-% ¹⁾	≤0,02
sulphur content	Ma.-% ¹⁾	≤0,03
nitrogen content	Ma.-% ¹⁾	≤0,3
copper content	mg/kg ¹⁾	≤10
chrome content	mg/kg ¹⁾	≤10
arsenic content	mg/kg ¹⁾	≤1
cadmium content	mg/kg ¹⁾	≤0,5
mercury content	mg/kg ¹⁾	≤0,1
lead content	mg/kg ¹⁾	≤10
nickel content	mg/kg ¹⁾	≤10
zinc content	mg/kg ¹⁾	≤100

1) in an anhydrous state

2) diameter must be specified

3) a maximum of 1% of the pellets may be longer than 40 mm, max. length is 45 mm

4) the limit value of ≥97,7 Ma.-% applies when conducting measurements with a lignotester (internal control)

Your pellet stove is only approved for the burning of pellets of tested quality. Please ask your pellet stove dealer for tested fuel and a list of monitored fuel manufacturers.

Note

Only burn pellets that have been inspected according to ENplus-A1. Using poor quality or prohibited pellet fuel will have a negative effect on the function of your pellet stove and can also lead to the warranty becoming null and void, as well as the product liability connected with this.

Note

Burning straw, maize, woodchips etc. is not permitted! Observe waste incineration legislation! Non-observance of these regulations makes void all warranty and guarantee claims and may impair the safety of the unit!

Pellet container refilling during operation

Note

CAUTION when filling! Avoid direct contact between the plastic bag and the hot stove. Immediately remove all pellets that have fallen on the hot stove or next to the container!

We recommend always having a suitable amount of pellets in the container to prevent the fire from extinguishing due to a lack of fuel. Check the level frequently. However the container lid should be kept closed, except during filling.

If you refill the container during operation (open the container lid), the fan will speed up and the pellet auger will stop; operation will only be continued once the container lid is closed again (see WARNING AND ERROR MESSAGES)

Pellet container capacity (see Technical Data).

Pellet storage

In order to guarantee problem free burning of the wooden pellets, it is imperative necessary to store the fuel as dry as possible and free from impurities.

Pellets should not be kept in sacks outdoors or stored in a manner where they are exposed to the environment. This can lead to blockages in the screw conveyor.

Note

“Screw stoppers” are excluded from the warranty.

4. TECHNOLOGY AND SAFETY FUNCTIONS

The technological advances in your new combi stove are the result of years of testing and practical experience. The practical advantages of your pellet stove are convincing:

Operating comfort

The microprocessor-controlled combustion regulation optimises the interaction of flue gas blower and screw using the current combustion chamber temperature. This guarantees optimum combustion and operating status.

All function can be regulated centrally using the integrated operating unit. The intuitive graphic interface permits easy operation; all the settings can be made quickly and simply.

Top efficiency – lowest emissions

A very great heat exchange surface together with optimum combustion air control leads to excellent fuel utilisation.

Fine continuous pellet dosing in an optimised burner pot made of high-quality grey cast iron leads to virtually complete combustion with very good exhaust gas values - and this is guaranteed in every operating phase.

Note

During operation, the flame noise, pellets dropping and actuation of the electronic components are audible due to the automatic control.

Overheating

A safety temperature limiter (STL) switches the stove off automatically on overheating. Once the stove has cooled, the STB at the stove rear must be unlocked manually (pressed). The stove is ready for operation again after acknowledging the error message at the internal unit.

Note

Maintenance and cleaning work must be performed if overheating occurs! If this error recurs, operation without danger is no longer guaranteed; notify customer service immediately.

Low-temperature shutdown

The unit switches off if the stove cools below a minimum temperature. This switch-off may occur if pellet ignition is delayed.

Electrical excess current protection

The stove has a main fuse (at the rear) to protect against excess current.

Automatic cleaning cycle

The speed of the flue gas fan is increased every hour for a short period to blow ash from the burn pot, increasing the operational safety. The status indicator CLEANING appears on the display.

Only for stoves with turning grids:

Every 6 hours (interval adjustable) an additionally automatic cleaning cycle is performed. The stove stops, the automatic cleaning tilts the grid and then re-ignites the stove. The status indicator CLEANING appears on the display continuously. The cleaning procedure with tilting the grid is to convey ash and clinker from the burn pot into the ash drawer.

Note

This additional function does not replace a manual cleaning as described in CLEANING and MAINTENANCE, as this is absolutely necessary to do regularly.

Note

Due to the turning grid there is a certain generation of noise during the automatic cleaning cycle.

Component monitoring

All the electrical components used are continuously monitored during operation. If a component is defective or can no longer be actuated correctly, then operation is stopped and a warning or error message is issued.

Auger motor monitoring

Too long or wet pellets as well as pellets with too high dust content (see BRIEF INFORMATION ON FUEL PELLETS) can cause so-called “auger jammers” in the auger channel. This may also happen if the pellets accumulate in the burn pot and the backlog reaches into the chute. The auger motor reacts in both cases with an increased current consumption, which causes the error message: DISCHARGE MOTOR BLOCKED. The stove will be stopped. Please call the customer service immediately.

Power failure (during heating)

After a brief power failure, the operating functions that were set before the power failure, continues. If the power failure lasts longer, the stove goes to start phase if sufficient temperature or embers are present. If the power failure lasts too long, the stove goes into the stop phase. The flue gas fan continues to burn any pellet residues (approximately 10 minutes). Then it will restart automatically.

Power failure (during the initial stage)

After a brief power failure the boot process continues. If the power failure lasts longer, the stove is in the stop phase. The flue gas fan continues to burn any pellet residues (approximately 10 minutes). Then it will restart automatically.

5. INSTALLING THE STOVE

General information

Note
Assembly may only be performed by authorised specialist companies.

Note
Please observe the regional safety and building regulations. Please contact your master chimney sweep in this context.

Note
Only use heat-resistant sealing materials as well as corresponding sealing strips, heat-resistant silicon and rock wool.

Note
Also take care that the flue does not project into the free cross-section of the chimney.

Note
In case of room-air independent operation the stove pipe connections must be tightly sealed permanently. Use a heat-proof silicon to position the stove pipe on the conical supports of the flue tube nozzles and for insertion in the chimney flue lining.

Note
The stove should not be pushed on unprotected floors.

Tip
Strong corrugated cardboard, cardboard or e.g. old carpet is useful to assist assembly and as a base. The stove can also be pushed on this cardboard or carpet.

We recommend original flue pipes from RIKA for proper connection.

Connection to the chimney

- The device must be connected to an approved chimney for solid fuels. The chimney must have a diameter of min. 100mm for pellet stoves and 130mm -150mm for log wood stoves depending on the diameter of the flue pipes.
- Avoid long flue pipes to the chimney. The horizontal length of the flue pipe should not exceed 1.5 m.
- Avoid too many bends of the flue gas pipes. There should not be more than 3 bends in the exhaust pipe.
- If you just can not connect directly to the chimney, please use a connection with a cleaning opening.
- Connections must be made of metal and must meet the requirements of the standard (install the connections airtight).
- Before installing a chimney calculation must be made. The evidence must be performed for single occupancy to EN13384-1 and EN13384-2 for multiple occupancy.
- The maximum draft of the chimney should not exceed 15Pa.
- The derivation of the flue gases must be guaranteed even during a temporary power outage.

Note
If connecting to multiple connection chimneys additional safety equipment is required. Your local chimney sweep will advise you in this case.

Note
Be sure to prevent condensed water from entering via the flue connection. You may need to have a condensate ring installed - ask your chimney sweeping expert for more information. Damages caused by condensate are excluded from manufacturer's warranty.

Connecting to a steel chimney

The connection must be calculated and shown with EN13384-1 and EN13384-2.

Use only insulated (double) stainless steel tubes (flexible aluminum or steel tubes are not permitted).

An inspection door for regular inspection and cleaning must be present.

The flue pipe connection to the chimney has to be air-tight.

Combustion air

Every combustion process requires oxygen from the surrounding air. This so-called combustion air is removed from the living area in the case of individual stoves without external air connections.

This air removed must be replaced in the living space. Very tightly sealed windows and doors in modern flats may mean that too little air replaces that used. The situation also becomes problematical due to additional venting in flats (e.g. in the kitchen or WC). If you cannot feed in external combustion air, then air the room several times a day to prevent negative pressure in the room or poor combustion.

Feeding in external combustion air

only for devices which are able to run in room-air independent operation.

- Combustion air must be fed to the stove from outside via a sealed pipe for operation independent of the room air. According to EnEV, it must be possible to shut off the combustion air pipe. The open/closed setting must be clearly recognisable.
- Connect at the air intake either a pipe Ø125mm (log wood and combi stoves) or Ø50mm (pellet stoves) and fix it with a hose clamp (not included!). At pellet stoves with longer intake pipes than 1m the diameter should be increased to 100mm. (see RIKA range).
- To ensure sufficient air intake, the intake pipe should not exceed max. 4m and have max. 3 bends.
- If the line leads outside it must have a windbreak.
- In extreme cold pay attention to icing on the air intake opening (check).
- It is also possible to suction in combustion air directly from another sufficiently vented room (e.g. cellar).
- The combustion air pipe must be tightly connected (adhesive or cement) permanently to the air nozzles of the stove.
- If you do not use the stove for a long time, please close the combustion air intake to prevent the stove from moisture.

Note
Please note that problems may arise due to updrafts in the case of combustion air supply from an integrated chimney ventilation shaft. If the combustion air flowing downwards is heated it may rise and thus counter the chimney with a resistance which in turn reduces the negative pressure in the combustion chamber. The chimney manufacturer is to guarantee that the resistance for the combustion air is a maximum 2 Pa even in the least favourable operating state of the chimney.

If one or more of these conditions does NOT apply, the result is poor combustion in the stove and negative pressure in the installation room.

6. ASSEMBLY/DISMANTLING STOVE AND OPTIONS

Note

Only work on the unit when the mains plug has been disconnected and the stove has cooled completely.

Note

During assembly / dismantling do not allow objects (screws etc.) to fall into the pellet container – they can block the screw conveyor and damage the stove.

Note

During any conversion work, take particular care of your fingers and any panels and stove attachments.
Select soft bases to prevent scratches to your living space furniture and stove panels.

Disassembly of the front side casing

Open the lower front panel by simply lifting. The front panel is simply hooked

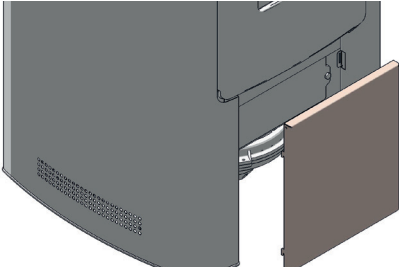

Open the 2 lower hex screws used to secure the side panel

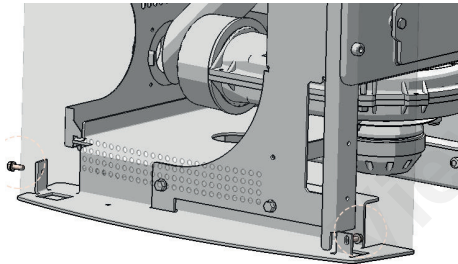

Open the 2 hex screws and the 2 Allen screws used to attach the two covers.
Lift the covers. Make sure that you disconnect the control unit!

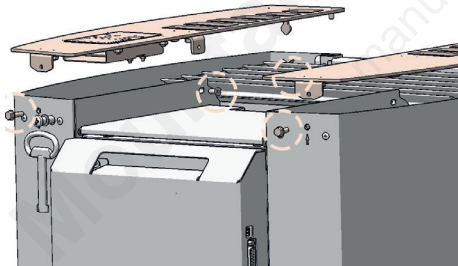

Open the 4 vertical hexagonal screws used to attach the convection fins and lift the convection fins up and away.

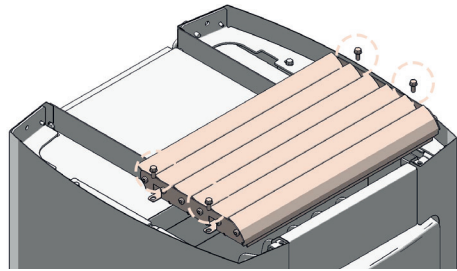

Open the 2 Allen screws used to attach the top panel and lift off the cover upwards.

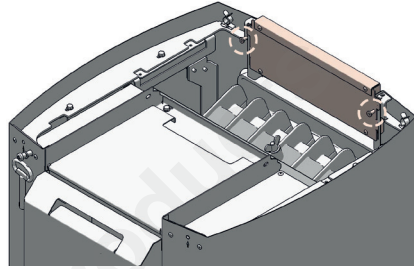

Finally, you can loosen the 4 hex screws that are used to fasten the left and right side panels open, and remove the side panels.

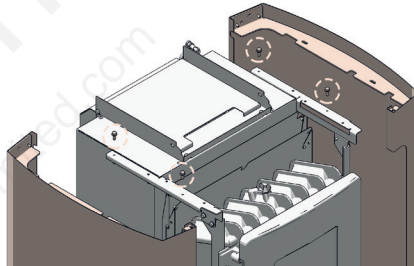

Install the removed parts in reverse order.

7. INTERNAL CONTROLS

The stove has a modern programmable microprocessor control. The individual unit functions can be preset by the user via the internal controls located in the right casing (keyboard with operating display).

Basics

Note

Manipulation of hardware components may only be performed by trained specialist dealers and service. Incorrect handling of these parts leads to loss of warranty and guarantee claims!

Note

The unit may only be put into operation when assembled completely!

Operation

All settings and functions can be controlled via this unit.

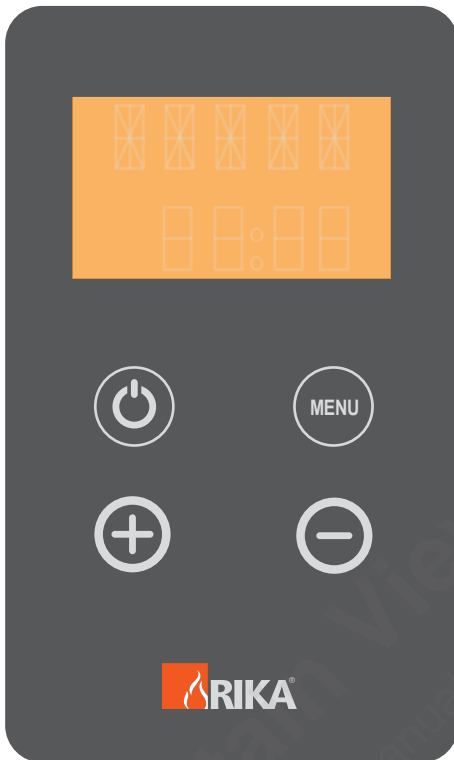

The display is illuminated when touched. After some seconds the display lighting turns off again.

EASY MODE – simple heating operation

Your stove is in simple heating mode EASY OFF when delivered in order to ease your start in the world of RIKA pellet stoves. The heat output of the stove can only be increased or reduced in 5 % increments in this mode. As soon as the stove is connected to the socket, the standard display EASY OFF appears. The message „CHECK“ appears in the display as soon as your pellet stove is connected to the power supply (even after a power failure). The display buttons are disabled for approx. 10 seconds as the stove conducts an initialisation of all components. When „CHECK“ disappears from the display the stove can be started up.

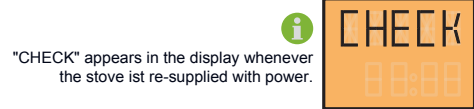

EASY OFF – inactive state

key	display	description
	EASY OFF	Standard display for stove switched off in simple heating mode. The output can also be regulated between 30% and 100% with the stove switched off (EASY 30 – EASY 100).
+	EASY 45	Pressing increases output by 5%
-	EASY 35	Pressing decreases output by 5%

Start – scavenging – tip – ignition

The pellet stove is started in the scavenging phase by pressing the power button. The scavenging phase lasts approx. 50 seconds and is used to eliminate any adverse draft conditions in a cold flue. The grate tips automatically during the scavenging process and any ash leftover from the previous combustion phase falls into the ash tray.

Depending on the fill level of the screw conveyor the ignition process can take approx. 5 to 30 minutes until the first flame is visible.

If the first ignition attempt is unsuccessful, further ignition attempts will be initiated automatically. This may occur if the screw conveyor is not completely full during the ignition process (e.g. first start after refilling empty container).

Note

In the event of a false start remove any unburnt pellets and ash from the combustion cavity. Never replace unburned pellets from the fire pot in the supply container.

FIRE HAZARD DUE TO RESIDUAL EMBERS



Cleaning and tipping during operation

The automatic cleaning process is conducted every hour for approx. 2 minutes. During this phase the air vents that are necessary for combustion are blown clean.

Great cleaning phase (only stoves with automatic turning grid):

The pellet stove enters the burnout phase every 7 hours. A tipping process is conducted automatically. The start-up phase is automatically re-initiated after completion of the burnout phase and operation continues

EASY 40 – switch off

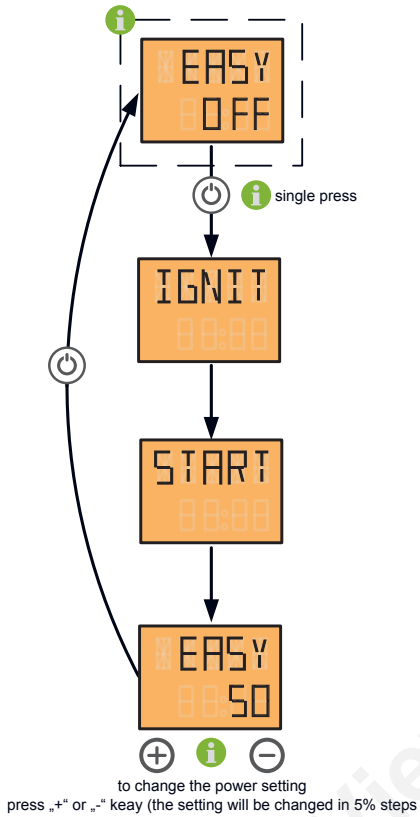

key	display	description
	EASY OFF	
	IGNIT	Pressing  starts the unit.
	START	This is shown by IGNITE in the display; this is replaced by START after a brief time.
	EASY xx	EASY xx appears in the display after the start phase (xx stands for a value between 30% and 100%, depending on output)

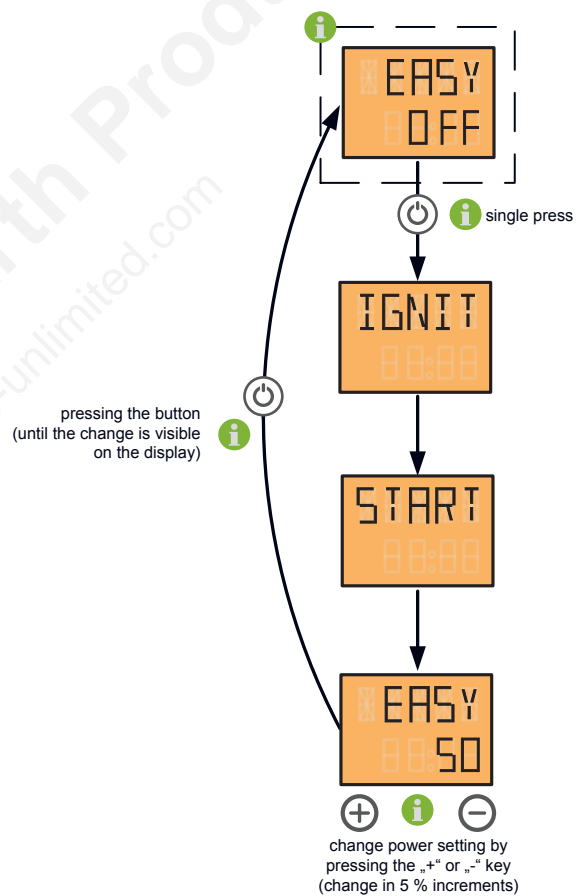

key	display	description
	STOP EASY OFF	The burnout phase is initiated by pressing for at least 2 seconds (until the change is visible on the display). The pellet support stops - the flue gas fan continues to burn any pellet residues (approximately 10 minutes). The stove changes to EASY OFF.





Stopping during ignit or startphase

If switching off occurs again 50 sec. within switching on (-key) (at least 2 sec. -key), the pellet stove returns to inactive status.

If switching off occurs during the ignition process (IGNIT or START) (at least 2 sec. -key), IGNIT OFF or START OFF appears in the display and the burn-out phase is initiated. The pellet support stops - the flue gas fan continues to burn any pellet residues (approximately 10 minutes). The stove changes to EASY OFF.

EASY 40 – operation

key	display	description
	EASY 40	Standard display for stove switched on in simple heating mode. (40 is the output in %)
	EASY 45	Pressing increases output by 5%
	EASY 40	Pressing decreases output by 5%

Extended heating operation - HEAT MODE - comfort functions

In addition to the basic functions of simple heating operation, the RIKA pellet stove provides extra comfort functions. However, before you can use the comfort functions such as frost protection and child safety device, or the optional functions such as an external room thermostat or regulation of the stove via mobile phone, you have to change from simple heating to comfort mode.

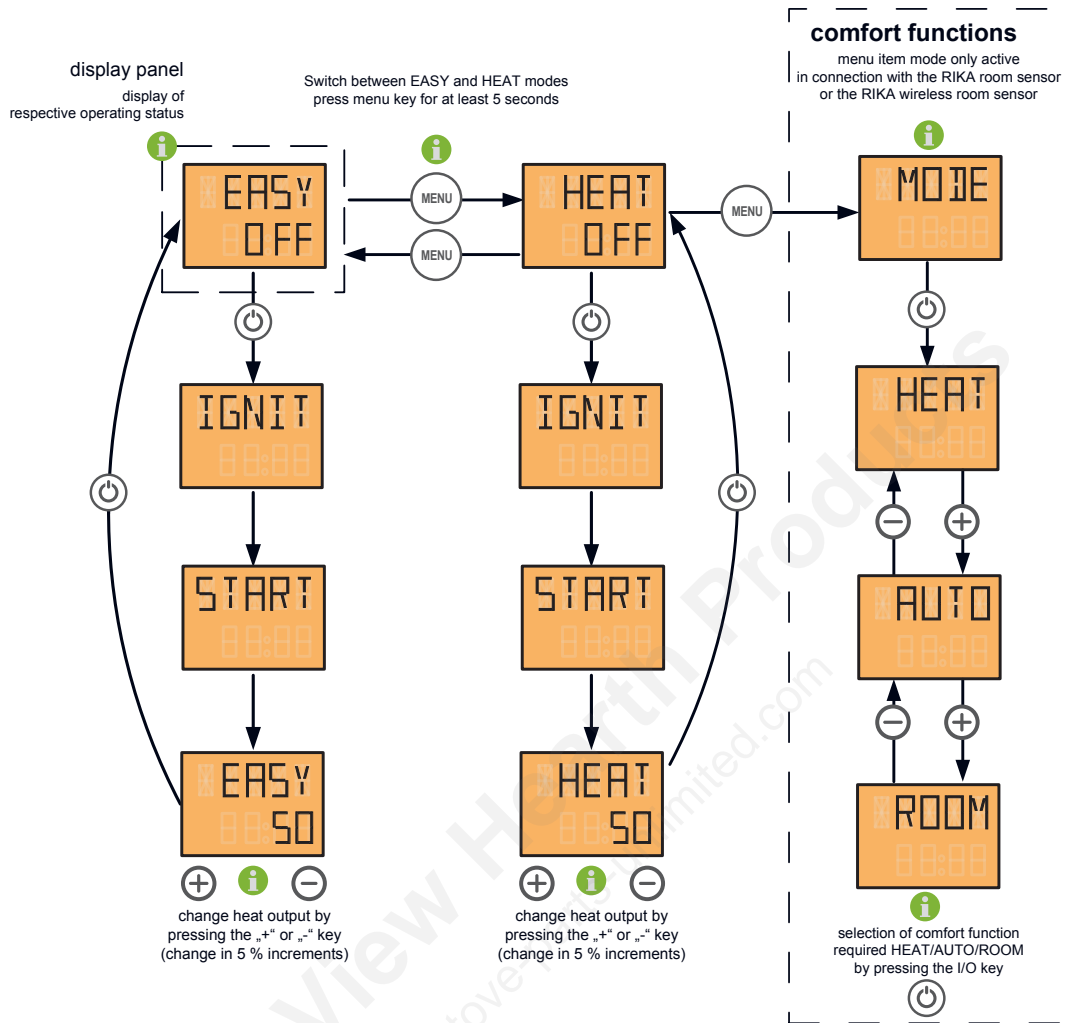

key	display	description
	EASY OFF	Standard display for stove switched off in simple heating mode.
		Pressing for at least 5 seconds changes to HEAT mode. The change is also shown in the display as confirmation.
	HEAT OFF	Standard display for stove switched off in extended heating mode. (comfort functions can now be selected)
		Pressing once changes to display MODE
	MODE	You can select one of three possible stove comfort functions. (the menu item Mode is only active in connection with the RIKA room sensor or the RIKA wireless room sensor active).
		Pressing once takes you to the comfort function selection and you can change between the individual comfort functions using keys and .
	HEAT	
	AUTO	Pressing again confirms the comfort function currently visible HEAT, AUTO or ROOM.
	ROOM	

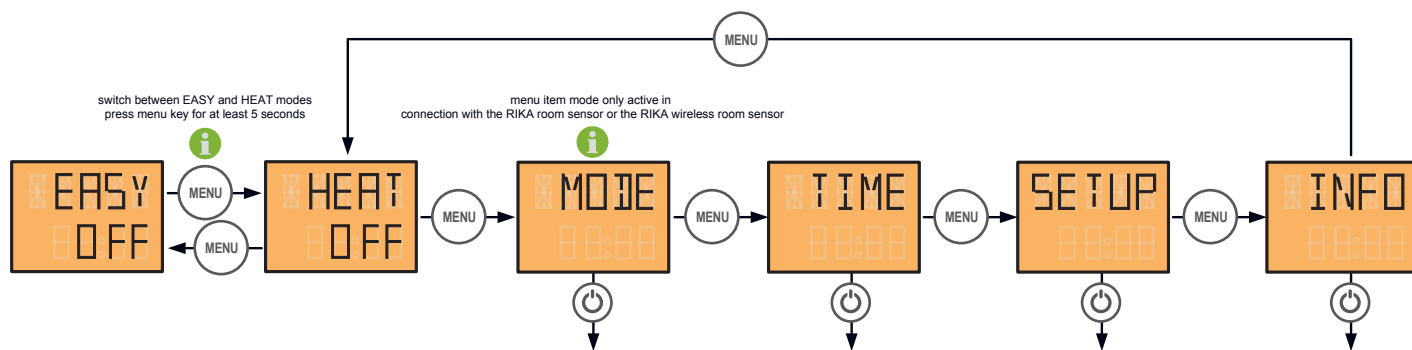









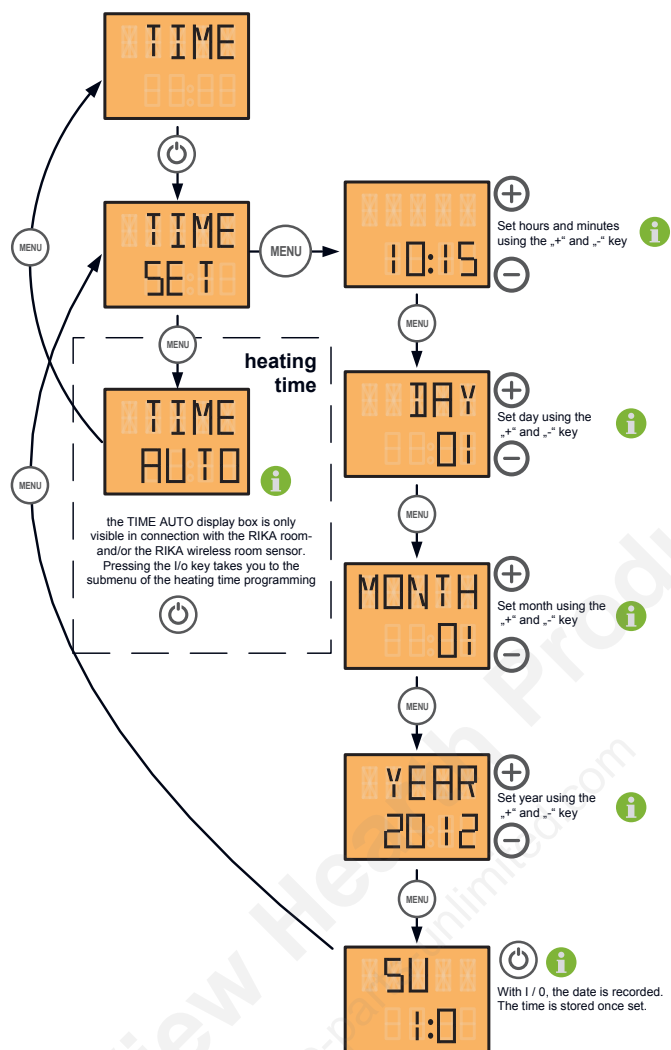









key	display	description
	EASY OFF	Standard display for stove switched off in simple heating mode.
MENU		Pressing for at least 5 seconds changes to HEAT mode. The change is also shown in the display as confirmation.
	HEAT OFF	Standard display for stove switched off in extended heating mode.
MENU		Pressing once changes to display MODE
	MODE	You can select one of three possible stove comfort functions. (The menu item Mode is only active in connection with the GSM option, the RIKA room sensor and/or the RIKA wireless room sensor active, also see “Extended heating operation – comfort functions”).
MENU		Pressing once changes to display TIME
	TIME	Setting regarding the time are made here. (Heating time is only available with RIKA room sensor or RIKA wireless room sensor).
MENU		Pressing once changes to display SETUP
	SETUP	All the additional functions can be regulated here.
MENU		Pressing once changes to display INFO
	INFO	Access to information menu, various system parameters, temperatures and operating information can be called up here.
MENU		Pressing once changes to display HEAT OFF
	HEAT OFF	Standard display for stove switched off in extended heating mode.
MENU		Pressing for at least 5 seconds changes to EASY mode. The change is also shown in the display as confirmation.
	EASY OFF	Standard display for stove switched off in simple heating mode.

Pressing once on the respective main menu items MODE, TIME, SETUP and INFO selects the submenu items.

The individual main menu items TIME, SETUP and INFO are explained in more detail on the next pages.

The menu navigation described above remains the same during operation. The respective heat output set is shown in the display instead of EASY OFF or HEAT OFF. For example EASY 30 or HEAT 30



key	display	description
	TIME	Display to enter the control level for time adjustment.
	TIME SET	All the settings concerning time, date and heating time (optional) are made here.
	00:00	Setting the time. Hour display is changed using  , minute display using  .
	DAY 01	Setting the day. Display is changed using  and  .
	MONTH 01	Setting the month. Display is changed using  and  .
	YEAR 2012	Setting the year. Display is changed using  and  .
	SU 1:0	The actual day is shown in the display as confirmation.
	TIME SET	Back to TIME SET.
	(TIME AUTO)	(Setting the heating times. The menu item TIME AUTO only appears in connection with the RIKA room sensor and the RIKA wireless room sensor). (Please see the operating instruction enclosed for the option for setting the heating times).
	TIME	Back to TIME.
		Repeated pressing returns you to the main menu level.









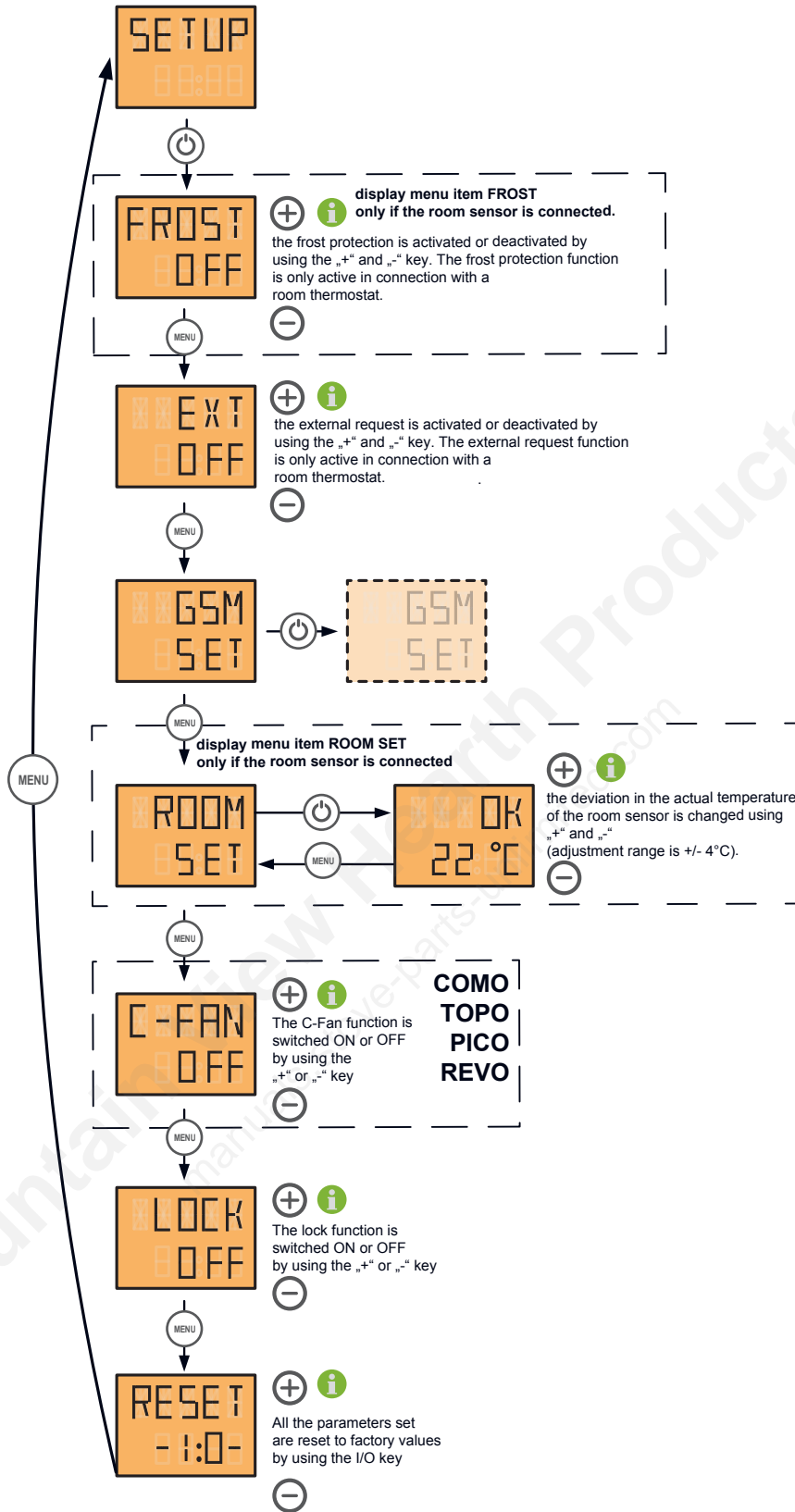













Note

Summer- and wintertime is not changed automatically



Mountain View Hearth Products
manuals.stove-parts-unlimited.com



key	display	description
	SETUP	Display to enter the control level for additional functions. You can change between the operating status On (active) and OFF (inactive).
	FROST OFF	Display of operating status of additional function FROST, frost protection (only in connection with RIKA room sensor and RIKA wireless room sensor). Using  and  you can switch between FROST OFF (inactive) and FROST ON (active). Frost protection is only active in combination with the comfortfunctions HEAT OFF, ROOM OFF and AUTO OFF. Starting temperature 8°C, stopping temperature 13°C
	EXT OFF	Display of operating status of additional function EXT external unit such as e.g. a customary room thermostat (see Comfort function – external room thermostat for more information). Using  and  you can switch between EXT OFF (inactive) and EXT ON (active)..
	GSM SET	All settings concerning Telephone option – GSM are made here. Pressing  takes you to the submenu of Telephone option – GSM. Please see the operating instructions accompanying the Telephone option – GSM for settings.
	ROOM SET	The room temperature displayed may deviate from the actual temperature and therefore the sensor may be calibrated by +/- 4°C. Thus the actual temperature of the room sensor can be adjusted e.g. to the house thermometer.
	C-FAN OFF	Display of the operating status of the optional cross-flow fan. You can switch between C-FAN OFF (inactive) and C-FAN ON (active) by pressing  and  .
	LOCK OFF	Display of operating status of additional function LOCK child safety device (key lock). Using  and  you can switch between LOCK OFF (inactive) and LOCK ON (active). To lock the keyboard with active child protection device (LOCK ON), press  and  at the same time for at least 5 seconds in the standard mode EASY or HEAT. LOCK appears in the display as confirmation. To unlock the keyboard again press  and  at the same time for at least 5 seconds. LOCK OFF appears in the display as confirmation.
	RESET - 1:0 -	Any settings changed can be reset to the delivery status here. Pressing  resets the stove to the factory settings.
	SETUP	Display to enter the control level for additional functions. You can change between the operating status On (active) and OFF (inactive).
		Repeated pressing returns you to the main menu level.

Mountain View Hearth
manuals.stove-parts-unlimited.com

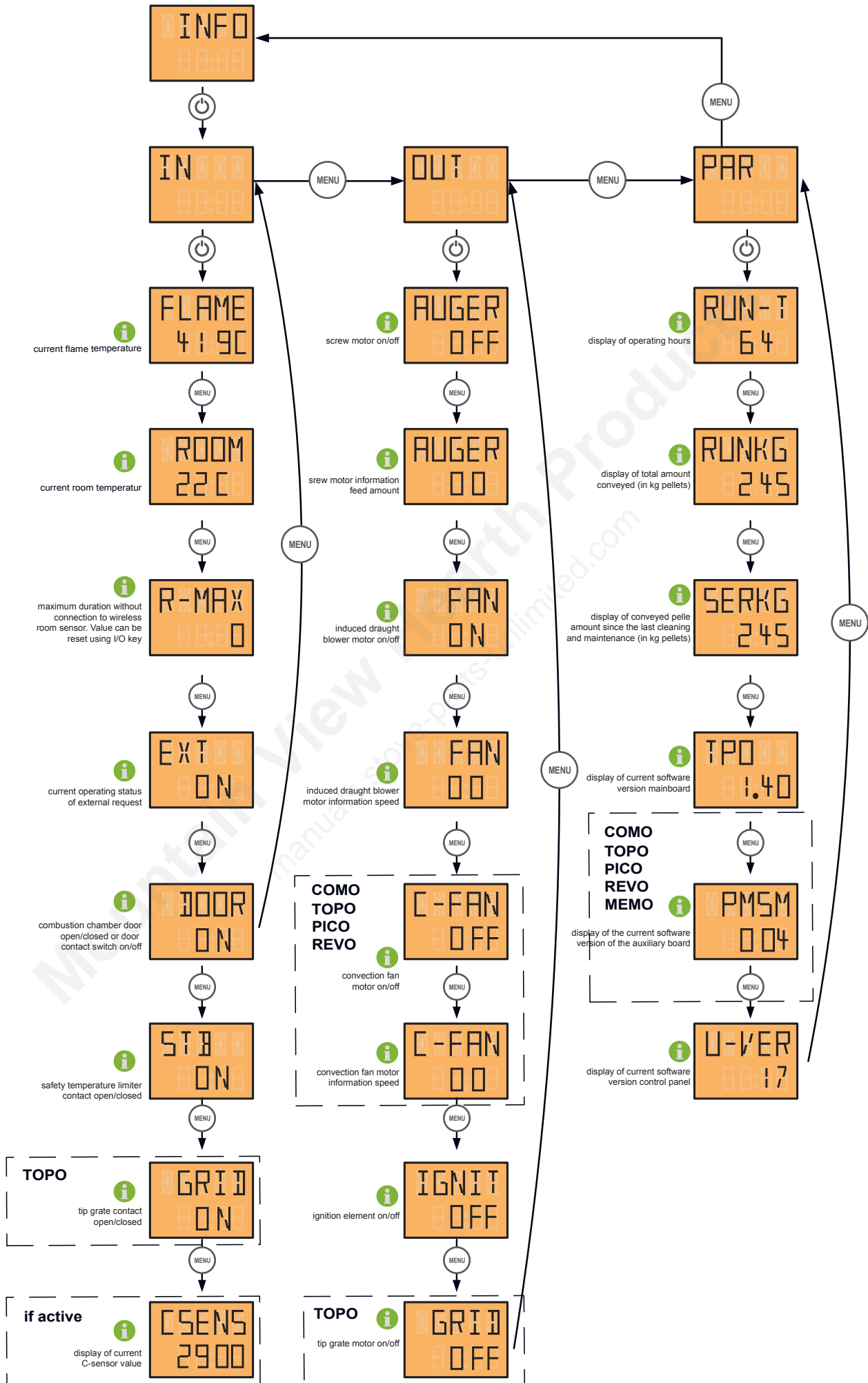

key	display	description
	INFO	Access to information menu, various system statuses, temperatures and operating information can be called up here.
	IN	INFORMATION INPUTS
	FLAME 319	Display of current flame temperature
	ROOM 22	Display of current room temperature
	R-MAX	Display menu maximum duration without connection to wireless room sensor
	EXTON	Display of status of external release (ON or OFF)
	DOOR ON	Display of the status of door contact (ON or OFF)
	STB ON	Display of the status of safety temperature limiter (ON or OFF)
	GRID ON	Status display for the mudhole door contact (ON or OFF)
	IN	INFORMATION INPUTS
	OUT	INFORMATION OUTPUTS
	AUGER OFF	Display of operating status of screw motor (ON or OFF)
	AUGER 0	Display of actual push-in rate
	FAN ON	Display of operating status of flue gas blower (ON or OFF)
	FAN 0	Display of speed of flue gas blower
	C-FAN OFF	Display of the operating status of the optional cross-flow fan (ON or OFF)
	C-FAN 0	Display of the speed of the cross-flow fan
	GRID OFF	Display of the operating status of the mudhole door motor (ON or OFF)
	IGNIT OFF	Display of operating status of ignition element (ON or OFF)
	OUT	INFORMATION OUTPUTS
	PAR	INFORMATION PARAMETER
	RUN - T 63	Display of previous total operating hours
	RUNKG 245	Display of total pellet amount supplied up to present
	SERKG 245	Display of conveyed pellet amount since the last cleaning and maintenance
	TPO 0144	Display of current software version loaded on control board (Scrolling text)
	PMSM-VER 004	Display of the current software version of the auxiliary board (Scrolling text)
	U-VER 17	Display of current software version loaded on control unit
	PAR	Repeated pressing returns you to the main menu level.

8. COMFORT OPTIONS

We would point out that auxiliary units may only be connected to the RIKA interface connection and external connection socket by authorised specialists.

RIKA room sensor/RIKA radio room sensor

This option permits control of your stove via room temperature. You can set both the room temperature and the heating times required. A room temperature selected by you is observed during the heating times.

Please see the operating instructions for the option RIKA room sensor and wireless room sensor for more detailed information.

RIKA phone option – GSM

Your stove can also be controlled via a mobile phone as an additional option.

Please see the operating instructions for the telephone option – GSM for more detailed information.

RIKA interface for various options

for various options

The RIKA ROOM SENSOR, the RIKA WIRELESS ROOM SENSOR and the RIKA PHONE OPTION – GSM are to be connected to the interface (stove rear) using the connection cable supplied.

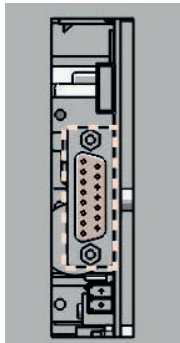

External room thermostat

Your stove has an interface on the rear wall to which you can connect a customary room thermostat. This requires a 2-pole cable of 0.5 – 0.75 mm² cross-section that you have to connect instead of the cable bridge fitted for delivery

External connection cable bridge

(condition as delivered)

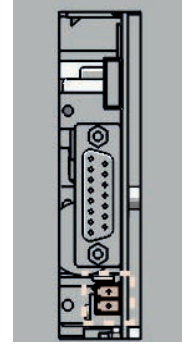

The stove settings in the menu item Setup are to be checked to ensure the function of the room thermostat. The external unit must be set to EXT ON (active) as described above.

This function enables you to deactivate a connected room thermostat (setting EXT OFF).

All further settings required to your thermostat can be taken from the room thermostat operating instructions.

The connected room thermostat must be operated in the HEAT menu. You can select the heat output you wish for the room temperature selected.

If an external demand for stopping the pellet stove occurs, it takes about 5 minutes until the pellet stove switches to burn out phase.

Note

Operation is not possible unless either a cable bridge or an external room thermostat is connected. The external demand has priority over all operating modes (EASY/HEAT/AUTOMATIC/ROOM).



9. MODES

Note

When operated correctly, your stove can not overheat. Improper operation may shorten the life expectancy of electrical components (blowers, motors and electric control) and is not allowed!

Pellet operation Heat/Easy/Automatic/Room

HEAT/EASY

The pellet burner start and stop as well as the setting of the required heat output are executed directly in the HOME – main menu.

AUTOMATIC MODE

The change between standby operation and neutral as well as the setting of the required heat output are executed via the display in the HOME – main menu.

The pellet burner starts in standby mode within the heating times when the actual room temperature is below the set room temperature (ON-T), or outside of the heating times when the actual room temperature is below the setback temperature (OFF-T).

When achieving the set room temperature, the pellet burner stops.

Stove start is not possible in neutral status (OFF), the system is switched off.

ROOM MODE

The change between standby operation and neutral as well as the setting of the required heat output are executed via the display in the HOME – main menu.

The pellet burner starts in standby mode if the actual room temperature is below the set room temperature.

When achieving the set room temperature, the pellet burner stops.

Stove start is not possible in neutral status (OFF), the system is switched off.

Pellet container refilling during operation

Note

CAUTION when filling! Avoid direct contact between the plastic bag and the hot stove. Immediately remove all pellets that have fallen on the hot stove or next to the container!

We recommend always having a suitable amount of pellets in the container to prevent the fire from extinguishing due to a lack of fuel. Check the level frequently. However the container lid should be kept closed, except during filling.

If you refill the container during operation (open the container lid), the fan will speed up and the pellet auger will stop; operation will only be continued once the container lid is closed again (see WARNING AND ERROR MESSAGES)

Pellet container capacity (see Technical Data).

Emergency operation – heating up without electrical Ignition

If the ignition cartridge fail, firelighters can be used for an emergency operation. First, start the stove as usual. Wait for the turning of the grid (only for units with turning grids). Then open the combustion chamber door and give a handful of pellets with the firelighter into the clean burn pot, light it up and close the combustion chamber door.

Note

Do not use flammable liquids to light up the fire!

10. MENU OVERVIEW V1.40

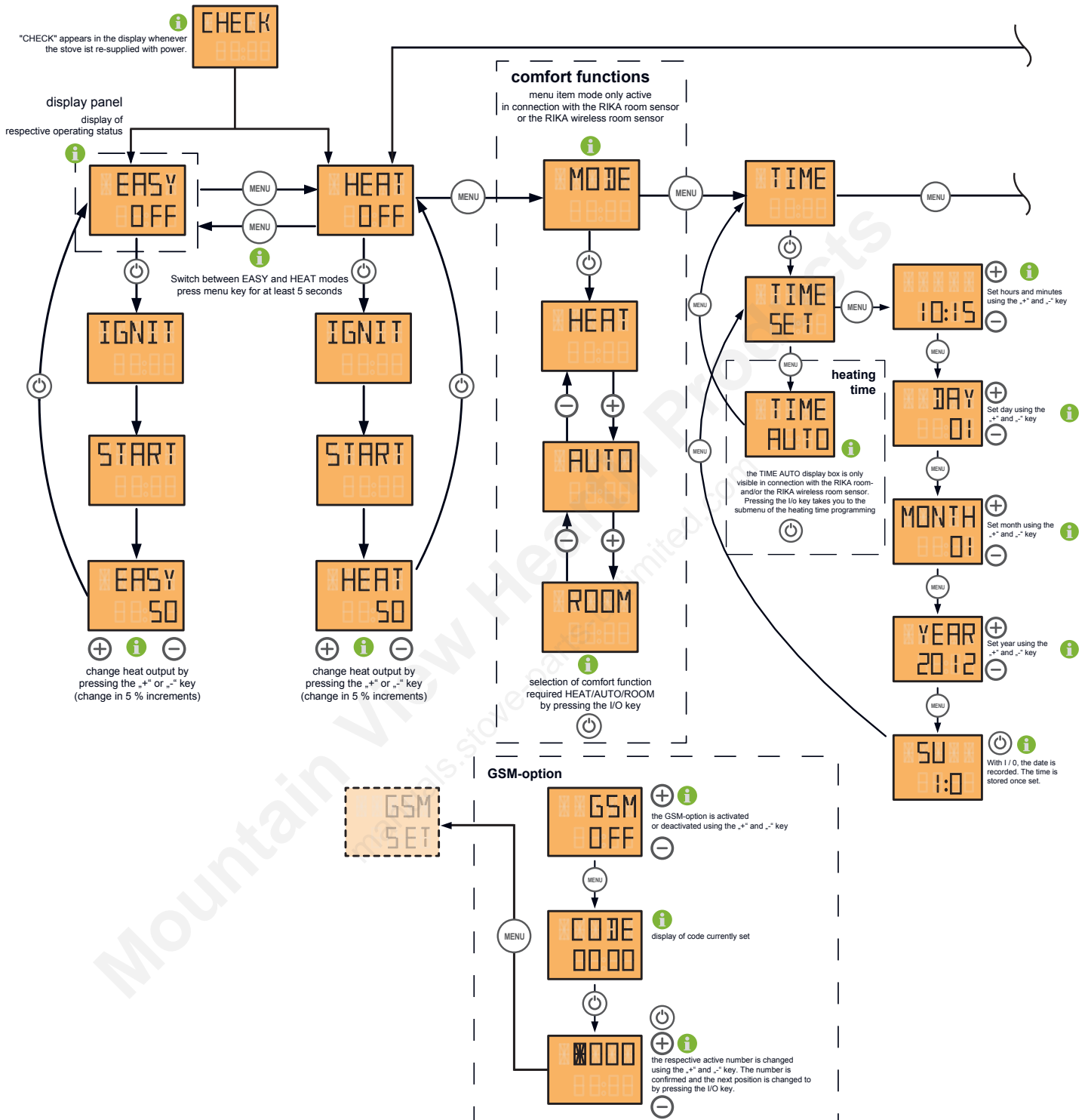

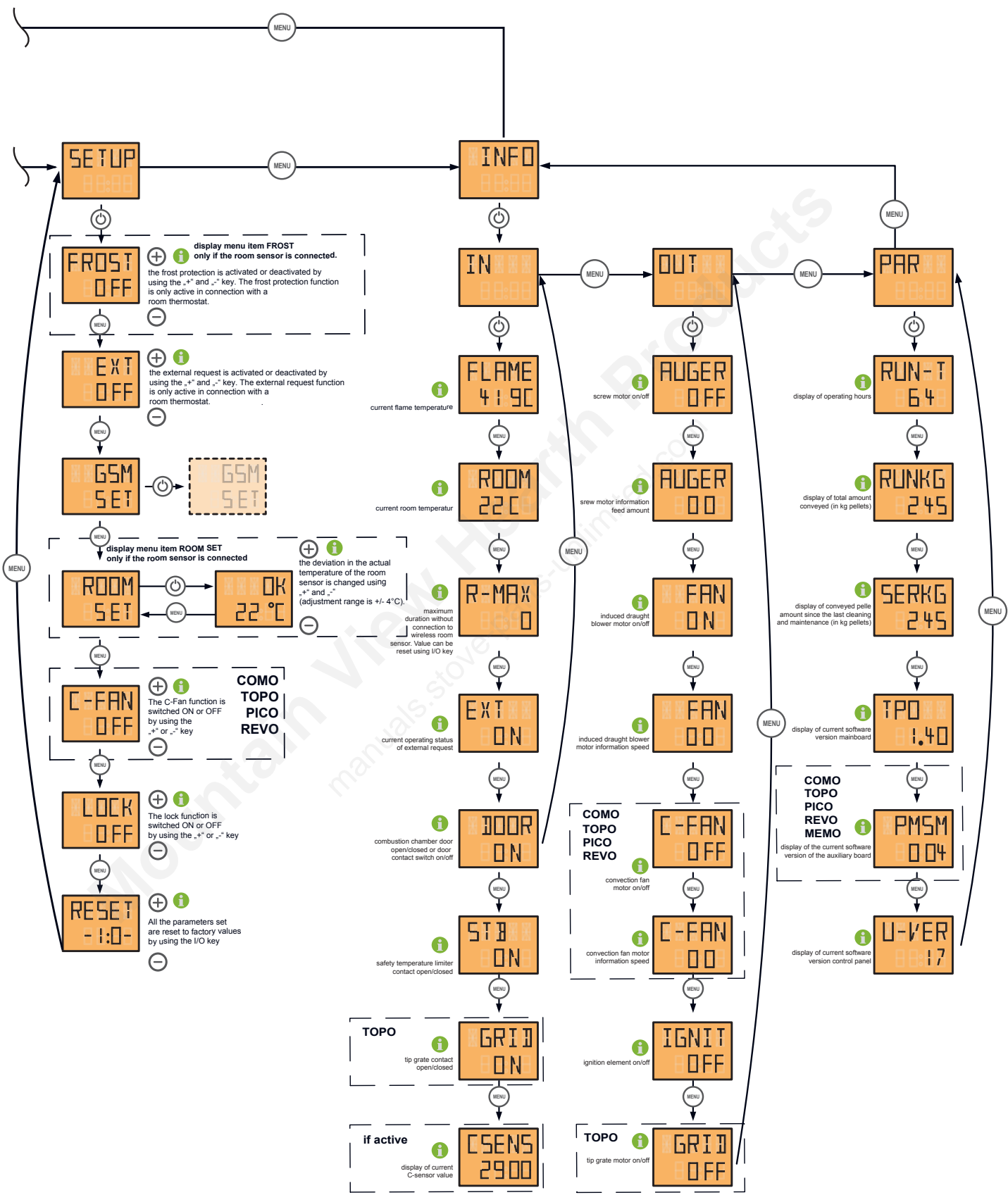

11. WARNINGS AND ERROR MESSAGES



If a malfunction occurs, the main menu is switched to and the malfunction is displayed in marquee. The malfunction is acknowledged by pressing  for at least 2 seconds.

The button must be depressed until the change in the operating status appears on the display.

Note

If error messages recur directly, customer service is to be notified immediately. In the case of error messages that pose a safety risk, burnback and flue gas flap is activated and the stove is automatically switched off



Display	Malfunction designation	Cause / remedy
STB >I/O<	Safety temperature limiter is activated	Establish cause of activation; eliminate this and reset using reset button directly at STB. The error message must then also be acknowledged. Only with cooled stove.
NO PELLETS >I/O<	No pellets in container	May also occur on first start (first filling). Check whether there are sufficient pellets in the container and re-start unit after acknowledging malfunction. - Screw conveyor blocked - Flame sensor sleeve dirty - Chimney draught too great
FAN DEFECT >I/O<	Flue gas blower defective	Acknowledge the error message.
FLAME SENSOR DEFECT >I/O<	Flame sensor defective	Acknowledge the error message.
ROOM SENSOR SIGNAL LOST >I/O<	Rika room sensor reception defective	Transmission between the transmitter and receiver has been lost. If the error message appears again immediately after re-starting the device, it means either the battery is flat or the component is defective.
SERVICE >I/O<	Pellet amount for cleaning and maintenance exceeded	Acknowledge the message and perform cleaning or maintenance procedures (see CLEANING AND MAINTENANCE).
CALL SERVICE MOTOR	Pellet backlog	Overfilling of the combustion cavity with a subsequent backlog of pellets in the drop chute has been detected. Remove any encrustations in the burn pot. The error message can be acknowledged by pressing the  and  button simultaneously (held until the error message disappears).
DOOR OPEN >I/O<	Door open	Check to make sure the door is closed and that the door contact switch engages. (The DOOR OPEN message doesn't need to be acknowledged; the display will disappear when the door is closed.)
AUGER-PMSM DEFECT >I/O<	Screw motor defective	Acknowledge the error message.

12. MAINTENANCE

The frequency with which the stove requires cleaning and the maintenance intervals depend on the fuel you use. High moisture content, ash, dust and chips may more than double the maintenance required. We would like to point out again that only tested and recommended pellets may be used as fuel.

Tip

Wood as fertiliser - the mineral content of the wood remains in the combustion chamber as ash as a residue of the combustion. This is an excellent fertiliser for all plants in the garden; it is a completely natural product. The ash should be stored first and slaked with water.



Note

Ash may contain embers – only place ash in steel sheet containers!



Open the combustion chamber door

To open or close the combustion chamber door use the included key. This key can be stored on the back of the stove when not in use.

Cleaning of the burn pot - daily

Make sure that the air vents are not blocked with ash or clinker. Remove the clinker using the supplied brush and vacuum the burn pot. The burn pot can be easily cleaned inside the stove. After removing the pot the area underneath can be vacuum-cleaned.

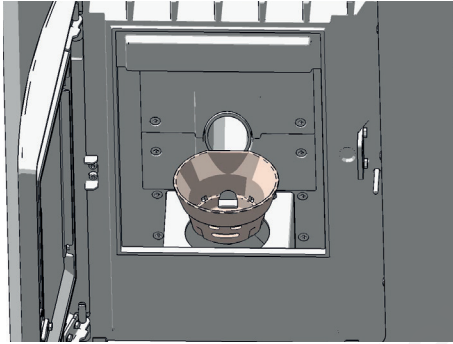

Do not damage the ignition when cleaning with the brush.

Note

Clean the fire trough regularly. Only clean when cold, when embers are extinguished!



Note

If the stove is heated in continuous operation, it must be cleaned 2x within 24 hours. FIRE HAZARD!



Cleaning the flame temperature sensor

Remove the dust deposits from the sensor at regular intervals. Use a clean cleaning cloth or newspaper.

Cleaning the door glass

The viewing window becomes coated in the case of solid fuels, particularly with the very fine ash of wood pellets, light or dark depending on the pellet quality (especially with low output). The glass can be cleaned best with a moist cloth. Stubborn dirt can be removed with a special cleaner available from your stove dealer. Usual cleaners containing acid or solvents can be too harsh and damage the glass.

Cleaning painted surfaces

Wipe the painted surfaces with a damp cloth, do not scrub. Do not use solvent-containing cleaners.

13. CLEANING

Tip

Your RIKA dealer will gladly advise you about their service and maintenance offers.

Depending on pellet consumption, a message prompting cleaning of the stove appears on the display in regular intervals. This message can be acknowledged on the Touch Display, while continuing operation. Perform a cleaning cycle at the next opportunity.

Subsequently, reset the counter in the SETTINGS menu / RESETS submenu, as per operating instructions of TOUCH DISPLAY.

Tip

The message will only stop reappearing once you have reset the feed volume in the SETTINGS / Resets menu.

Note

Your stove must be switched off and cooled before any maintenance work is performed. Only work on the unit when the mains plug has been disconnected.

Cleaning the convection air openings

Vacuum clean any dust deposits from the convection air openings at regular intervals.

The stove should be cleaned thoroughly prior to the start of the heating season to prevent excess odour.

Note

To prevent your stove from overheating of the internal components, do never cover the convection fins!

Combustion air – intake

If necessary, please also clean the air intake with a Hoover.

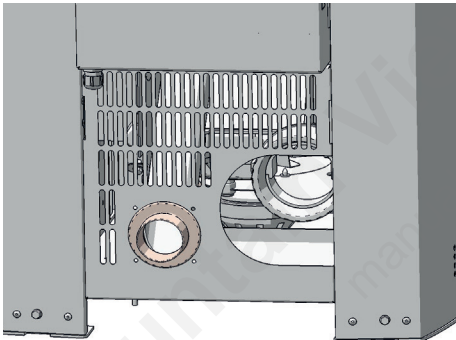

Note

Only when the stove is cold! You could vacuum out embers – FIRE RISK!

Cleaning the flue gas channels and flue gas collecting duct

Open the lower front panel by simply lifting. The front panel is simply hooked.

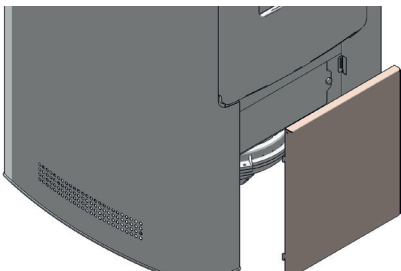

Open the 2 lower hex screws used to secure the side panel.

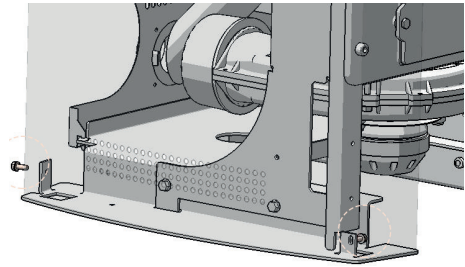

Open the 2 hex screws and the 2 Allen screws used to attach the two covers. Lift the covers. Make sure that you disconnect the control unit!

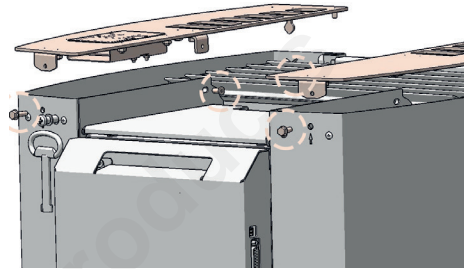

Open the 4 vertical hexagonal screws used to attach the convection fins and lift the convection fins up and away.

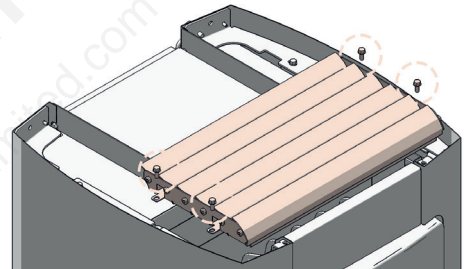

Open the 2 Allen screws used to attach the top panel and lift off the cover upwards.

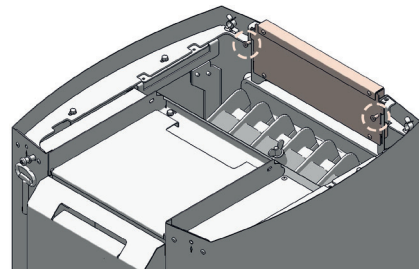

Open and remove the wing nut, which serves to secure the firebox lid. For ease of disassembly, hold against the screw through the combustion chamber.

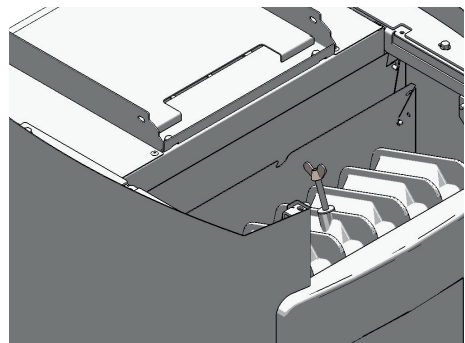

You can now pull the firebox lid upwards.

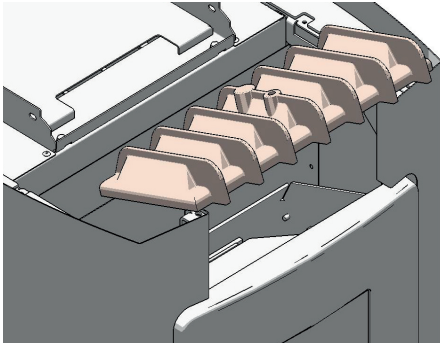

Now clean the flues on the fire side with the supplied wire brush.

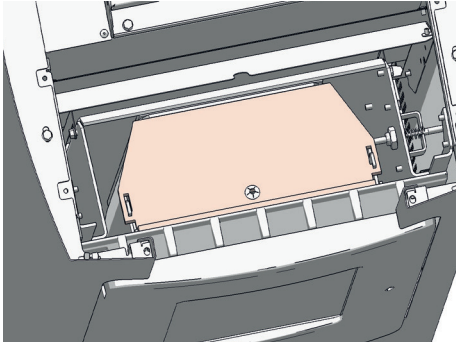

Suck free the exposed interior and the side passages of impurities.

After cleaning, the flue gas passes remove the debris from the flue gas collection channel!

Remove the cover plate by opening the hexagon screws.

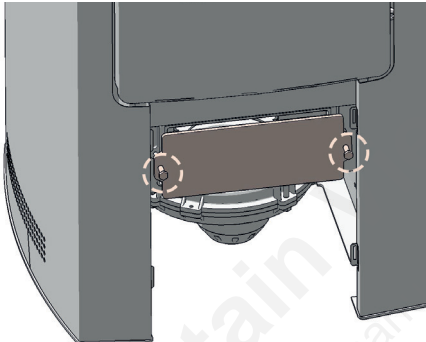

Suck out the combustion residues from the flue gas collection channel.

Install the removed parts in reverse order.

Note

Your stove may suck in false air via incorrectly sealed cleaning covers; this air may lead to incomplete combustion in the fire trough and thus piling up of pellets. DANGER of FIRE!

To ensure the proper operation of your pellet stove, replace any defect (porous, frayed) seals after cleaning and maintenance.

Clean flue gas fan housing

The flue gas fan and the flue pipe connection should be cleaned at least 2 times a year, or after about 700 kg of pellets.

To inspect and clean the flue gas fan, the back wall has to be removed.

The four screws that secure the flue gas fan motor have to be opened and the motor is carefully pulled out of the case.

Remove with a vacuum cleaner the ash from the fan and flue gas pipes. When closing again definitely pay attention to leaks.

For cleaning the flue pipe connection, pull the flue pipe from the flue gas fan and suck out the blower housing.

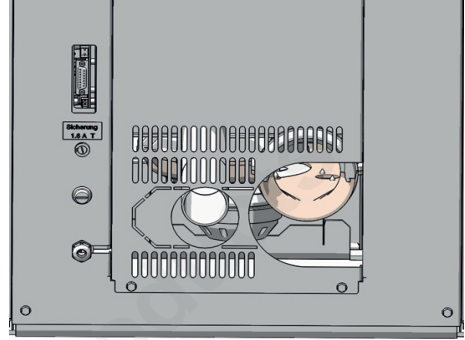

Cleaning the pellet container

Do not refill the completely empty container immediately; remove the residues (dust, chippings etc.) from the empty container. The unit must be disconnected from the mains!

Bearings

(annually)

All built-in bearings (pellet screw) should be checked. Clean or replace bearings depending on condition.

Cleaning the flue pipes

(annually)

Remove the flue pipes. Inspect and clean the chimney connection. Brush off any soot and dust deposits in the fire and in the flue pipes and vacuum.

Note

Accumulated fly ash in the flue gas channels may impair the performance of the stove and pose a safety risk.

Checking door seal

(annually)

The condition of the seals at doors and glass should be checked at least once a year. Repair or replace seals depending on condition.

Note

Only intact seals ensure your stove works perfectly!

14. PROBLEMS - POSSIBLE SOLUTIONS

Problem 1

Fire burns with weak, orange flame. Pellets heap up in fire trough, window soots up.

Cause(s)

- Insufficient combustion air
- Poor chimney draught
- Stove is sooted over inside

Possible solutions

- Remove any ash or clinker from the fire trough that may block the air inlets. (see CLEANING and MAINTENANCE)
- If possible swap to better pellet quality.
- Check whether flue gas pipes are blocked with ash (see CLEANING and MAINTENANCE).
- Check whether the air intake or flue tubes are blocked.
- Check door and cleaning cover seals for leaks (see CLEANING and MAINTENANCE)
- Clean fan (see CLEANING and MAINTENANCE)
- Have service performed by authorised specialist company.
- The window has to be cleaned from time to time (see CLEANING and MAINTENANCE)

Problem 2

Stove smells strongly and smokes outside.

Cause(s)

- Burning-in phase (taking into service)
- Stove has accumulated dust and/or dirt

Possible solutions

- Wait to end of burning-in phase and vent the room sufficiently.
- Vacuum off any dust deposits from the convection air openings at regular intervals

Problem 3

Flue gas discharge when wood is added and during heating phase.

Cause(s)

- Leaking cleaning openings
- Chimney draught too low
- Leaking flue pipe connection

Possible solutions

- Check seals and replace (fire door, cleaning lid, ..)
- Check chimney
- Check connections and if necessary re-seal

Note

Please note that checks on the control system and wiring may only be performed in unit switched dead. Any repairs may only be performed by trained specialists.

Tip

If a malfunction message occurs, the cause must first be remedied; the unit can be put back into operation by acknowledging the malfunction at the internal unit.

15. INSTRUCTIONS FOR COMMISSIONING PROTOCOL

FOR PELLET AND COMBI STOVES

The commissioning protocol is to be treated as a document and serves as the basis for the warranty and guarantee terms. It is to be completed entirely, in particular the stove data and addresses, the work to be performed is to be ticked off after completion. The signatories confirm with their signatures that all the items on the list have been concluded properly.

Note

Please return 1 completed protocol for putting into service to RIKA Innovative Ofentechnik GmbH, Müllerviertel 20, 4563 Micheldorf, Austria.

Electrical periphery

It is important that the connection socket in the electrical periphery is earthed. The operability of any room thermostat present must be checked. The execution of commands is to be established by phoning in the case of a GSM modem.

Exhaust gas system

The exhaust line, stove and combustion air inlet are part of the combustion system as a whole; therefore the correct execution must also be checked. The plug connections should be tight in general since the system works with excess pressure. The exhaust tube has a diameter of 100mm for pellet stove, and of 150 mm for the combi stove, which is sufficient for short distances. In the case of several changes in direction, the resistance of the exhaust system can increase with the flue to such an extent that the combustion quality suffers and/or noise arises from the greater flow speed. Correct determination of the chimney draught can only be performed at nominal thermal output and serves to evaluate the chimney. If the draught is more than 15 Pa, then a draught limiter should be installed.

Stove functions

These are the basic stove functions that are to be checked and ticked off. The stove is ready for operation if these functions are ensured.

Operator instruction

This is one of the most important points in the putting into operation. It is very important that the operator understands the stove properly and is prepared to assume responsibility for the basic tasks required for operational safety.

In particular the connection between special features of a biomass heating system and his obligations as well as the warranty and guarantee terms must be explained. e.g. non-tested pellets and screw blockers, lack of cleaning or maintenance and stove malfunctions. Thorough instruction can prevent many complaints.

Stove functions

Explanation of the processes in the stove during ignition, normal operation, cleaning phase etc.

Control

Explain operator's possibilities to intervene, empty pellet container, room thermostat, GSM modem, functions and settings, program times if necessary. Operating instructions: Handover and reference to the content to the following points, is a document.

Warranty terms

Difference between warranty (statutory) and guarantee (voluntary), terms of guarantee, determination of wearing parts, reference to pellet quality to be used and the consequences of poor quality.

Cleaning instructions

Ash and dust occurs with a biomass heating unit. The fire trough is to be cleaned regularly with regular heating operation (in the case of pellet operation, the drilled air holes in particular must be free of residues). The ash drawer is to be emptied regularly. The flue gas pipes are to be cleaned once or twice in the heating season depending on stove type; by a specialist company is best.

Maintenance

Maintenance work after defined burn-off output is to be performed by specialist company, including thorough cleaning.

Combustion

All doors must close tightly to prevent intake of false air.

**Note**

Please contact your warranty partner for any warranty questions or claims. This is your dealer or installation company. No warranty claims can be accepted without proper putting into operation, proper operation according to the operating instructions and the supplements in this information sheet.

Protocol for putting into operation for RIKA pellet and combi stoves

Date: _____

Installation address	Dealer
Name: _____	Name: _____
Street: _____	Street: _____
City: _____	City: _____
Telephone: _____	Telephone: _____

Stove data

Stove type:	Casing undamaged
Serial number:	Operating instructions
Software version:	Warranty documents
Touchdisplay version:	Door opener

Electrical periphery

Connection socket earthed	GSM modem present
Room thermostat present	Function checked

Check of system components

Combustion chamber door seal checked	Ease of movement burnback flap checked (combi)
Ease of movement flue gas flap checked (combi)	

Exhaust line / chimney

Diameter	Connection leakproof
Bends	Chimney draught

Stove functions

Pellet container filled	Grid turns (360°) und keeps in heating position
Tested pellet quality according to Önorm/DIN plus/ENplus-A1	Ignition element glows
Electrical connections made	Screw motors run
Safety flaps tightened (combi)	Do pellets fall into the combustion chamber?
Induced draught blower runs	Ignition performed
Stove was switched off when handed over	

Operator instruction

Stove function	Warranty terms
Control	Cleaning
Operating instructions	Cleaning or maintenance interval

*work performed correctly according to order placed*_____
Technician:_____
Operator_____
Client

Company: _____

16. WARRANTY

These warranty conditions are only valid for the following countries: Austria, Germany and Switzerland. Separate conditions imposed by the importer apply for all other countries. In case of doubt as well as missing or incorrect translations, the German version is the only valid one.

For the purpose of timely damage limitation the claimant is required to file the warranty claim with the RIKA dealer in writing, submitting the invoice and stating the purchase date, model name, serial number and reason for complaint.

Warranty

5 years on the welded stove body. This exclusively applies to defects in materials and workmanship as well as free replacement. Labour and travel times are not included in the manufacturer's warranty.

Only original parts supplied by the manufacturer should be used. Loss of warranty on non-observance!

The precondition for the warranty is that the stove has been installed and commissioned properly according to the User and installation manuals valid at the time of purchase. Connection must be performed by a specialist for such stoves.

Any costs incurred by the manufacturer due to unjustified warranty claims are to be charged to the claimant.

Wear parts and parts affected by fire are excluded, such as glass, coating, surface coatings (e.g. handles, panels), seals, fire trough, grates, draught plates, deflector plates, combustion chamber liners (e.g. fireclay), ceramics, natural stone, thermo stone, ignition elements, sensors, combustion chamber sensors and temperature controller.

Also excluded from this warranty are all damages arising from non-observance of the manufacturer's operating instructions of the unit, or damage caused by overheating, use of nonapproved fuels, unauthorised tampering with the appliance or the flue gas pipe, electrical excess voltage, an incorrect, insufficient or excessive flue draught, condensation, non-performance or deficient maintenance and cleaning, nonobservance of the relevant and applicable building regulations, incorrect operation by the user or third parties, as well as any transport and handling damage.

This manufacturer's warranty does not affect the statutory warranty provisions.

02.12.2015



Technical and design changes, as well as typesetting and printing errors reserved

© 2017 | RIKA Innovative Ofentechnik GmbH

Mountain View Hearth Products
manuals.stove-parts-unlimited.com



RIKA Innovative Ofentechnik GmbH
4563 Micheldorf/Austria, Müllerviertel 20
Telefon: +43 7582 686-41, Fax-DW: 43
E-Mail: verkauf@rika.at

RIKA.AT

Z35486_EN_Memo | 1.12.2017