





















	Bezeichnung	Description	Artikelnr./ itemnr.	Bild/picture	
1	FR-Tür kpl.	combustion chamber door compl.	B15079		
2	FR-Türdichtung D12	combustion chamber door seal D12	100485		
3	FR-Türglas	combustion chamber door glass	Z30489		
	Verschlußbolzen	door handle	Z34102		
	Verschlußbolzen kpl.	door handle cpl.	B15774		
4	Oberer Temperaturbegrenzer	high limit switch	102659		
5	Zünderelement ab Snr. 192679	ignition element from serial number 192679	Z32147		
	Zünderelement bis Snr.192678	ignition element up to serial number 192678	Z28100		
	HP-Rohr ab Snr. 238050	ignition pipe from serial number 238050	B15650		
	HP-Rohr Snr. 192678-238049	ignition pipe serial number 192678-238049	B16151		
	HP-Rohr bis Snr. 192677	ignition pipe up to serial number 192677	B14893		
6	Förderschnecke kpl.	auger	B12301		
7	Zentrierplatte	centring plate	Z31674		
8	Motorplatte	motor plate	L00797		
9	Sechskantschraube	hexagonal bolt	100235		
10	Schneckenantriebsmotor	auger motor	B15732		
11	Luftsensor	air sensor	B15069		
20	Bedienboard	user board	B15092		
21	Hauptsicherung	main fuse	110696		
22	Hauptplatine	main board	B15090		

23	Tele-Control (optional)	Tele-Control (optional)	E13822		
30	Flügelmutter	wing nut	108306		
31	RG-Schachtputzdeckel	flue duct shaft cleaning lid	B15072		
	Putzdeckeldichtung	seal for cleaning lid	Z31636		
32	Zwischenboden	intermediate bottom	B14895		
33	unterer Putzdeckel kpl. Grau	bottom cleaning lid compl. grey	B15501		
	oberer Putzdeckel kpl. Grau	top cleaning lid compl. grey	B15077		
34	Rauchgasgebläsegehäuse	combustion fan housing	B16155		
35	Rauchgasgebläsemotor	combustion fan motor	111475		
36	Sechskantschraube	hexagonal screw	106989		
37	Untertemperaturschalter	low limit switch	111636		
	UTB-Dichtung	gasket for low limit switch	Z12388		
38	Rauchrohradapter 100 mm	smoke tube adapter 100 mm	Z18502		
	O-Ring D76/4,5	O-ring D76/4.5	108315		
39	FR-Türscharnier	combustion chamber door hinge	Z31671		
40	Behälterdeckel	hopper lid	B15073		
41	Rückwand	rear wall	Z33725		
42	SV hinten re. kpl.	right rear side cladding complete	B15076		
43	Rückwandabdeckung	rear wall cover	Z33724		
44	Netzkabel mit Schuko-Stecker	power cable with earthed plug	Z32219		
45	Ecksteher vorne re. kpl. metallic	right front side cover metallic	B15074		

	Ecksteher vorne re. kpl. alu	right front side cover alu	B15093		
46	Frontverkleidung unten	front cladding bottom depend on colour and material			
	Frontverkleidung unten Stahl Ellipse	front cladding bottom design ellipse	B15080		
	Frontverkleidung unten Stahl Quadrat	front cladding bottom design quadrat	B15089		
47	Frontverkleidung oben	front cladding top depend on colour and material			
	Frontverkleidung oben Stahl Ellipse	front cladding top design ellipse	Z32193		
	Frontverkleidung oben Stahl Quadrat	front cladding top design quadrat	Z32208		
48	Ecksteher vorne li. kpl. metallic	left front side cover metallic	B15075		
	Ecksteher vorne li. kpl. alu	left front side cover alu	B15094		
49	SV hinten li. kpl.	left rear side cladding compl.	Z32186		
50	Keramikdeckel mit Einlage	ceramic cover with inlay depend on colour			
	Deckeleinlage Ellipse	coverinlay ellipse	Z32194		
	Deckeleinlage Quadrat	coverinlay square	Z32210		
	FR-Auskleidung li/re	fire brick left/right	Z31471		
	FR-Auskleidung hinten	fire brick rear	Z31470		
	Türgriff	door handle	Z30493		
	Mulde ab Snr. 192678	burn pot from serial number 192678	Z32960		
	Mulde bis Snr. 192677	burn pot up to serial number 192677	Z32496		
	Konvektionenbläse (optional)	convection fan (optional)	E13823		
	Kabelbaum bestehend aus:	cable loop consisting of:			
	Netzkabel	power calbe	Z32219		
	Kabel Schneckenmotor	cable augermotor	Z32218		
	Kabel Zündung	cable ignition	Z32217		

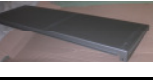
Kabel Bedienbord	cable userboard	Z32216		
Kabel Air Sensor	cable airsensor	Z32215		
Kabel UTB	cable low termerature switch	Z32214		
Kabel OTB	cable upper temperature switch	Z32213		
Kabel Erdung 300 mm	cable grounding 300mm	Z32212		
Kabel Erdung 600 mm	cable grounding 600mm	Z32211		

Mountain View Hearth Products
manuals.stove-parts-unlimited.com

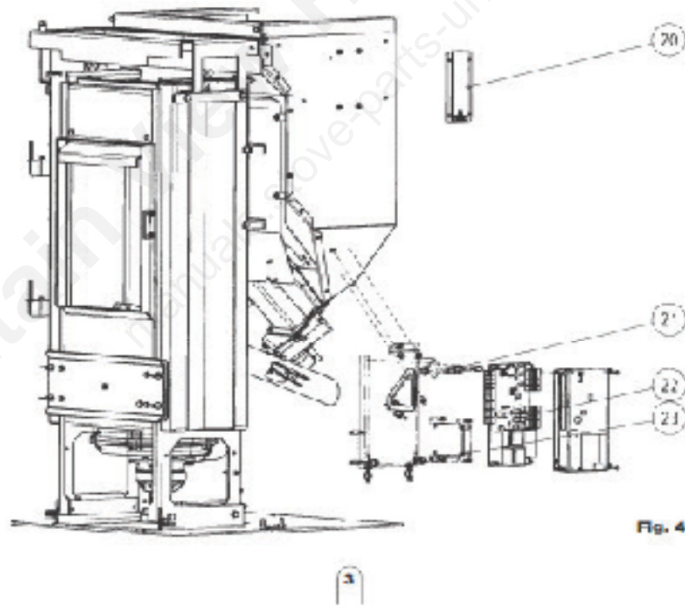
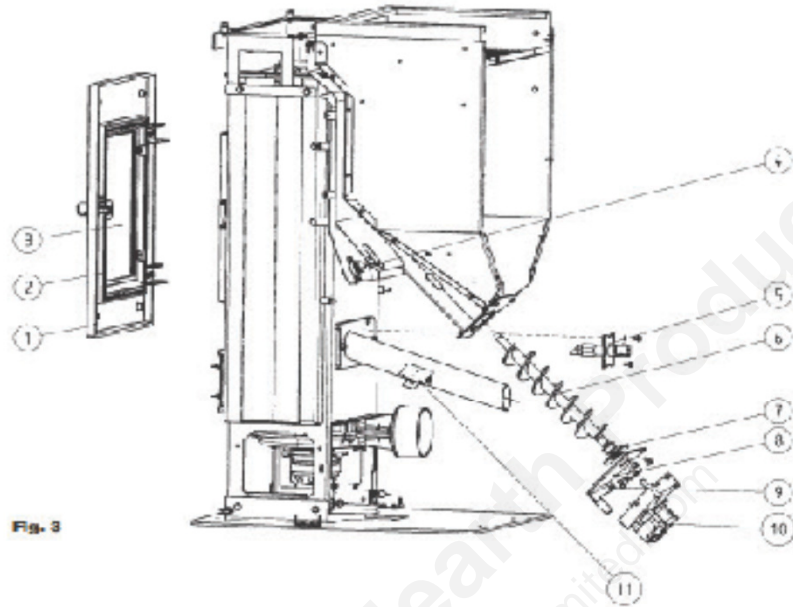

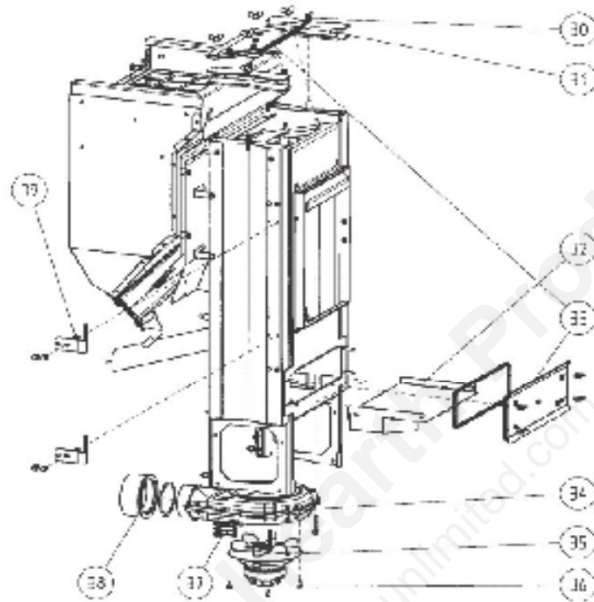

Fig. 3

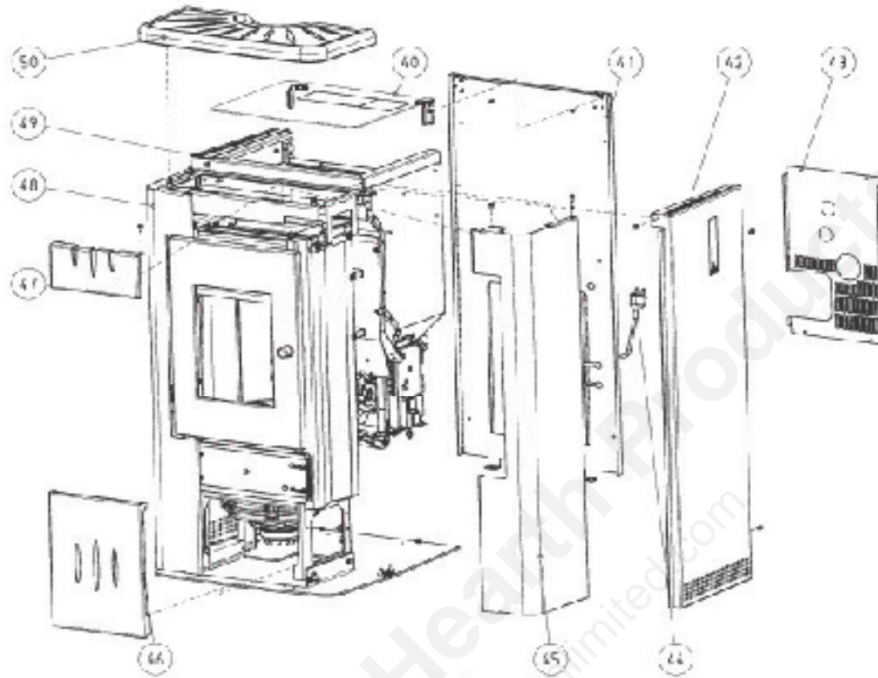

Fig. 6

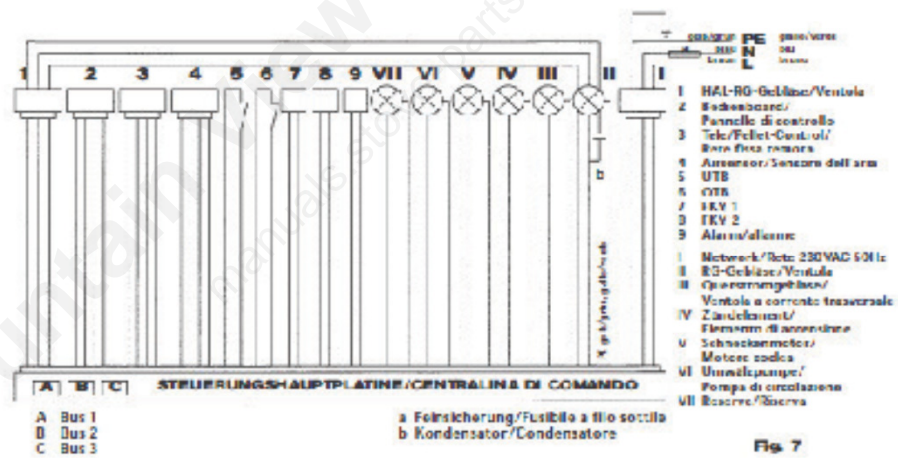

Fig. 7

5