



Acumen Model L

Fireplace Remote Control Operating Instructions For The Homeowner

The Acumen Model L Remote Control is designed for use with decorative gas fireplace and wall heaters using a Millivolt gas valve.

BEFORE YOU BEGIN:

Warning The pilot flame must be lit, with the gas control valve turned to "ON", for the remote to work correctly. Read all of the safety precautions in the owner's manual included with your fireplace before using this remote control. The thermostat is not intended for unattended use.

INSTALLING FRESH BATTERIES:

Note: It is not necessary to re-set your private code when installing fresh batteries.

The fireplace **MUST** be OFF before replacing transmitter batteries.

INSTALL BATTERIES INTO RECEIVER:

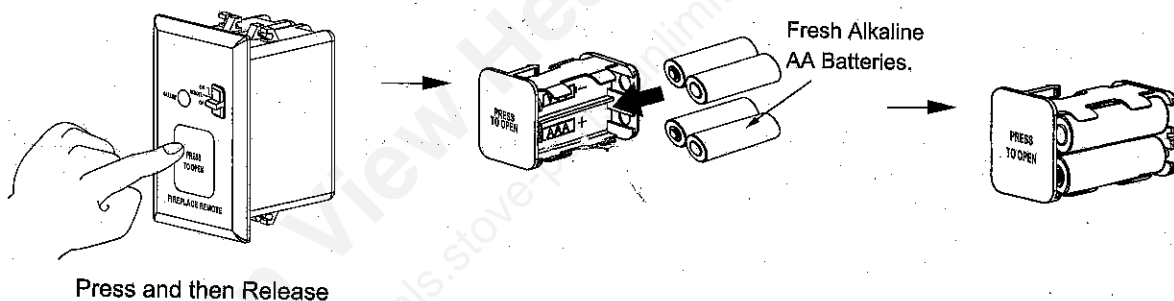

INSTALL BATTERIES INTO TRANSMITTER:

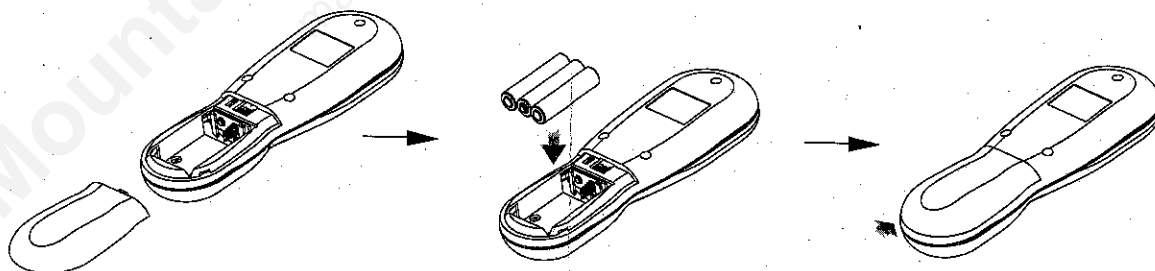

Change Batteries At Least Every 6 Months.

WARNING: THE REMOTE TRANSMITTER WILL AUTOMATICALLY SWITCH OFF THE FIREPLACE WHEN THE BATTERIES IN THE REMOTE TRANSMITTER ARE LOW.

RECEIVER OPERATION:

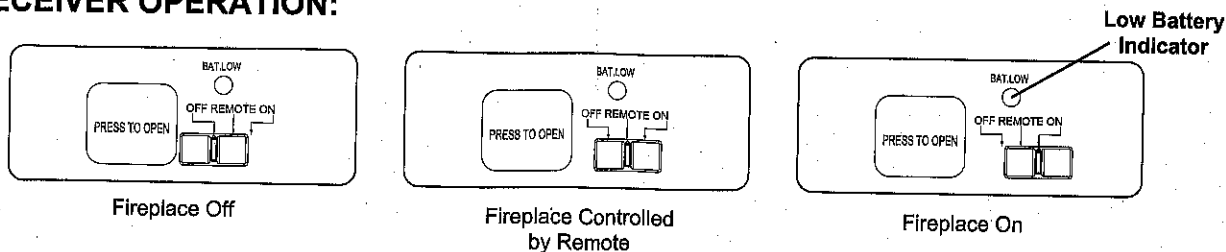

TRANSMITTER OPERATION:

WARNING: IT TAKES SOME TIME FOR THE RECEIVER TO RESPOND TO THE TRANSMITTER. DO NOT PRESS THE MANUAL OR AUTO ON/OFF BUTTONS MORE THAN ONCE WITH 2 SECONDS FOR CORRECT OPERATION.

Set Real Time Clock

1. Press and hold the "CLOCK" button for 2 seconds.
2. The hour display will flash. Use the "UP" and "DOWN" Buttons to set the hour.
3. Press the "CLOCK" button again.
4. The minute display will flash. Use the "UP" and "DOWN" Buttons to select the minute.
5. Press the "CLOCK" button again.
6. The °F or °C display will flash. Use the "UP" and "DOWN" buttons to select Fahrenheit or Celsius.
7. Press the "CLOCK" button again. Programming is complete.

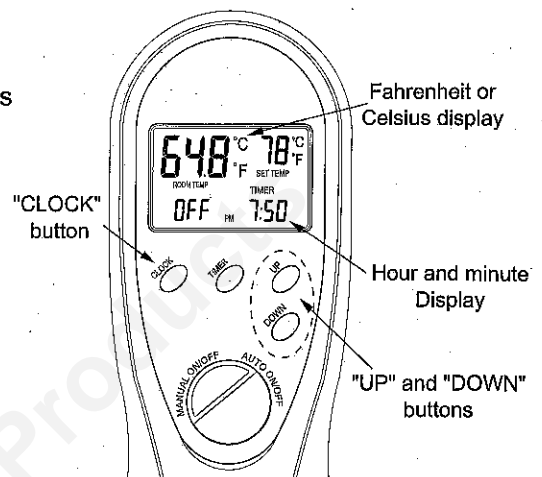

Auto Mode

Auto mode works like a thermostat, turning the heater on and off to meet the desired temperature.

CAUTION: THE REMOTE RECEIVER WILL AUTOMATICALLY TURN OFF THE FIREPLACE AFTER SIX HOURS OF UNINTERRUPTED OPERATION. PRESS AUTO ON/OFF BUTTON ON THE REMOTE TRANSMITTER TO RESET THE REMOTE CONTROL, THEN PRESS AUTO ON/OFF BUTTON AGAIN TO RESUME OPERATION.

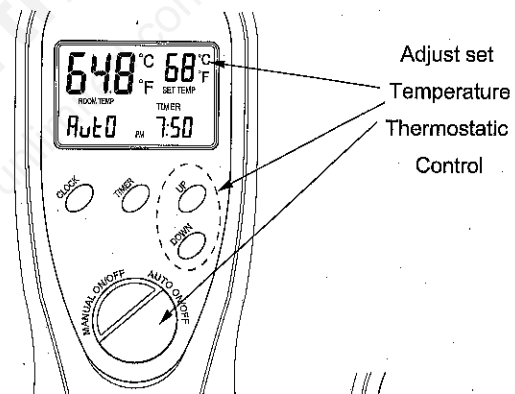

Manual Mode

1. Press the Manual On/Off button once to light the fireplace. Push the button again to turn it off.
2. In Manual mode the Remote Transmitter will not turn the fireplace off/on even if the room temperature exceeds the target temperature.

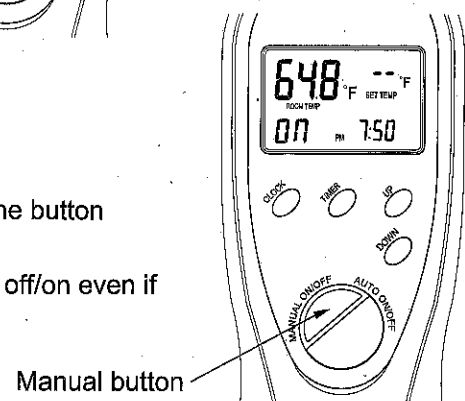

Timer Mode

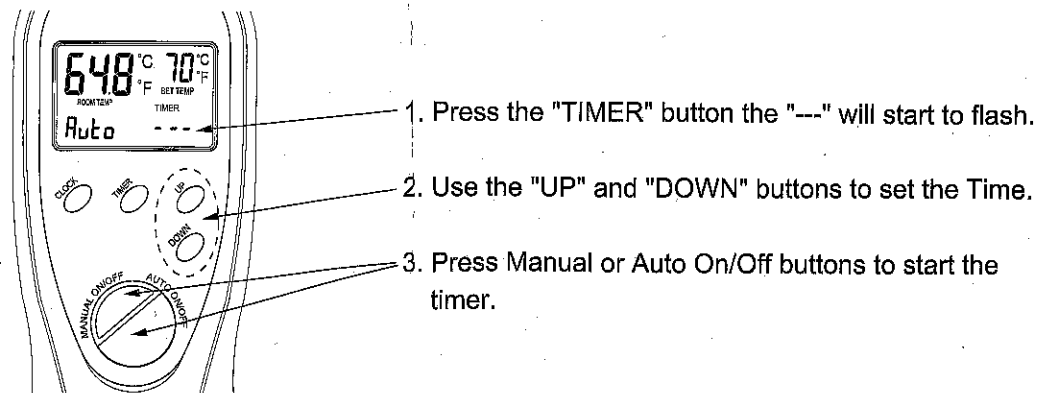

Child-Proof Feature

The Child-Proof switch disables the buttons on the front of the Remote. Thermostat and timer functions continue to operate.

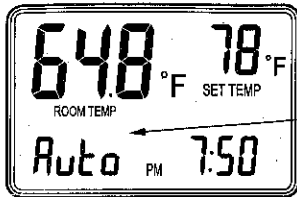

The words "Child-Proof" will disappear from the LCD.

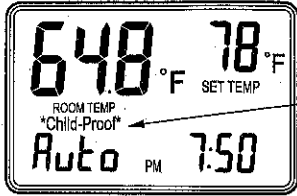

The words "Child-Proof" appear here when Child-Proof feature is turned on.

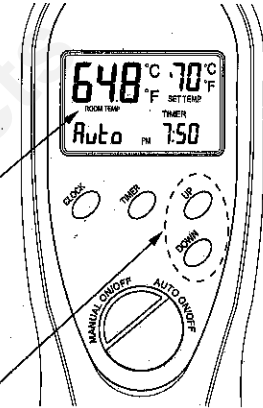
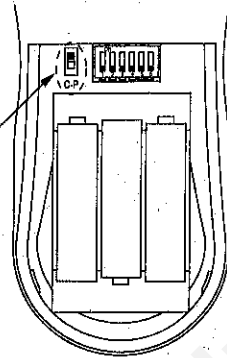
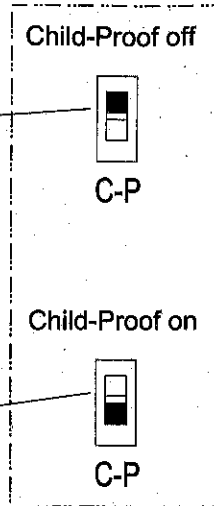

The "Child-Proof" will disappear from the LCD.

To unlock Child-Proof, press.
UP DOWN DOWN UP DOWN

SET PRIVATE CODE:

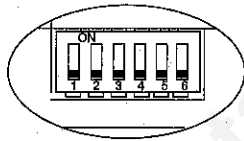

Select Code Position

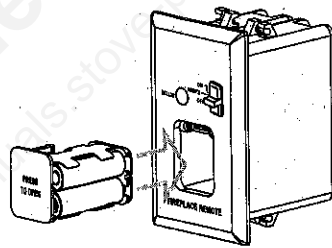

Install 4AA Batteries

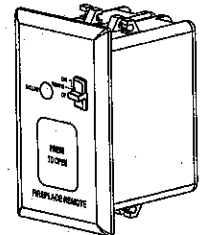

Switch off the Receiver

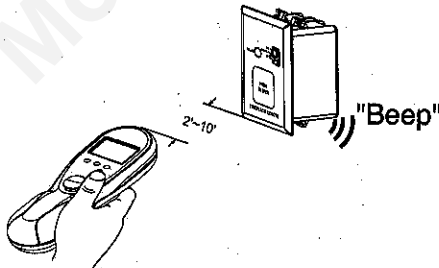

Press Any Button

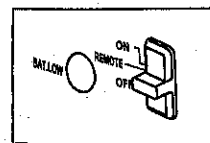

Switch Receiver to Remote

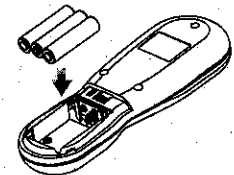

Install 3AAA Batteries

TRANSMITTER OPERATION:

WARNING: IT TAKES SOME TIME FOR THE RECEIVER TO RESPOND TO THE TRANSMITTER. DO NOT PRESS THE MANUAL OR AUTO ON/OFF BUTTONS MORE THAN ONCE WITH 2 SECONDS FOR CORRECT OPERATION.

Set Real Time Clock

1. Press and hold the "CLOCK" button for 2 seconds.
2. The hour display will flash. Use the "UP" and "DOWN" Buttons to set the hour.
3. Press the "CLOCK" button again.
4. The minute display will flash. Use the "UP" and "DOWN" Buttons to select the minute.
5. Press the "CLOCK" button again.
6. The °F or °C display will flash. Use the "UP" and "DOWN" buttons to select Fahrenheit or Celsius.
7. Press the "CLOCK" button again. Programming is complete.

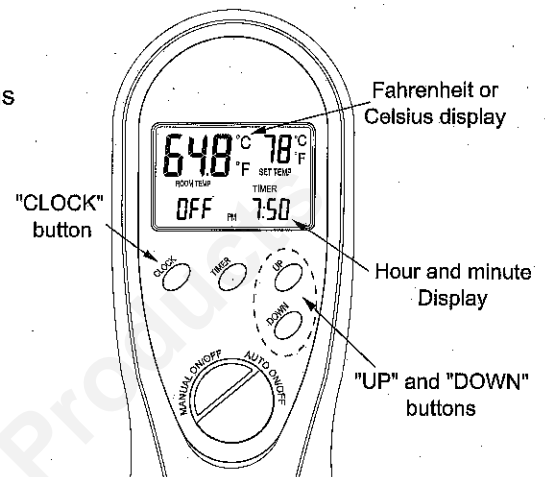

Auto Mode

Auto mode works like a thermostat, turning the heater on and off to meet the desired temperature.

CAUTION: THE REMOTE RECEIVER WILL AUTOMATICALLY TURN OFF THE FIREPLACE AFTER SIX HOURS OF UNINTERRUPTED OPERATION. PRESS AUTO ON/OFF BUTTON ON THE REMOTE TRANSMITTER TO RESET THE REMOTE CONTROL, THEN PRESS AUTO ON/OFF BUTTON AGAIN TO RESUME OPERATION.

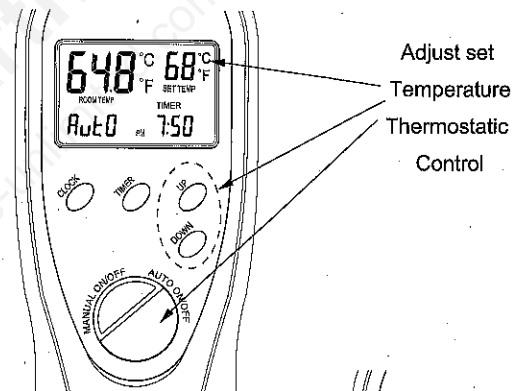

Manual Mode

1. Press the Manual On/Off button once to light the fireplace. Push the button again to turn it off.
2. In Manual mode the Remote Transmitter will not turn the fireplace off/on even if the room temperature exceeds the target temperature.

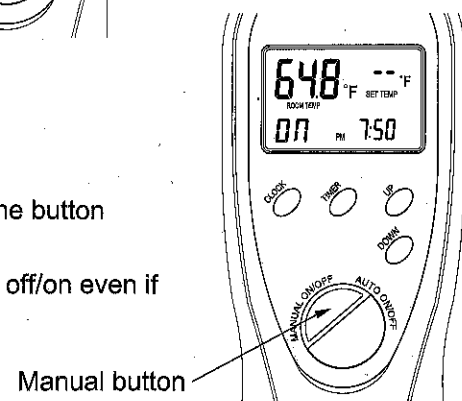

Timer Mode

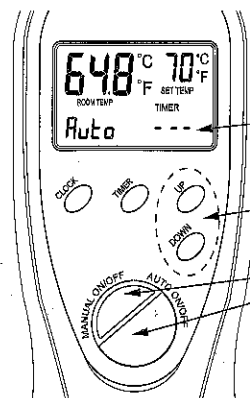

1. Press the "TIMER" button the "---" will start to flash.
2. Use the "UP" and "DOWN" buttons to set the Time.
3. Press Manual or Auto On/Off buttons to start the timer.

ACUMEN™

Acumen Model L

Remote Control Installation Instructions

INSTRUCTIONS TO THE HOMEOWNER.

The Remote Control is designed for use with decorative gas fireplace and wall heaters

and a six-button hand held transmitter, which turns the gas on/off or as a thermostat. The transmitter shows the clock, current room temperature, target temperature, timer setting, battery level and "Child-Proof".

The Remote Control is tested safe when installed in accordance with this installation manual. It is recommended that you read these instructions before starting installation and to follow these instructions carefully.

The Remote Control **MUST** be installed by a qualified service technician.

The Remote Control is carefully engineered and **MUST** be installed only as specified. If you modify the installation, it may possibly cause a fire hazard.

Never

operate the Remote Receiver is at the OFF position.

Connect the W, V, and TPTH terminals of the Millivolt valve. See *Figure 1*.

Receiver to a Wall Mount:

Mount the Receiver to the wall mount.

Secure the face blade to the Remote Receiver. See *Figure 2*.

Remote
Control

Installation of the
Receiver to a
Junction Box

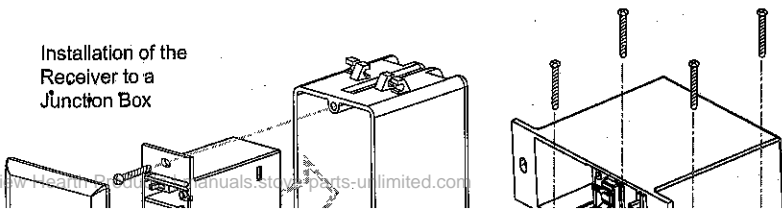

5. Put the switch cap to the slide switch.
6. Slide the battery compartment into the Remote Receiver. See *Figure 4*.
7. In order to prevent the Remote Receiver (fireplace installation only) from overheating, put a heat shield (option item) above the Remote Receiver. See *Figure 5*.

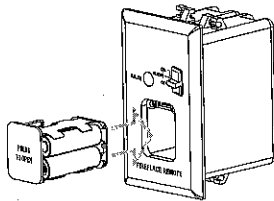

Figure 4

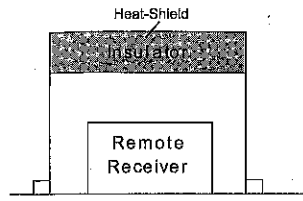

Figure 5

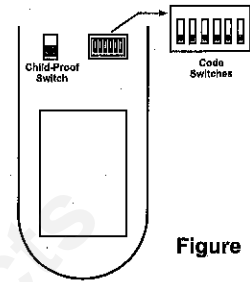

Figure 6

2.0 IMPORTANT SAFETY FEATURE:

You can set a private code into your system to prevent accidental operation by another transmitter nearby. See *Figure 6*.

2.1 Coding Instructions:

1. Remove the cover on the back of the Remote Transmitter to expose the code switches. Slide the code switches to your choice of ON or OFF positions. **FACTORY SETTING IS ALL "OFF"**.
2. Make sure the slide switch on the Remote Receiver is at OFF position.
3. Keep the Remote Transmitter and the Remote Receiver within 2-10 feet.
4. Slide the slide switch on the Remote Receiver to REMOTE position.
5. Install fresh AAA alkaline batteries into the Remote Transmitter.
6. Press any button on the Remote Transmitter, the Remote Receiver will produce a 'beep' sound when it receives the code from the Remote Transmitter.
7. If you do not hear a 'beep' sound from the Remote Receiver, remove the batteries from the Remote Transmitter and slide the slide switch on the remote receiver to OFF position, Wait for 1 minute, and repeat step 2 to 6.
8. Replace the cover of the Remote Transmitter and the Receiver. The system is now ready to operate.

FCC Requirements

Warning : Changes or modifications to this unit not expressly approved by the party responsible for compliance could void the user authority to operate the equipment. This equipment has been tested and found to comply with the limits for a Class B digital device, pursuant to Part 15 to the FCC Rules. These limits are designed to provide reasonable protection against harmful interference in a residential installation. This equipment generates, uses, and can radiate radio frequency energy and, if not installed and used in accordance with the instructions, may cause harmful interference to radio communications. However, there is no guarantee that interference will not occur in a particular installation. If this equipment does cause harmful interference to radio or television reception, which can be determined by turning the equipment off and on, the user is encouraged to try to correct the interference by one or more of the following measures:

- Reorient or relocate the receiver antenna.
- Increase the separation between the equipment and receiver.
- Connect the equipment into an outlet on a circuit different from that to which the receiver is connected.
- Consult the dealer or an experienced radio TV technician for help.

Canadian Equipment Requirements

This digital apparatus does not exceed the (class A/Class B)* limits for radio noise emissions from digital apparatus set out in the Radio Interference Regulations of the Canadian Department of Communications. Le présent appareil numérique n'émet pas de bruits radioélectriques dépassant les limites applicables aux appareils numériques (de la class A/de la class B)* prescrites dans le Règlement sur le brouillage radioélectrique édicté par le ministère des Communications du Canada.

This device complies with RSS-210 of Industry and Science Canada. Operation is subject to the following two conditions: (1) this device may not cause interference, and (2) this device must accept any interference, including interference that may cause undesired operation of the device.

All wiring should be done by a qualified electrician and shall be in compliance with local codes and with the National Electric Code ANSI/NFPA No. 70-current (In the United States), or with the current CSA C22.1 Canadian Electric Code (In Canada).