

AMERICAN ENERGY SYSTEMS INC.

INSTALLATION, OPERATION AND MAINTENANCE MANUAL

COUNTRY FLAME SERIES LITTLE RASCAL Pellet Fuel Stove FREESTANDING LEG, MODEL LR-01

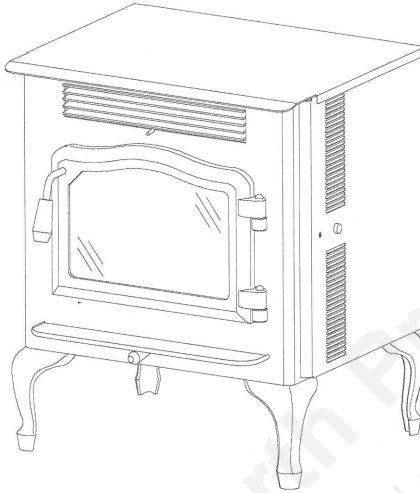

FOR YOUR SAFETY

Do not store or use gasoline or other flammables (vapor or liquids) in or around the vicinity of this appliance. Installation and repair must be performed by a qualified service agency.

Always check with local jurisdiction or code agency before installing this product. Local jurisdiction may be requiring a permit prior to installation.

This appliance requires that you only burn premium quality wood pellet fuel

It is required to install this product using a 3" diameter or larger fresh air supply. It is recommended that venting be installed with a 3 to 5 foot rise whenever possible.

WARNING: If the directions in this manual are not followed exactly, a fire may result causing property damage, personal injury or loss of life. Maintenance and cleaning are very important. Please read the maintenance section of this manual very carefully.

Technical support is provided by your local installation service provider. If you should require factory technical support it is available FREE by going to www.magnumheat.com and selecting the Technical Forum or by emailing technical@magnumheat.com.

TESTED BY: WARNOCK HERSEY – MOBILE HOME APPROVED

USA & CANADA TEST: ASTM E1509-04, UL 1482, ULC S627, ULC/ORD C1482 (and ULC S628 if listed for fireplace insert Installation in Canada) Oregon Administrative Rules 814-23-900 thru 909



©2011

Version 1.0.1c

01/2012

Mountain View Hearth Products
manuals.stove-parts-unlimited.com

**LITTLE RASCAL
MODEL LR-01 PELLET FUEL STOVE
TABLE OF CONTENTS**

Introduction	Page 3
Safety Notes	Page 4-6
Specifications	Page 6
Operating Instructions	Page 7-15
Description	Page 8
Pre-Operation Notes	Page 10-15
Lighting Procedure/board operation	Page 15-17
Board operation expanded	Page 17
Wiring Diagram	Page 18
Maintenance	Page 19-21
Installation Instructions	
Precautions	Page 22
Free Standing Unit	
Positioning	Page 22
Venting	Page 23-25
Details	Page 25-26
Leg Installation	Page 27-28
Insert Unit	
Positioning	Page 29
Venting	Page 30
Details	Page 30-31
Mobile Home Venting Standards	Page 32
Plates & Tags	Page 33
Warranty	Page 34-35

**LOOK AT THE LABEL ON THE BACK OF YOUR UNIT TO FIND THE SERIAL NUMBER.
WRITE IT HERE _____ IMMEDIATELY.**

Failure to do so will make servicing and maintenance questions difficult to answer and could result in needless inconvenience in the future. You will need the serial number of your unit if it requires servicing.

Mountain View Hearth Products
manuals.stove-parts-unlimited.com

INTRODUCTION

Congratulations on your purchase of a American Energy System Inc. (AES) solid fuel Wood Pellet Appliance. Your Pellet Stove was designed to provide you with durable, reliable performance and ease of operation.

The Country Flame LR-01 has been painstakingly designed with your comfort in mind. On those cool evenings when you'd like a little extra heat in the room, but you don't want to turn on the furnace, you'll enjoy the thermal efficiency of the LR-01. Whether you use your unit to heat a single room or several rooms, you'll appreciate the speed with which your unit can be lit and brought up to temperature.

You'll feel that you've slipped into the homey comforting glow of yesterday as you warm yourself in front of your new heater, with all the comforts of a good, solid wood burning stove, but without the bulk and mess of a conventional heater. While others have to trudge outside to chop wood and gather kindling, you'll be warming yourself by the fire, fueled by easy to load pelletized solid fuel. On cold winter nights, your LR-01 will become a true friend and you'll wonder how you ever got along without it.

Features:

- *Clean Pelletized Solid Fuel System
- *HOT 15 Tube Exchanger Design
- *Industry Proven Auger System
- *Solid Brass Door & Trim Available
- *Integrated Control System
- *Freestanding Queen Ann Leg Options

Thank you from all the employees of American Energy Systems Inc.

This is a comprehensive manual – to avoid confusion when installing your stove:

1. Read and familiarize yourself with the Entire Manual and Safety Notes.
2. Follow the Installation Instructions, Precautions, Positioning, Venting, and Details.
3. Follow the Operating Instructions, Lighting, Shutdown and First Time Operation.

Mountain View Hearth Products
manuals.stove-parts-unlimited.com

SAFETY NOTES

FOR SAFE OPERATION – THIS MANUAL MUST BE USED FOR INSTALLATION OF STOVE UNIT AND RETAINED BY THE OWNER FOR OPERATION AND MAINTENANCE INFORMATION.

PLEASE READ ALL OF THIS MANUAL AND SAFETY NOTES. The Country Flame LR-01 Pellet Stove is different from conventional wood burning appliances. It is very important that you read and understand all of the instructions before installing and using your Pellet Stove. Follow the procedures and maintenance instructions outlined in this manual exactly. Failure to follow instructions may result in property damage, bodily injury, or even death. It is recommended that you have your unit installed by your authorized Country Flame dealer or at least have them inspect your installation.

1. **Because Country Flame has no control over the installation of your unit, Country Flame grants no warranty, implied or written, for the installation or maintenance of your unit and assumes no responsibility for any consequential damage.**
2. **Fill out the warranty card included with your unit.** Send the return portion of the warranty card to the factory. Please retain the other portion with this manual.
3. This heater will not operate using natural draft or without a power source for the blowers and fuel feeding system.
4. Never attempt to repair any part of the unit unless following instructions in this manual. Installation and repair should be done by a qualified service technician. Any parts removed for servicing must be replaced prior to operation.
5. Any modifications to the unit, unless authorized by American Energy Systems Inc, could be dangerous and void the warranty of the unit.
6. This unit must be connected to a grounded standard 110-volt 60hz electrical outlet. **NEVER** use an adapter cord or cut or remove the grounding prong from the power cord plug.
7. **ALWAYS** wait until the unit is cooled and disconnect power before performing any maintenance or cleaning procedures.
8. **NEVER** place combustible objects on or near your heater.
9. **NEVER** allow children near heater during operation, and do not allow anyone to operate the unit who is unfamiliar with these instructions.
10. Children and adults should be alerted to the hazards of high surface temperature and should stay away to avoid burns or clothing ignition.
11. Young children should be carefully supervised when they are in the same room as the heater.

Mountain View Hearth Products
manuals.stove-parts-unlimited.com

12. **NEVER** connect this unit to a chimney flue serving another appliance.
13. **ALWAYS** follow the lighting instructions in this manual; short cuts of any kind can be dangerous.
14. Check your local building codes and consult your insurance company before installing your unit.
15. Due to high temperatures, the pellet stove should be located out of traffic and away from furniture and draperies.
16. Clothing or other flammable material should not be placed on or near the room heater.
17. When disposing of ash accumulations from your unit, always place them in a metal container with a tight fitting lid. The closed container must be placed on a non-combustible surface well away from all combustible materials, pending final disposal. The ashes should be retained in the closed container until all cinders have thoroughly cooled.
18. Any safety screen or guard removed for servicing a room heater must be replaced prior to operating the room heater.
19. Your unit is designed and approved for burning of Premium Wood Pellet fuel, which meets or exceeds APFI standards only. Burning of solid fuel in other than pellet form is not permitted. Failure to comply with this restriction will void all warranties and the safety listing of the unit. Poor quality fuel will directly (*and adversely*) affect efficiency and cleanliness of your unit's operation. Your Country Flame dealer can help you make the proper fuel choice for your area.
20. **NEVER** use gasoline, gasoline-type lantern fuel, kerosene, charcoal lighter fluid or similar liquids to start or "freshen up" fire in this heater. Do not store or use gasoline or other flammable vapors and liquids in the vicinity of this or any other appliance.
21. **INSTALL a smoke detector/carbon monoxide detector within the proximity of your pellet stove.**
22. **NEVER** put foreign objects in the hopper. **NEVER** burn trash or unapproved material in your LR-01.
23. **NEVER** block free airflow through open vents or fresh air intake.
24. The exhaust system should be checked twice a year (minimum) for any buildup of soot or creosote.
25. This unit's exhaust system works with a negative combustion chamber pressure and a low positive flue pipe pressure. It is very important that the exhaust system be properly installed and air tight. The flue pipe joints should be sealed. Use high temperature RTV (500⁰F) (260⁰C) silicone sealant or aluminum flue tape and secured each joint with at least (3) sheet metal screws. Improperly installed stove flues are the major cause of home fires. **Always provide a fresh air direct connect to the appliance.**
26. When installed in a mobile home, a pellet stove must be grounded to the steel chassis of the mobile home and bolted to the floor in compliance with and according to H.U.D. requirements.
27. **SOOT AND FLYASH:** The products of combustion will contain small particles of flyash. The flyash will collect in the exhaust venting system and restrict the flow of the flue gases. Incomplete

Mountain View Hearth Products
manuals.stove-parts-unlimited.com

combustion, such as occurs during start-up, shut down, or incorrect operation of the room heater will lead to some soot formation which will collect in the exhaust venting system. The exhaust venting system should be inspected at least once every year to determine if cleaning is necessary.

SPECIFICATIONS

FUEL TYPE:	A.P.F.I. residential fuel: Premium quality fuel only	
	Heat Content: 8200 BTU/lb. min.	
	Bulk Density: 40 lb. /cubic ft. min.	
	Moisture Content: 8% max	
	Ash Content: 1% max	
	Size: ¼" to 5/16" diameter	
	1." long max	
	Fines: 1% max through 1/8 th screen	
HOPPER SIZE:	55pounds Hopper Capacity	
FLUE SIZE:	3" or 4"	
TYPE:	PL double wall vent with stainless steel inner liner	
AIR INLET:	3" diameter (non-combustible) pipe (recommend double walled B-vent for fresh air only)	
AUGER TYPE:	Tumac 2 ¼ Auger Pellet Feed System	
CONTROLS:	Integrated Feed Rate/Blower Speed Controls	
ELECTRICAL:	120 Volts, 2.4 Amp, 60 Hz (always install an approved surge protector)	
MEASUREMENTS:	UNIT BODY HEIGHT	22 ¾"
	HEIGHT ON PEDESTAL	32 ¾"
	HEIGHT ON LEGS	31 1/4"
	UNIT WIDTH	26"
	UNIT DEPTH	19 3/4"
	SHROUD HEIGHT	29 7/8"
	SHROUD WIDTH	45 7/8"
CLEARANCES:	SIDES	1"
	BACK	2"
	TOP TO COMBUSTIBLE	3"
	TOP TO CEILING	3"

*Combustible Flooring must be covered with non-combustible material extending 6" (150 mm) from front of unit and 8" (205 mm) from unit on each side. The floor protection on the sides of the stove only has to extend to the vertical sidewall(s) if the clearances are less than 8".

Mountain View Hearth Products
manuals.stove-parts-unlimited.com

DESCRIPTION

The LR-01 Wood Pellet Stove is designed to sit on legs as a freestanding unit. The basic stove unit measures 22 3/4" high by 26" wide and 19 3/4" deep. Centered above the firebox glass front door is a vent through which room convection air is passed.

The left side of the Little Rascal has a control panel called the control board. The control board includes 5 heat settings, an ON/OFF switch and lights to indicate the operational state of the board. The control board monitors and controls all functions of stove operation. Fine tuning the air flow is controlled by the operator with a damper. The damper is manually set to obtain optimum burn based on heat setting and local site conditions. Typically, the air setting will be 1/2 to 2/3 open all the time.

On the back of the Little Rascal stove is located a 3" tube for installation of outlet exhaust vent pipe. Also located on the back of the stove is a place to install a 3" inlet air tube to bring fresh air in from outside the house. DO NOT INSTALL too long a length of fresh air pipe at 3". Length and size of fresh air pipe will be determined by local site specific conditions. Typically do not have over 2 elbows and over 10 feet go to 4" diameter. The top of the unit lifts up for easy loading of fuel.

1. The Country Flame LR-01 is remarkably simple and safe in its operation. From a relatively small firebox over 40,000 BTU's per hour can be produced.
2. The fuel (APFI approved) is loaded into the hopper. After the fire has been lit (see lighting instructions) an angled drive auger delivers fuel, a few pellets at a time, into the firepot at a controlled rate. The combustion blower delivers directed air input, creating a vigorous, efficient burn. The hot exhaust gases are drawn through a 14-tube heat exchanger, which extracts heat from the gases as they are discharged to the exhaust pipe.
3. A second blower circulates room air through the heat exchanger, pushing warm air into the room from the tubes located just above the door. The room air blower is intended to run continuously and can be easily controlled to maintain a uniform temperature.
4. The Pellet Stove will deliver a constant amount of heat, which can be varied by setting the fuel control knob. Besides initial lighting of the unit, the only regular attention needed will be to fill the 55pounds hopper with fuel; inspection of the firepot for "clinkering" (see operating instructions) and removal of ash buildup as required. Typical would be once a day or twice if fuel is lower quality.

AIR DAMPER ADJUSTMENTS

Each LR-01 is shipped with an air damper adjustment. The air damper control is located on the front of the pellet stove below the hearth lip located directly centered on the front door. As site specific operating conditions require, such as fuel, altitude, and customer usage preferences require, there will be a requirement to adjust the air damper

Mountain View Hearth Products
manuals.stove-parts-unlimited.com

for more or less combustion air to the unit. To vary the air, the air damper control is slid in (less air) and out (more air.)

1. Conditions that warrant more combustion air (2/3 to full open) are:
 - Hardwood pellets
 - Higher altitudes
 - Increased heat settings (3- 5)
2. Conditions that warrant less air (1/3 to 1/2):
 - Softwood pellets
 - Low altitudes
 - Lower heat settings (2-3)
3. Conditions that warrant even less air:
 - Softwood pellets
 - Low altitudes
 - Lower heat settings (1-2)

Things to watch for:

TOO LITTLE AIR

- Extremely lazy flame
- Extremely black and dirty conditions in firebox
- When extended burn on High Settings, too many pellets in firepot

TOO MUCH AIR

- Flame is aggressive but as time progresses, the flame is barely visible
- Fire disappears in burn pot, shown below, or goes out on low settings

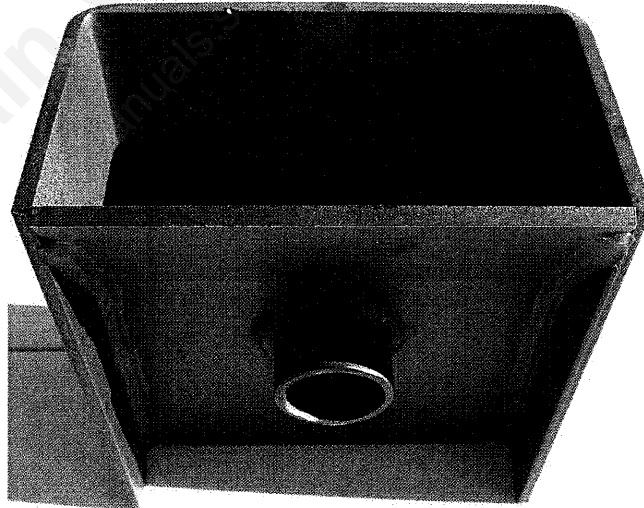

Note: Once you have determined the correct air usage for the heat setting and local site conditions, the air damper control will not need to be adjusted as often. Remember, any change in site specific conditions will require an adjustment of the air damper.

Don't be too quick to change air settings. Let the unit burn for an hour or two to balance the fuel load.

Mountain View Hearth Products
manuals.stove-parts-unlimited.com

PRE-OPERATION NOTES

1. Thoroughly read and understand this manual. Pay particular attention to the maintenance and safety sections of this manual. Failure to inspect the stove and understand these instructions may cause unsatisfactory performance.
2. Check to see that the intake and exhaust vents are properly tight and correctly installed.
3. Remove protective materials such as plastic coverings, plastic bags, and other material shipped with the stove.
4. Insure that the stove is connected to a code approved 120 volt AC power source. Ensure that the power provided is stable and not varying. If necessary, include a cost-effective UPS (power source) between the stove and house power to minimize any problems with the stove. **A power surge protector is required for warranty.**
5. Open the hopper lid and inspect the hopper before filling with fuel. ENSURE no foreign objects are left in hopper before loading it with approved pellet fuel.
6. The first time the Little Rascal pellet stove is fired up, an odor or smoke may emanate from the pellet stove. This is normal and should not last very long. Once the unit is "broken in" (after that first firing) no future odors or smoke should appear. This may take a few hours, be sure to burn the unit on low settings.
7. Fuel should conform to A.P.F.I. standards (see page 7). **This unit requires Premium quality fuel only.**
8. Please note: Premium quality labeling does not always mean that the fuel is good. Check to make sure that the fuel is not old (left over from previous season) and that the fuel has been kept in climate controlled warehousing. Wet, damp weather will cause the fuel to soften and crumple in the bag and in the unit. If you find this, return the fuel to where you purchased it and request good fuel.

Mountain View Hearth Products
manuals.stove-parts-unlimited.com

IGNITION/START-UP PROCEDURE

American Energy Systems Inc. (AES) introduced its exclusive control board technology in 2011. This control board technology was introduced across all lines of Magnum and Country Flame pellet and corn stove products. AES continues to demonstrate leadership in bringing new products to market. AES developed its own control board technology in order to bring reliable, supportable, and sustainable biomass-fueled products to market throughout the 21st Century.

AES's control board design goal was simple:

PROVIDE THE LATEST CONTROL METHODOLOGY TO ENSURE MAXIMUM BURN EFFICIENCY WHILE AUTOMATICALLY CONTROLLING AS MANY ENVIRONMENTAL AND SYSTEM VARIABLES IN ORDER TO ENSURE CUSTOMER SATISFACTION WITH THE PRODUCT WHILE GAINING CONFIDENCE IN THE PRODUCTS ABILITY TO OPERATE WITH LIMITED CONSUMER EFFORT.

AES's control board technology is defined as an "open system." This means that AES will seek to provide the most advanced controls methodology in the coming years while maintaining the look and feel that dealers and customers come to know and expect. This means that a purchase of today's Magnum or Country Flame product allows a customer to upgrade to newer and more advanced technology, as it becomes available while minimizing cost. AES is committed to ensuring its customer base will remain a life long family member once the initial purchase of product is complete. AES's goal is to ensure a service technician can diagnose and repair any product problem in less than 30 minutes from arrival to departure of a customer's home. The service technician will have to demonstrate an understanding of control methodology, sensors, basic electric theory, and system operation in order to assist in achieving these goals.

The following block diagram demonstrates the basic theory behind today's control board technology:

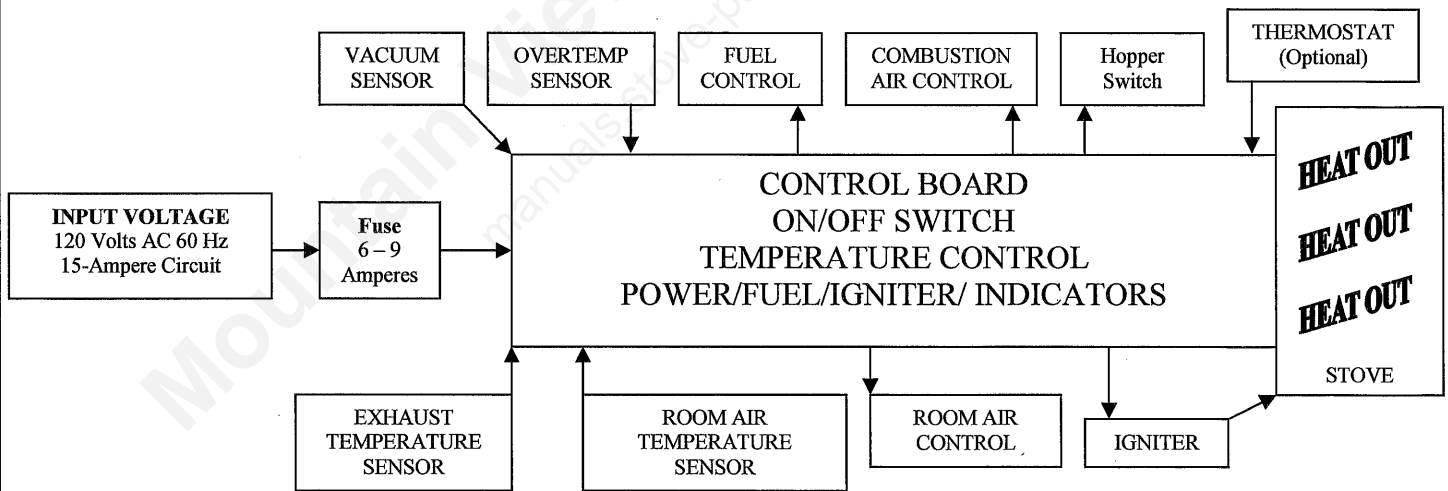

The basic block diagram shows the input and output components to the control board. The failure of any of these items to work properly will cause a malfunction in the system. Further information on each function is provided in the tables below.

Mountain View Hearth Products
manuals.stove-parts-unlimited.com

Input Voltage	Alternating Current (AC) Input provided by the local power company. This source of energy must provide a 120 Volt input signal with a frequency of 60 Hertz and a maximum branch current capacity of 15 Amperes. If other devices are connected to the branch, interference or over current may cause circuit breaker to trip.
Fuse (fast acting)	The AC fuse should be rated between 6 and 9 amperes.
Vacuum Sensor	Ensures that no blockage of the combustion input or combustion exhaust air occurs. If the vacuum sensor does not operate properly, the Control Board will not allow the stove to operate.
Exhaust Temperature Sensor	Presently, this sensor is a snap disk operating at 110° F +/- 20° F. This sensor ensures proper exhaust temperature has been reached and that a fire is present in the burn pot before the control system begins the burn cycle.
Overtemp Sensor	Presently, this sensor is a snap disk operating at 250° F +/- 20° F. The purpose of this sensor is to shut the entire system down in the event the firebox causes an overheat condition.
Fuel Control	The fuel control is a signal provided from the Control Board to the Auger Feed Motor. The Control Board controls the amount of time that the Auger Feed Motor is on and thereby controls the amount of fuel fed to the fire pot.
Room Air Control	The room air control is a signal provided from the Control Board to the Room Air Fan. The Control Board controls the phase angle and thereby the amount and time an AC voltage is applied to the Room Air Fan. This signal controls the speed of the room air passing over the heat exchanger tubes and the amount of heat delivered to the living space.
Combustion Air Control	The combustion air control is a signal provided from the Control Board to the Combustion Fan. The Control Board controls the phase angle and thereby the amount and time an AC voltage is applied to the Combustion Air Fan. This signal controls the speed of the combustion air passing through the burn pot for the different heat settings
Stir Rod	An AC device used to create turbulence in the burn pot. The stir rod reduces the potential of a clinker thereby ensuring more efficient combustion process. The operator must remove and clean the stir rod from time to time. Be careful not to damage or break the stir rod.
Thermostat (optional)	A thermostat input is provided on the back of each Country Flame product. The Control Board has individual personality modules that allow for stand-alone, semi automatic, or fully automatic thermostat operation.

Mountain View Hearth Products
manuals.stove-parts-unlimited.com

FIGURE 5 displays the Country Flame Control Board front panel. Each function of the Control Board is identified. (NPS-1005-N-7 control center, 2011 and newer models)

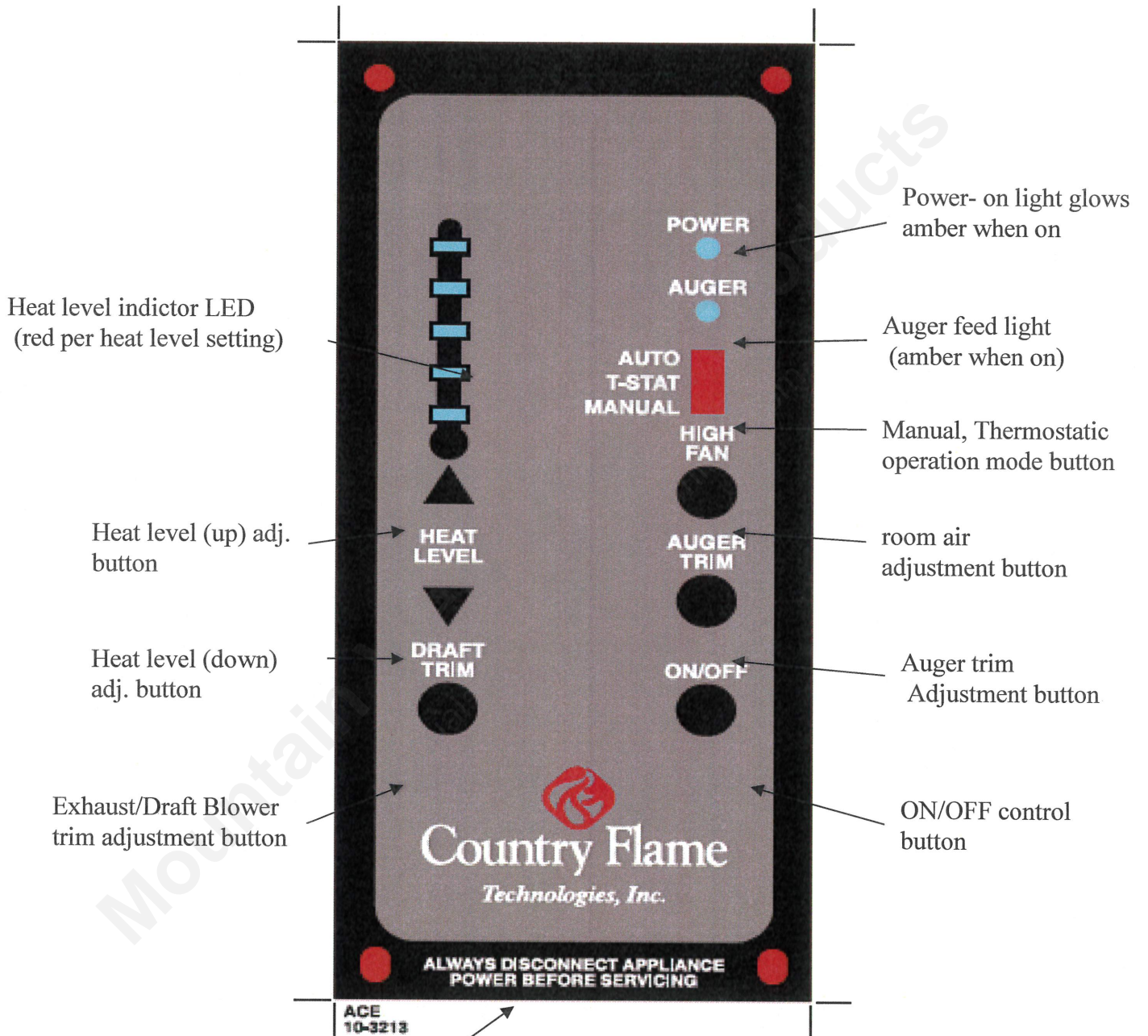

Please NOTE:

Mountain View Hearth Products
manuals.stove-parts-unlimited.com

OPERATING INSTRUCTIONS

(Using self igniter systems, if auto ignition system (optional) has been installed)

NOTE: Before the stove is started, the firepot must be checked for debris and clear air holes. Some fuels will cause the firepot to build up more frequently making it necessary to stir and clean the firepot more often. Do not allow ash to build up underneath the firepot area or in the ash pan as it will block off the air flow to the firepot.

Your control panel has three (3) separate modes of operation (switch located on top of board). The MANUAL setting allows the operator to choose heat level setting changes without a thermostat. The T-STAT setting allows the operator to set the highest heat level setting desired and when the thermostat is satisfied, the unit will automatically go to the low heat level setting. The AUTO setting allows the unit to shut completely off when the thermostat is satisfied and re-start when the thermostat calls for heat. The AUTO setting can only be used with **wood pellets**

Before lighting your Country Flame for the first time make sure that all items are out of the hopper and firebox area. Note: If using a wall thermostat, make sure that the thermostat is turned up above room temperature. The unit will operate on low fire if the thermostat is turned down.

- ✓ Load the hopper with fuel (Wood Pellets only on LR-01).
- ✓ Close the door
- ✓ Push the "On/Off" button.
- ✓ Turn the air intake butterfly damper to approximately ¼ inch open. (More or less as needed.)

NOTE: Priming the auger is required when the unit is new or when the hopper has completely run out of fuel. This can be done approximately 1 minute after pushing the on/off start button. Press and hold the "auger" button until fuel begins to drop into the firepot. When fuel begins to drop regularly, release auger button, the auger is primed.

NOTE: The viewing door, ash pan door and hopper door must be closed and/or latched during operation or vacuum will not be established. If vacuum can not be established the stove will shut down and the #2 heat level setting light will blink. The ON/OFF button must be held for app. 6 seconds to reset.

The unit starts automatically on a pre-set heat level setting. After the unit has been turned on, and the 1 minute diagnostics has run, you may select a desired heat level. However, the heat level feed rate will not change until the unit has completed the 15 minute startup sequence. It is recommended to burn the unit on the number #2 or #3 heat level setting for the first 30-45 minutes.

If the fire temperature has not reached proper operating temperature within the minimum cycle time (15 min.) the auger will stop feeding, the stove will shut down and the #3 heat level setting light will blink. You will need to press and hold the ON/OFF button for 6 seconds to start the cycle over again. If the system is set on auto start it will attempt two startups on its own.

The draft and room air blower speed varies with each feed rate. The "Draft Trim" button will override the variable fan function +/- 5 volts on all heat levels. To override, press and hold the

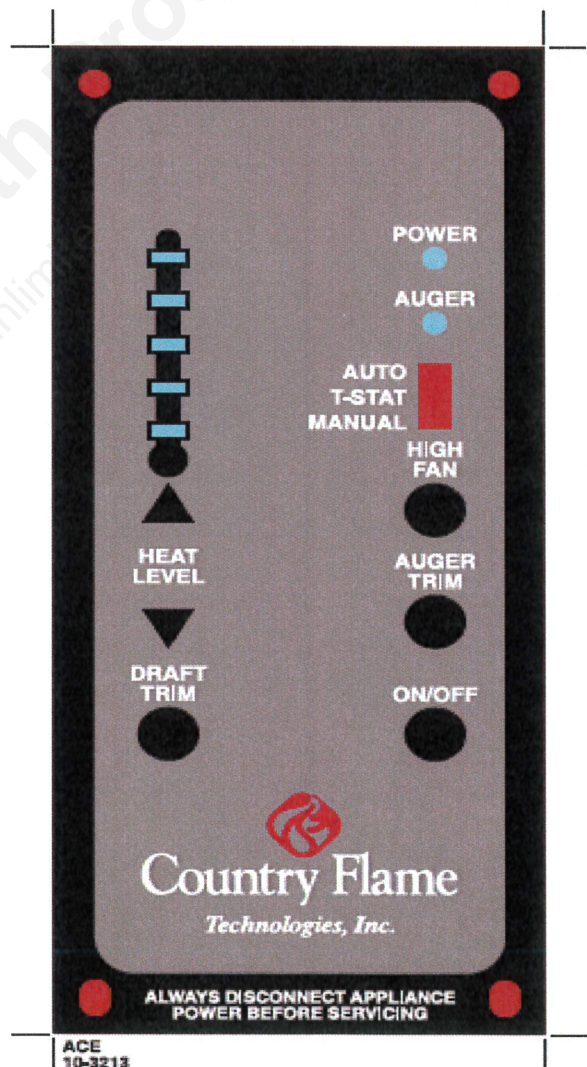

Mountain View Hearth Products
manuals.stove-parts-unlimited.com

“Draft Trim” button along with the heat level button arrow up or heat level button arrow down, depending on desired change.

The auger feed rate on each setting is pre-programmed but may be changed if necessary. The “Auger Trim” button will override the programmed feed rates by +/-5% on all heat levels. To override the feed rate press and hold the ‘Auger Trim’ button along with the heat level button arrow up or heat level button arrow down, depending on desired change.

NOTE: In case of a power outage or interruption lasting longer than 5 seconds, the “On/Off” button must be pushed and held for app. 6 seconds to re-engage the auger. If needed re-light the unit.

NOTE: If the fire is burning too fast and the fuel is being burned up too quickly, turn the air intake butterfly damper closed a little to slow the fire down. This should be done in small 1/4” increments so that the fire doesn’t change too quickly. You can also adjust the draft or auger trim to balance out the burn rate.

NOTE: When changing the heat levels there will be a delay so the system can complete the cycle before switching to the new heat level.

NOTE: In case of a power outage, the pressure switch has tripped, the door has been opened, the hopper door has been left open or any power interruption lasting longer than 5 seconds, the “On/Off” button must be pushed and held for app. 6 seconds (or until you here a click) to re-engage the auger system.

IMPORTANT: The circuit board will not function properly if the outlet is not a constant 120 volt, 60 cycle power source. The outlet must be grounded properly and have the correct polarity. A polarity and ground tester can be picked up at any hardware store to assure proper operation. If you are using a power generator, solar power or wind generation make sure that you have a constant correct power source.

The unit’s electrical warranty would become void if a constant power source is not available. Also make sure that a proper surge protector is between the unit and the power source. The circuit board will not be warranted if there is not a surge protector installed to the unit.

It is strongly recommended that you unplug the power source during times when the unit is not being operated to protect the unit from power surges, power spikes and drops in power. It is very common for a circuit board to work when the unit is shut off in the spring and then won’t work in the fall. Unplugging the unit will prevent this from happening.

Mountain View Hearth Products
manuals.stove-parts-unlimited.com

OPERATING INSTRUCTIONS

(Without using system igniter)

NOTE: Before the stove is started, the firepot should be checked for debris and clear air holes. Some fuels will cause the firepot to build up more frequently making it necessary to stir and clean the firepot more often. Do not allow ash to build up underneath the firepot.

Your control panel has three (3) separate modes of operation (switch located on top of board). The MANUAL setting allows the operator to choose heat level setting changes without a thermostat. The T-STAT setting allows the operator to set the high heat level setting and when the thermostat is satisfied, the unit will automatically go to the low heat level setting. The AUTO setting allows the unit to shut completely off when the thermostat is satisfied and re-start when the thermostat calls for heat. The AUTO setting can only be used with wood pellets.

Before lighting your Country Flame for the first time make sure that all items are out of the hopper and firebox area. Note: If using a wall thermostat, make sure that the thermostat is turned up above room temperature. The unit will operate on low fire if the thermostat is turned down.

- ✓ Load the hopper with fuel (Wood Pellets).
- ✓ Place a small handful of wood pellets or fire starter in the firepot.
- ✓ Squirt a small amount of fire starter gel on top of the wood pellets.
(Evenly across the wood pellets)
- ✓ Light the fire starter gel.
- ✓ Close the door
- ✓ Push the "On/Off" button.
- ✓ Turn the air intake butterfly damper to approximately ¼ inch open. (More or less as needed.)

NOTE: Priming the auger is required when the unit is new or when the hopper has completely run out of fuel. This can be done approximately 1 minute after pushing the on/off start button. Press and hold the "auger" button until fuel begins to drop into the firepot. When fuel begins to drop regularly, release auger button, the auger is primed.

NOTE: The viewing door, ash pan door and hopper door must be closed and/or latched during operation or the vacuum will not be established. If vacuum can not be established the stove will shut down and the #2 heat level setting light will blink.

The ON/OFF button must be pushed and held for app. 6 seconds to reset the system.

The unit starts on a pre-set heat level setting. After the unit has been turned on you may select the desired heat level. However, the feed rate heat level will not change until the unit has completed the 15 minute startup sequence. It is recommended to burn the unit on the number #2 or #3 heat level setting for the first 30-45 minutes.

If the fire temperature has not reached proper operating temperature within the minimum cycle time (15 min.) the auger will stop feeding, the stove will shut down and the #3 heat level setting light will blink. You will need to press and hold the ON/OFF button for 6 seconds to start the cycle over again. If the system is set on auto start it will attempt two startups on its own.

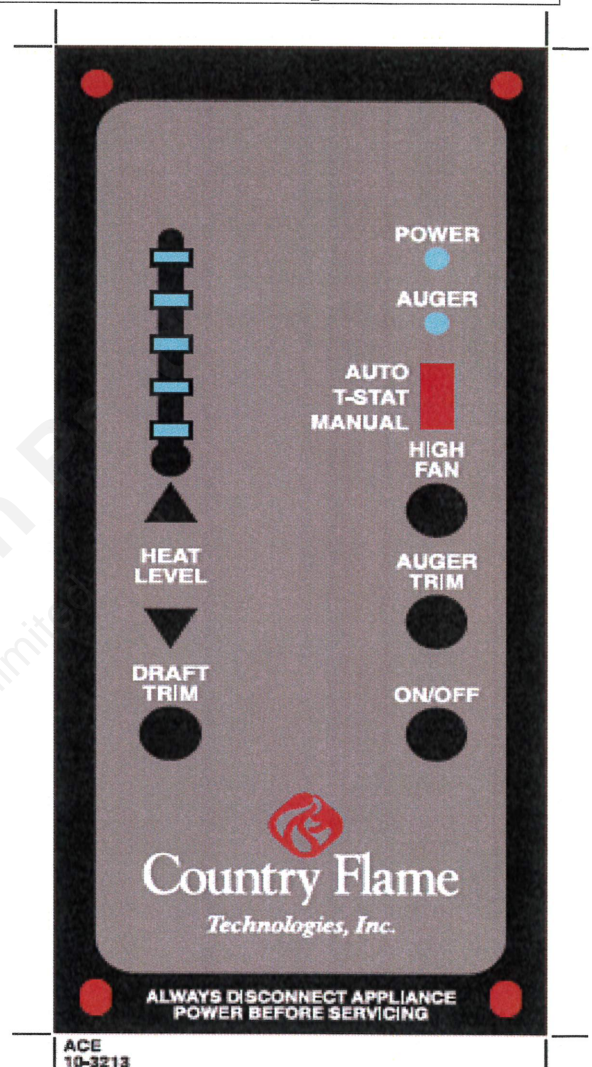

Mountain View Hearth Products
manuals.stove-parts-unlimited.com

The draft and room air blower speed varies directly with the feed rate. The “Draft Trim” button will override the variable fan function +/- 5 volts on all heat levels. To override, press and hold the “Draft Trim” button along with the heat level button arrow up or heat level button arrow down, depending on desired change.

The auger feed rate on each setting is pre-programmed but may be changed if necessary. The “Auger Trim” button will override the programmed feed rates by +/-5% on all heat levels. To override the feed rate press and hold the ‘Auger Trim’ button along with the heat level button arrow up or heat level button arrow down, depending on desired change.

NOTE: In case of a power outage or interruption lasting longer than 5 seconds, the “On/Off” button must be pushed to re-engage the auger. If needed re-light the unit.

NOTE: If the fire is burning too fast and the fuel is being burned up too quickly, turn the air intake butterfly damper closed a little to slow the fire down. This should be done in small 1/4” increments so that the fire doesn’t change too quickly. You may also adjust the draft and auger trim to balance the burn rate.

NOTE: When changing the heat levels there will be a delay so the system can complete the cycle before switching to the new heat level.

NOTE: In case of a power outage, the pressure switch has tripped, the door has been opened, the hopper door has been left open or any power interruption lasting longer than 5 seconds, the “On/Off” button must be pushed and held for app. 6 seconds (or until you here a click) to re-engage the auger system.

IMPORTANT: The circuit board will not function properly if the outlet is not a constant 120 volt, 60 cycle power source. The outlet must be grounded properly and have the correct polarity. A polarity and ground tester can be picked up at any hardware store to assure proper operation. If you are using a power generator, solar power or wind generation make sure that you have a constant correct power source.

The unit’s electrical warranty would become void if a constant power source is not available. Also make sure that a proper surge protector is between the unit and the power source. The circuit board will not be warranted if there is not a surge protector installed to the unit.

It is strongly recommended that you unplug the power source during times when the unit is not being operated to protect the unit from power surges, power spikes and drops in power. It is very common for a circuit board to work when the unit is shut off in the spring and then won’t work in the fall.

Unplugging the unit will prevent this from happening.

Before starting the Country Flame Biomass unit again, it is important to remember to clean out the firepot, empty the ashes, clean out the heat exchangers, vacuum out the hopper if needed and fill the hopper with fuel.

Basic Circuit Board Functions (expanded)/Diagnostics Operation

The ON/OFF button initiates the start of the circuit board and the shut down of the board. Pushing the ON/OFF button momentarily will engage the start up sequence. The ON/OFF button also is used to re-set the board when the vacuum switch or proof of fire switch is tripped. Pushing the ON/OFF button until the board re-sets (usually 6-7 seconds) will re-establish the system and the fire will continue unless there is a failure in the electrical components.

When you push the ON/OFF button to start the unit, power light will be on and the start up sequence will take approx. 12-15 min. During the start up sequence, the fuel level setting will be over ridden and the unit will feed at the pre-set fuel rate setting. After the start up sequence has been established (approx. 12-15 min.) the unit will run at whatever fuel level setting you

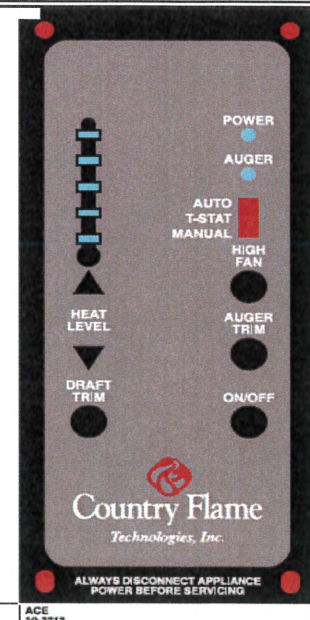

Mountain View Hearth Products
manuals.stove-parts-unlimited.com

selected. The number #2 or #3 heat level setting is recommended for the 1st 30-45 minutes.

The auger light will flash when the auger is running. On the wood setting the auger will start right away. If on the corn setting there is a (2) minute delay prior to starting. You can hold the auger button down to override the system and manually prime the auger.

The room fan button will override the # 1 heat level setting fan speed and go to high speed. This will not change the fan speed on the #2 - #5 heat level settings.

The auger trim button allows for a low/high fuel setting fine tune adjustment on the all 5 settings. When pushing the auger trim button select either the heat level up button or heat level down button depending on the fine tune requirements.

The draft trim allows for a low/high setting fan speed and go to a lower or higher setting depending on requirements. When pushing the draft trim button select either the heat level up button or the heat level down button to fine tune fan speed.

The heat level setting button is a manual heat adjustment. Pushing the heat level setting button will advance the heat settings one level each time that it is pushed. The LED light will show which heat level setting the unit is on. At start up, regardless of where the heat level setting button is set, the unit will feed on the pre-set heat level setting. Once the start up sequence has been established, the fuel feed rate setting will run at whatever fuel level setting you selected.

During a short power outage, the board will detect if the proof of fire switch is engaged. If it is still engaged (closed) the unit will auto re-start.

Shutdown

To shut the unit down, simply press the On/Off button. The room fan and exhaust blower will continue to operate until the low limit/cool down sensor tells it that the fire is out. At that point the exhaust fan will continue to run for an additional 15 minutes to make sure there is no exhaust in stove.

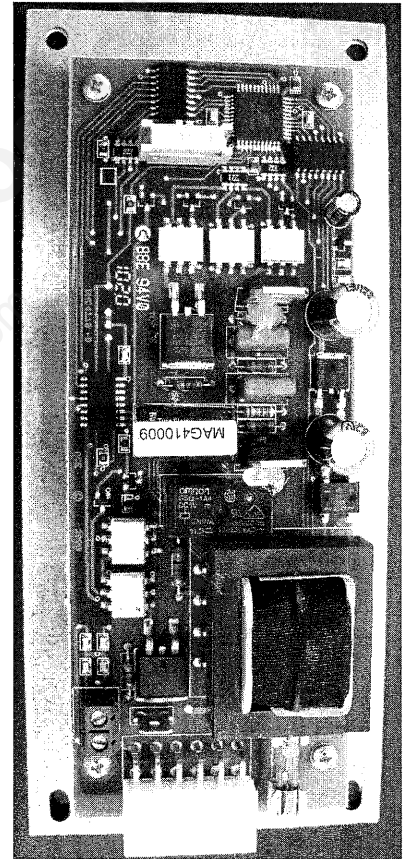

Your control panel comes with the ability to use ten (10) separate programming features. This programming must be done by a qualified factory trained technician. Contact your local dealer to set up an appointment to have this done. The unit also has three (3) separate modes of operation (switch located on top of board). The manual setting allows the operator to choose heat level setting changes. The T-STAT setting allows the operator to set the high heat level setting and when the thermostat is satisfied, the unit will automatically go to the low heat level setting. The AUTO setting allows the unit to shut completely off when the thermostat is satisfied and re-start when the thermostat calls for heat. This setting can only be used with wood pellets.

Mountain View Hearth Products
manuals.stove-parts-unlimited.com

AC MODEL WIRING DIAGRAM

WARNING: DISCONNECT POWER BEFORE SERVICING THIS UNIT.

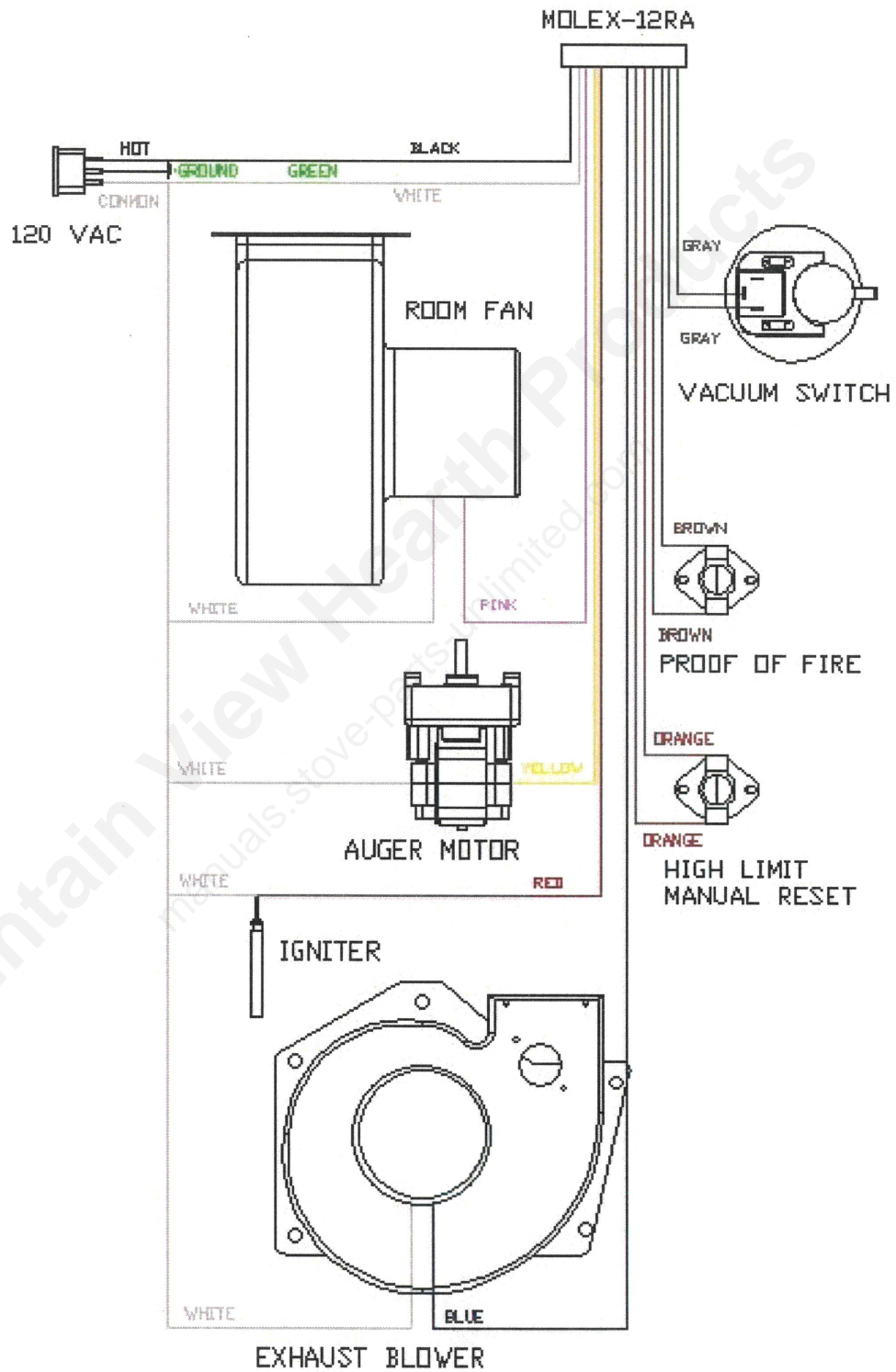

Mountain View Hearth Products
manuals.stove-parts-unlimited.com

MAINTENANCE

1. If pellets contain a large amount of “fines” (foreign matter or sawdust), you will need to clean the heat exchanger area for buildup often to determine if any maintenance is needed. You may want to screen pellets before use if they contain a large number of “fines.”
2. Sand in the pellets may cause “clinkering” (hard brittle deposits found in the bottom of the firepot). Clinkering is primarily caused by fuel impurities, but it may be intensified if the stove is run for a long time with a low amount of fuel. A full load of fuel allows less cool air to enter the burnpot as pellets drop in.
3. A clinker may be removed with a spoon and dropped into the ash pan. NOTE: For your safety, only remove clinkers from stove when unit is cool. When the stove is cold, the firepot can be pulled out and removed for a thorough cleaning.
4. SOOT AND FLYASH: the products of combustion will contain small particles of flyash. The flyash will collect in the exhaust venting system and restrict the flow of the flue gases. Incomplete combustion, such as occurs during start-up, shut down, or incorrect operation of the room heater will lead to some soot formation which will collect in the exhaust venting system. The exhaust venting system should be inspected at least once every year to determine if cleaning is necessary.
5. The frequency of cleaning your unit will depend on the particular installation, fuel and usage of your unit. You will know your stove needs cleaning either by inspection or by a marked decrease in performance. We suggest you check your unit often, especially during its “break-in” period.
6. Shut off the power to the unit and allow it to cool off when performing cleaning and maintenance.
7. The exhaust vent should be checked frequently, at least once a season and cleaned at least once a season.
8. Check to insure that the fresh air intake is clear and unobstructed, especially at the start of the season.
9. The Heat Exchanger has a simple cleaning feature. A sliding plate is fit over the fifteen tubes of the exchanger. The sliding plate is attached to a small rod protruding through the front of the stove just below the louver vent. Push the rod to the back of the exchanger and then pull forward to the front, several times. This will effectively remove ash and debris from the surface of the heat exchanger. Performing this step often will insure that cleaning is an easy task. If buildup is allowed to go unattended, cleanup will be much more difficult and the efficiency of your stove will be adversely affected.

Mountain View Hearth Products
manuals.stove-parts-unlimited.com

10. Remove the ash pan using either the ash pan removal tool (furnished) or a glove. Lift the ash pan up and out the door. Dump the ash pan into a fire safe, covered container. The firepot may be lifted out and dumped using a glove. With these items removed, carefully check that the unit and all ashes are cooled completely. Vacuum out the bottom of the unit, paying close attention to the air inlet. Vacuum the inside of the unit thoroughly cleaning the 2 holes found under the ash pan. Replace all parts once cleaning is completed. This cleaning should be done monthly or as needed to insure proper operation. **An annual cleaning should be accomplished by a certified professional to ensure proper performance.**
11. Depending on usage, both the room air & exhaust blowers may need to be cleaned once a year by vacuuming off the motor and impeller. This simple step will greatly increase the life and serviceability of your unit.
12. To clean glass, use a mild non-abrasive cleaner when cool. Speedy White is an excellent glass and stove cleaner. Creosote builds up on glass quickly when fire is burned at lowest settings. DO NOT use abrasive cleaners on glass. Periodically clean out the door air wash (a groove at the bottom of the door). This air wash directs air over the glass door to minimize soot buildup on the door.
13. Once a year it is advisable to inspect the door gasket. This is done by taking a 2" strip of paper and shutting the door on it. Then pull the paper to test the gasket pressure. You should have to pull the paper from the door. Check all around the gasket. If the paper slides out easily or falls out, the gasket needs to be replaced. We recommend that both the door and glass gasket be replaced at the same time.

To replace the gaskets, remove the door by lifting it straight up, off of its hinge pins and lay face down on a soft surface. Remove door gasketing (you may need to use pliers). Remove glass retaining clips and remove glass. Strip off old gasketing around glass and clean glass well. Clean out old stove gasketing material from gasket track.

Once the door and glass are clean, apply gasketing material to glass surface and return glass to door, securing with clips (**Use care not to over tighten**). Then apply a generous bead of gasketing cement into the track. Position the new gasket into the window frame. Gently press this gasket into the door to ensure proper "seating." Trim off any excess gasketing and wipe away excess cement. Let the cement set 24 hours before placing door back on unit. Gasket material and cement may be obtained from your dealer.

14. Replacement glass should be 0.200" (5mm) thick. Overall size of the glass is 16" (405mm) wide by 11" (279mm) high, cut to an irregular shape to fit the door front. Your unit uses ceramic type high temp glass. Do not use any other glass type in this unit. Replacement glass may be obtained from a Country Flame Dealer or online at www.magnumheat.com.
15. Use care not to slam or strike the door as this could result in glass breakage. If the glass in a pellet stove is broken or cracked, DO NOT operate the unit until the ceramic glass has been replaced.

Mountain View Hearth Products
manuals.stove-parts-unlimited.com

Maintenance Cont.

It is important that the combustion air intake area is kept clean and free from a buildup of ash. Once a week, remove the ash pan and firepot out of the firebox area and clean out the built-up ash using an approved ash vacuum. Using a small cleanout hose (available with ash vac kit), suck the ash out of the air intake and inside of the firebox area so that air can flow easily.

If ash gets way back in the air channels it will restrict air flow and cause the unit to burn dirty and the firepot will overflow with un-burnt fuel.



Clean the area around the igniter tube and carefully clean the end of the igniter of any buildup.

When installing the firepot to its original position, make sure that the firepot is seating down into position and there are no gaps in the bottom of the firepot cradle to the bottom of the unit. If the firepot is not seated properly air will leak and the fire will burn dirty and fuel will build up in the firepot area.

Mountain View Hearth Products
manuals.stove-parts-unlimited.com

INSTALLATION / PRECAUTIONS

IMPORTANT: Read all instructions carefully before starting installation. Failure to follow these installation instructions may result in a possible fire hazard and will void the Country Flame warranty.

1. Look at the label on the back of your unit to find the serial number. Write the serial number of the unit on the Table of Contents page immediately. Failure to do so will make servicing and maintenance questions difficult to answer and could result in needless inconvenience in the future. You will need the serial number of your unit if it requires servicing.
2. When installing appliance
 - A. When installing heater as an insert or as a freestanding unit, adequate clearances must be strictly adhered to.
 - B. Allow for adequate accessibility for servicing and proper operations.
 - C. When establishing clearances, measure from any combustible projection, such as; shelves, windowsills, fireplace mantles above the appliance, etc.
 - D. Proper vent installation is required for safe, reliable operation. Follow vent manufacturers instructions closely.

WARNING: OPERATION OF THIS HEATER WHEN NOT CONNECTED TO A PROPERLY INSTALLED AND MAINTAINED FLUE VENTING SYSTEM IS DANGEROUS.

- **DO NOT** INSTALL A FLUE DAMPER IN THE EXHAUST VENTING SYSTEM OF THIS UNIT.
- **DO NOT** CONNECT THIS UNIT TO A CHIMNEY FLUE SERVING ANOTHER APPLIANCE.
- MAINTAIN VENT PIPE CLEARANCES AS SPECIFIED BY THE VENT PIPE MANUFACTURER.
- IT IS REQUIRED TO PROVIDE A 3" MINIMUM FRESH AIR CONNECTION TO THE APPLIANCE FROM OUTSIDE OF THE HOME. PROPER DESIGN AND INSTALLATION IS REQUIRED.
- IT IS RECOMMENDED FOR SAFE OPERATION OF THE APPLIANCE THAT YOU HAVE A QUALIFIED HVAC CONTRACTOR DETERMINE IF YOUR HOME HAS ANY NEGATIVE PRESSURE PROBLEMS. NEGATIVE PRESSURE WITHIN THE HOME IS DANGEROUS AND WILL CAUSE HEALTH AND SAFETY PROBLEMS. YOUR APPLIANCE WILL NOT BURN CORRECTLY IF YOUR HOME HAS THESE ISSUES.

Mountain View Hearth Products
manuals.stove-parts-unlimited.com

INSTALLATION / FREESTANDING UNIT / POSITIONING

1. When determining the proper location for your unit, keep in mind the heater should be kept out of any traffic paths in the room, away from curtains, drapes or any other combustibles. It should also be placed in a position where heat will be evenly distributed throughout the room.
2. When location has been determined, position the unit within the clearance parameters shown below.
3. **MINIMUM CLEARANCES:** The following diagram provides minimum clearances for the Little Rascal installation based on whether single or double-wall flue pipe and connectors are used.

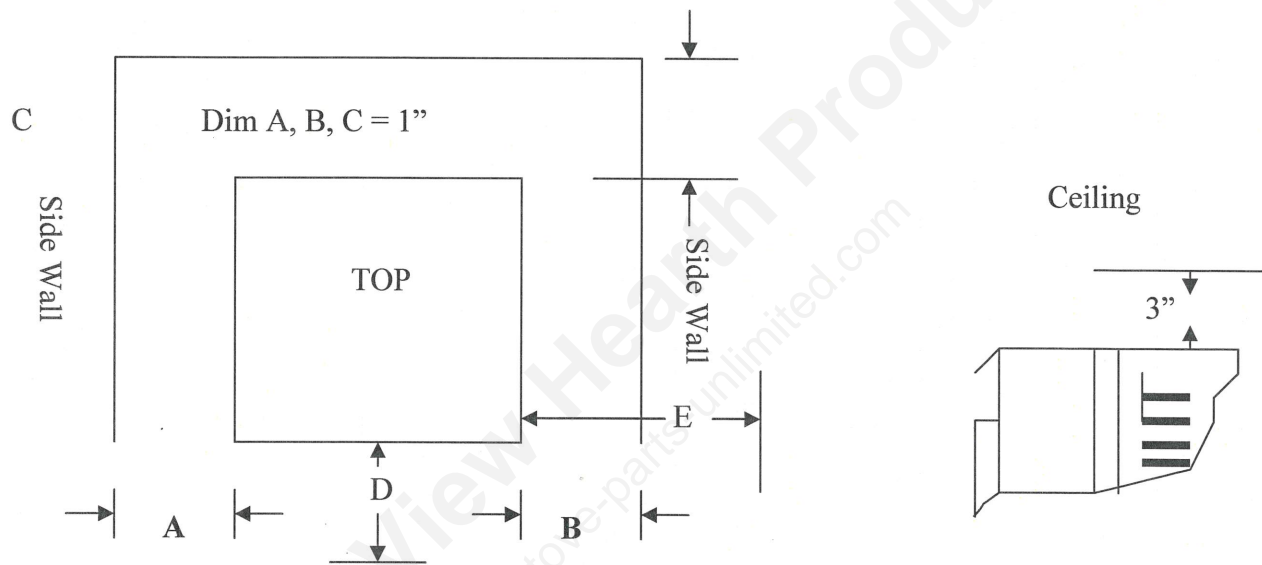

4. If installing a pellet stove on carpet, linoleum or other combustible material, a floor protector is required. It should be at least 42" wide and 30 1/2" deep and placed directly under the pellet stove. This floor protection must be made of metal or some other non-combustible material, such as ceramic tile or brick.
5. Verify that the location for a pellet stove does not interfere or block airflow. The Little Rascal draws air from the side grills on the left and right doors.
6. **WARNING:** ALL combustibles in front of a LR-01 must be kept a minimum of at least 48" (120cm) from the unit. Remember that combustible vapors can travel a long distance.
7. A combustible mantel may be located no closer than 6" (150cm) to the top of a freestanding heater.

Mountain View Hearth Products
manuals.stove-parts-unlimited.com

INSTALLATION / FREESTANDING UNIT / VENTING

1. After positioning the Little Rascal in its final position, proper flue venting must be installed according to local and national codes. The LR-01 is a rear vented unit and flue vent pipe can be run directly from the rear of the unit. Proper venting can be achieved by installing 3" TYPE PL double wall vent pipe according to code requirements. Country Flame requires the use of 4" flue vent pipe if lengths of ten feet or greater are to be used in a specific installation. Pellet flue pipe manufacturers' instructions should be consulted for detailed installation instructions of their product. These same manufacturers provide detailed drawings of venting configurations, which meet or exceed code requirements. This information is available from hearth dealers or can be downloaded from specific websites.

**FOLLOW ALL VENT MANUFACTURER'S VENTING INSTRUCTIONS.
INSTALLATION DRAWINGS ARE FOR ILLUSTRATION PURPOSES ONLY.**

WARNING: Operation of the Little Rascal Model LR-01 is dangerous when not connected to a properly installed; code approved, and maintained flue pipe and fresh air intake system.

2. The venting of this unit should NOT be connected to a flue serving another appliance.
3. At least a 3" clearance is required from all combustibles to the vent pipe, when using required TYPE PL double wall vent pipe with stainless steel liner. This includes the area(s) where the pipe passes through the roof. This clearance is generally met by installing flashing in roofs and fire stop spacers between floors and ceilings. A thimble is needed for through wall applications. Do not install a flue damper in this system.
4. Install the vent pipe directly onto the vent adaptor on the back of the unit. Be sure to push firmly into position. Each flue pipe joint needs to be joined tightly with at least (3) sheet metal screws and sealed with RTV silicone or aluminum flue tape. Air tight venting is required of each flue pipe joint.

NOTE: IT IS REQUIRED (ESPECIALLY IN MOBILE HOMES), THAT INSTALLATIONS USE OUTSIDE COMBUSTION AIR FOR THE PELLET STOVE. IF ROOM AIR IS USED FOR FRESH COMBUSTION AIR, YOU MAY HAVE PROBLEMS WITH NEGATIVE PRESSURE WITHIN THE HOME CAUSING SERIOUS COMBUSTION ISSUES.

5. When using outside air, the metal rigid or flexible inlet pipe should have a mesh screen to prevent rodents or birds blocking the pipe, also an elbow or shield should be used to prevent prevailing winds from blowing directly into the air intake. For best efficiency, locate air inlet 24" (607mm) or more from exhaust vent pipe.
6. The LR-01 is designed to accept installations using a horizontal vent through an exterior wall. A horizontal flue pipe installation should be a minimum of 24" from pellet stove vent pipe to flue cap connection. FIGURE 1 shows a through the wall exterior vent installation.

Mountain View Hearth Products
manuals.stove-parts-unlimited.com

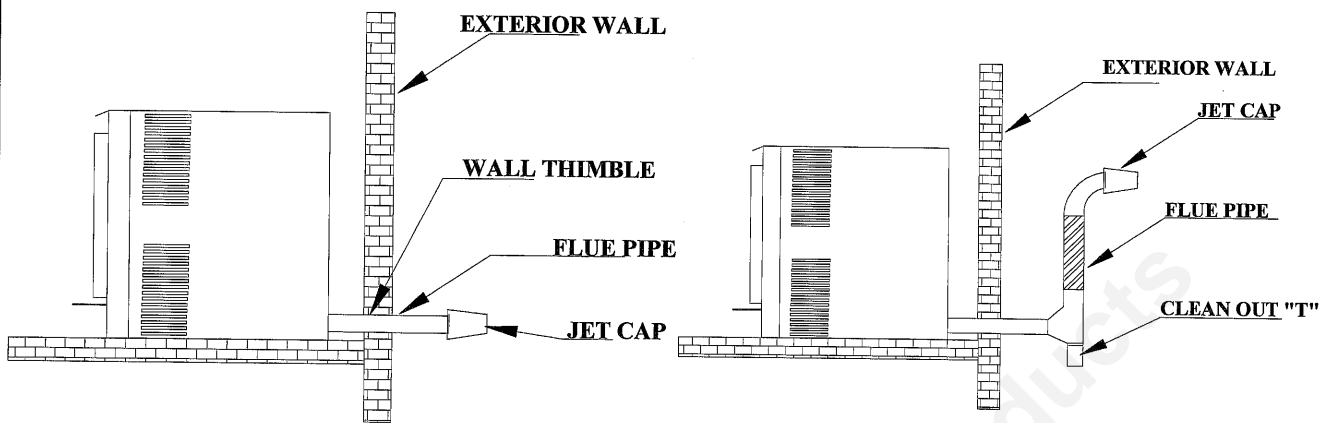

FIGURE 1: HORIZONTAL VENT PIPE (2 options)

7. FIGURE 2 shows a traditional, as well as more efficient, flue pipe installation. Note the dimensions that are required to be maintained in this type of installation. Dimensions are A equals a minimum of 24", B equals a minimum of 3", and C equals a minimum of 6". Again, check with the flue pipe manufacturer's installation instructions and code requirements for exact specifications. DIMENSIONS:

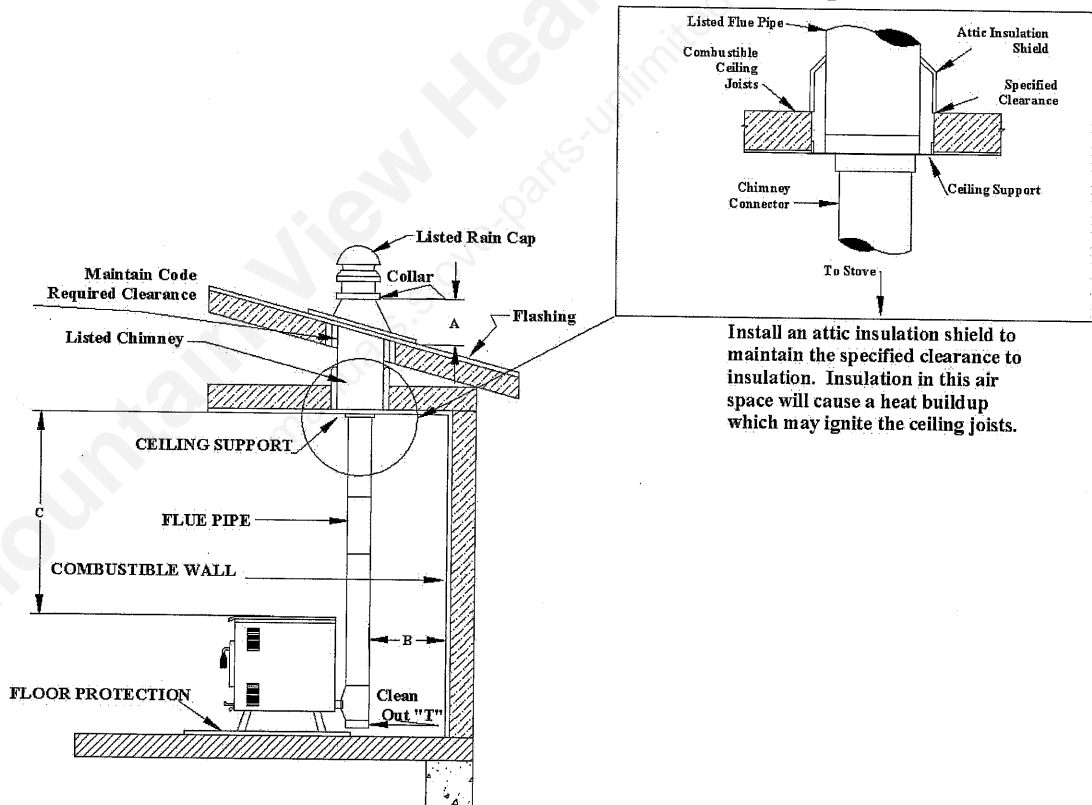

FIGURE 2: TRADITIONAL VENT PIPE

Mountain View Hearth Products
manuals.stove-parts-unlimited.com

8. For installations that pass through a vertical wall and not through the roof, The Factory recommends an installation similar to the one shown in FIGURE 3. Dimension A should be a minimum of 16" and dimension B should be a minimum of 3". Any outside vent should have a vertical run of at least 5'. At the same time, ensure that termination of the flue pipe does not occur just under the roof overhang. Such a termination can cause smoke to seep back through the roof and into the home. For all flue pipe runs over 5', there should be a flue support no less than 5' apart.

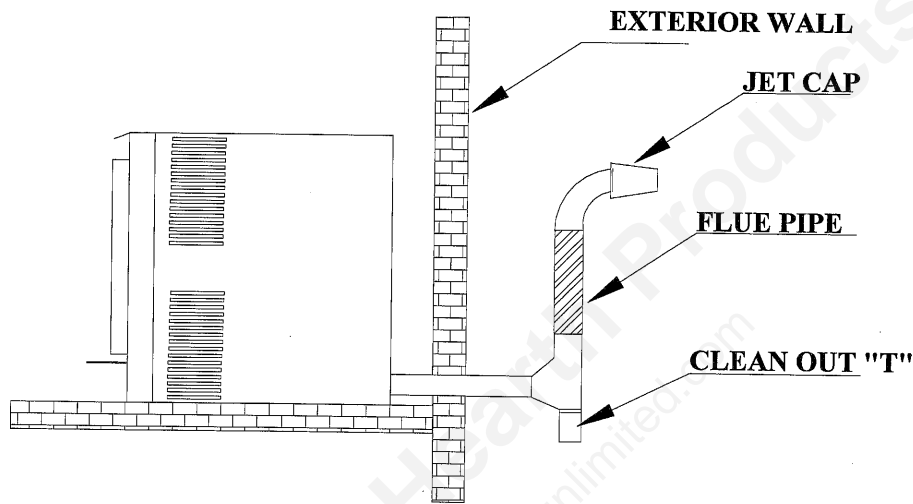

FIGURE 3: RECOMMENDED EXTERIOR WALL INSTALLATION

All installations **MUST** include a fresh air combustion pipe at least 3" diameter. Such a pipe can be rigid metal, or flexible metal pipe. In newer homes, it is strongly recommended that an exterior fresh air combustion vent be installed to ensure proper amounts of air are provided to the pellet stoves combustion chamber.

Mountain View Hearth Products
manuals.stove-parts-unlimited.com

INSTALLATION / FREESTANDING UNIT / DETAIL

The flue vent exit shall be located not less than 48" from any opening through which exhaust could enter the building, (i.e. windows and doors), and not less than 24" from adjacent public walkways. It shall be arranged so that flue gases are not directed in such a way as to pose a health hazard, overheat combustible structures or enter any building. Do not terminate the exhaust flue pipe in an attic, garage, carport or any enclosed or semi-enclosed area, under a porch or sun deck, or near shrubs or combustibles stored near the outlet.

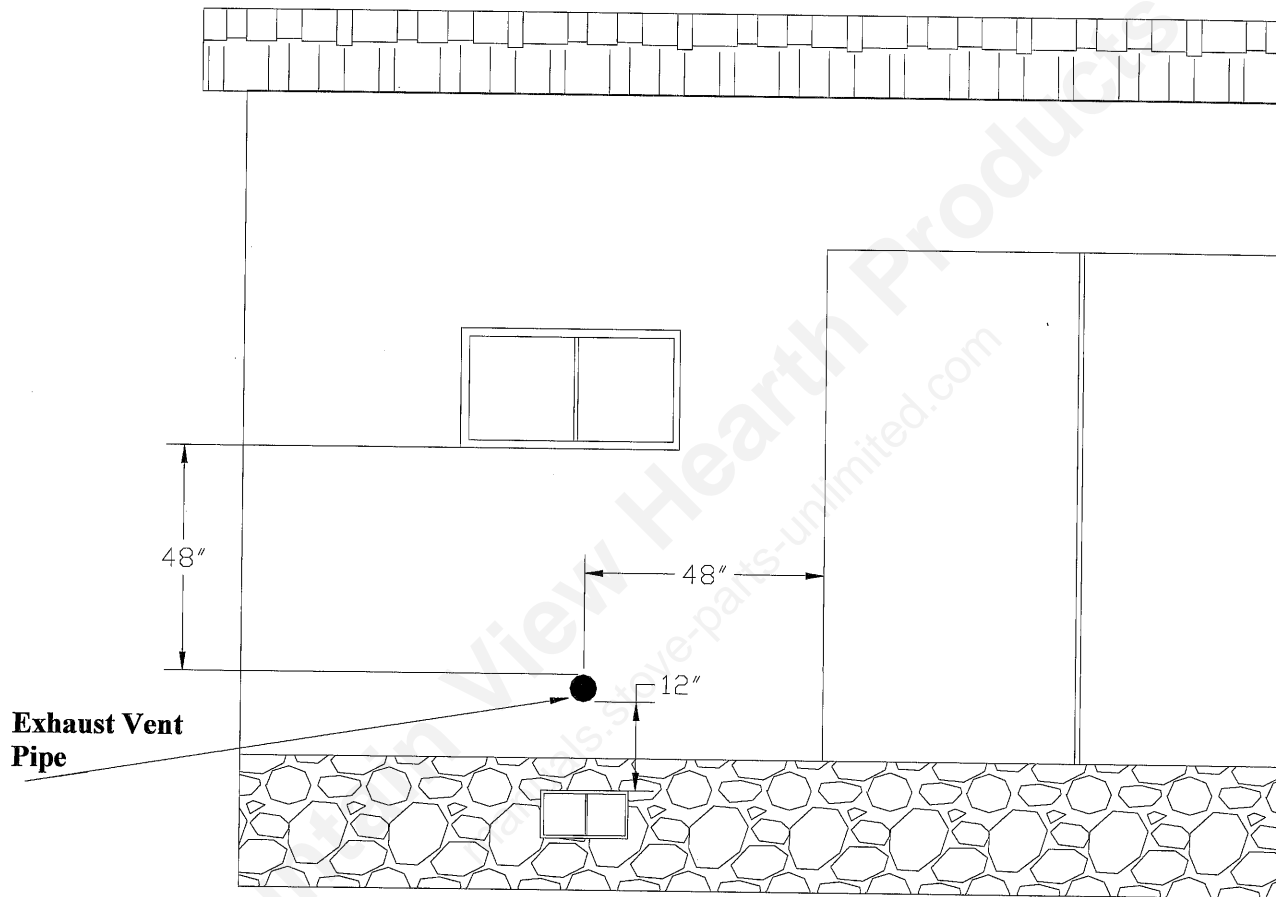

FIGURE 4: EXTERIOR MINIMUM CLEARANCES

FROM VENT EXIT TERMINAL
TO DOORS, WINDOW, OPENINGS

HORIZONTAL: 48"

BELOW OPENINGS: 48

ABOVE OPENINGS: 12

ADJACENT WALKWAYS: 24"

BG

Mountain View Hearth Products
manuals.stove-parts-unlimited.com

INSTALLATION / FREESTANDING UNIT / DETAILS

LEG INSTALLATION / FREESTANDING UNIT / DETAILS

1. Locate the eight (8) bolts in the package that comes with the leg kit.
2. Bolt the four (4) legs to the bottom of the pellet stove using two bolts per leg for a total of eight (8) bolts through the holes provided at the bottom corner of each unit.
3. Use the leveling bolts provided to level the pellet stove. The pellet stove should be level or slightly declined from front to back. **If this is not done, “bridging of pellets” may occur once the stove is operated.**

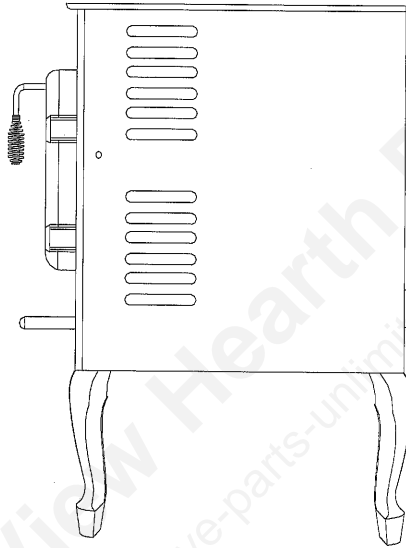

FIGURE 5: LEG INSTALLATION

Mountain View Hearth Products
manuals.stove-parts-unlimited.com

INSTALLATION / INSERT UNIT / POSITIONING

1. The LR-01 insert is designed to be inserted into an existing masonry fireplace or zero clearance box. The suitability of the existing firebox needs to be determined. You should insure that the heater is kept out of any traffic paths in the room, away from curtains, drapes or any other combustibles. You should also check that the existing fireplace was placed in a position where heat will be evenly distributed throughout the room.
2. If the existing fireplace is found to be suitable, the LR-01 may be installed using zero clearance.
3. While installing the LR-01, verify that the location will not interfere with the circulation airflow. The unit draws air from the grills on both sides of the unit.
4. The heater should be installed in such a manner so that the front of the unit remains unblocked. This will allow for needed service and maintenance to the unit, and provide access to the firepot cleanout.

CLEARANCES FOR INSERT:

DIMENSIONS:

A = 3"

B = 6"

C = 6"

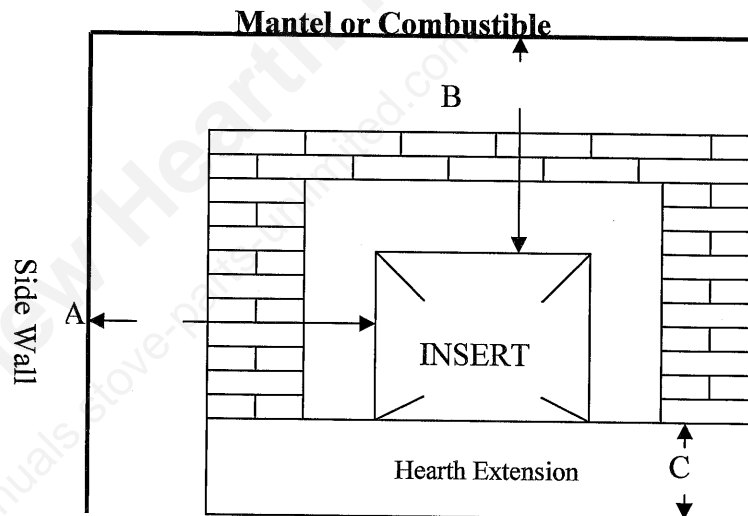

FIGURE 7: INSERT MINIMUM CLEARANCES

Mountain View Hearth Products
manuals.stove-parts-unlimited.com

INSTALLATION / INSERT UNIT / VENTING

1. The LR-01 is designed for both new installations and as an insert into existing fireplaces. The LR-01 is NOT designed to be installed without proper vent pipe. Proper venting can be achieved by installing a 3" (less than ten feet) or 4" (more than ten feet) TYPE PL double wall vent pipe or listed TYPE "L" chimney liner. A listed single wall stainless steel liner may be used if installing the LR-01 into an approved wood burning chimney. The vent pipe may be run to the top of the existing chimney or to a point 18" above the damper of the existing chimney. Flue pipe manufacturer's instructions should be consulted for further detailed pipe installation instructions. Most flue pipe manufacturers will provide detailed drawings of venting plans, which meet or exceed code requirements. NOTE: Follow all vent manufacturers vent pipe instructions without deviation. Check local codes to ensure conformance.
2. **WARNING: DO NOT** operate any pellet stove unless connected to proper flue system. Do not connect the LR-01 to a chimney flue serving another appliance.
3. Flue pipe joints need to be joined tightly to ensure air tight venting with at least (3) sheet metal screws and sealed with RTV silicone or approved aluminum flue pipe tape.
4. FIGURE 8 shows a sample of a factory recommended method of flue pipe installation. The vent pipe is extended just above the top of the existing chimney (consult local ordinances for code requirements.) The flue pipe must be fitted with a proper pellet flue cap. A storm collar and flashing should be installed to seal off the chimney opening.

Mountain View Hearth Products
manuals.stove-parts-unlimited.com

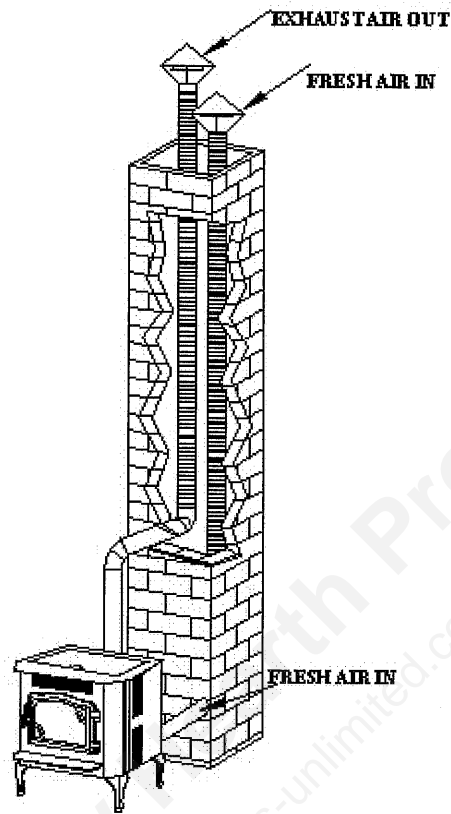

FIGURE 8: CHIMNEY FLUE AND FRESH AIR VENTING

Mountain View Hearth Products
manuals.stove-parts-unlimited.com

INSTALLATION / MOBILE HOME STANDARDS

1. Mobile home code requires the pellet stove be bolted to the floor regardless of whether it has legs or is mounted on its optional pedestal.
2. A pellet stove must be electrically grounded to the steel frame of the mobile home.
3. A pellet stove must have an outside combustion air source installed in a mobile home.
4. **CAUTION:** THE STRUCTURAL INTEGRITY OF THE MOBILE HOME (floors, walls, ceilings and roof) MUST BE MAINTAINED.
5. **WARNING:** DO NOT INSTALL A PELLETT STOVE IN A SLEEPING AREA.
6. Check any other local building codes as they apply.

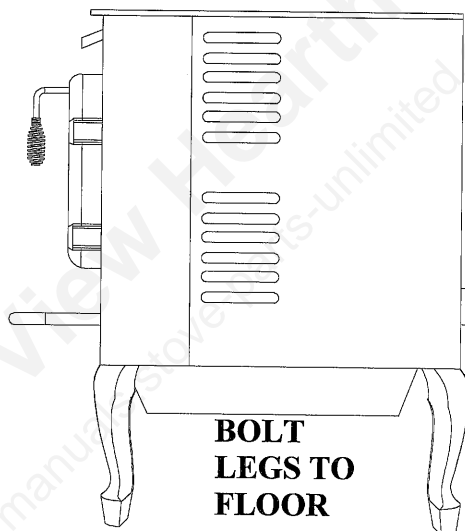

FIGURE 11: MOBILE HOME LEG INSTALLATION

HEATER COMPONENTS: PLATES AND TAGS

A safety label is shown in FIGURE 14 for informational purposes. Refer to the back of a LR-01 pellet stove for the actual safety label. Illustrations are artist renderings and the actual label on a product may vary slightly in information and design.

Each LR-01 has a serial number fixed to the certification label attached to the back of the unit. Record the serial number in the owner's manual for future reference.

1. A label on the back of the unit warns that the stove is hot. See the safety section of your owner's manual for more safe operating tips.

Mountain View Hearth Products
manuals.stove-parts-unlimited.com

- Information and warning labels are located under the hopper lid. These labels provide information on operation and maintenance that the operator should always follow when operating the stove. Keep the hopper lid closed during operation.
- There are electrical warning labels inside the LR-01 that inform the consumer that before any electrical service is attempted on a unit, disconnect the unit from the source power before servicing. Also, the warning labels inform the consumer that the unit should not be run with covers removed.



UL CLASSIFIED
ELECTRICAL SAFETY
US

TYPE EHS1

**LISTED PELLET FUEL BURNING SPACE HEATER/FIREPLACE INSERT
ALSO SUITABLE FOR MOBILE HOME INSTALLATION**

MODEL LR-01

SERIAL #

THIS APPLIANCE HAS BEEN TESTED BY
WARDLOCK HERVEY, INC.
Tested Per: ASTM E1995-04, UL 1484, UL6 6201,
UL6009-21 4th, (and UL6 6201 F listed for fireplace
insert installation in Canada)

MANUFACTURED BY: AMERICAN ENERGY SYSTEMS, INC.
188 RICHMOND STREET DE
HUTCHINSON, MN 55350

INSTALL AND USE IN ACCORDANCE WITH MANUFACTURER'S INSTALLATION AND OPERATING INSTRUCTIONS.
CONTACT LOCAL BUILDING OR FIRE OFFICIALS ABOUT RESTRICTIONS AND INSTALLATION INSPECTION IN YOUR AREA.

A 3" (76mm) OR 4" (102mm) TYPE "PL" VENTING SYSTEM OR LISTED TYPE "L" CHIMNEY USED. SEE LOCAL BUILDING
CODE AND APPLIANCE AND VENT MANUFACTURER'S INSTRUCTIONS FOR PRECAUTIONS REQUIRED FOR PASSIVE
VENTING SYSTEM THROUGH A COMBUSTIBLE WALL OR CEILING.

OPERATE UNIT ONLY WITH DOORS FULLY CLOSED
REPLACE GLASS ONLY WITH CERAMIC GLASS
START STOVE BY PUSHING ON/OFF ROCKER SWITCH TO ON POSITION
STOP STOVE BY PUSHING ON/OFF ROCKER SWITCH TO OFF POSITION

THIS APPLIANCE QUALIFIES AS A NON-AFFECTED FACILITY ACCORDING TO
U.S. ENVIRONMENTAL PROTECTION AGENCY

CAUTIONS

WARNING: DO NOT INSTALL IN A
MOBILE HOME SLEEPING ROOM

FOR USE WITH PELLETTIZED WOOD FUEL
ONLY.
USE OF OTHER FUELS MAY DAMAGE UNIT
AND CAUSE A HAZARDOUS CONDITION.

DO NOT CONNECT THE
UNIT TO A CHIMNEY
SERVING ANOTHER
APPLIANCE.



**FREESTANDING
CLEARANCES**

A = 1" (25mm)
B = 6" (152mm)
C = 6" (152mm)
D = 2" (51mm)

INSTALL ON A NON-COMBUSTIBLE FLOOR PROTECTOR EXTENDING UNDER THE APPLIANCE (SEE FLOOR
PROTECTION INSTRUCTIONS)
WARNING: IF INSTALLED AS FREESTANDING, UNIT MUST BE INSTALLED WITH LEGS OR FEET/STAIL PROVIDED.
DO NOT OBSTRUCT SPACE BENEATH HEATER.

**ELECTRICAL
REQUIREMENTS:**
120 VOLTS
2.4 AMPS
60 Hz
ROUTE POWER CORD
AWAY FROM UNIT

INPUT RATING:
40,000 BTU/H

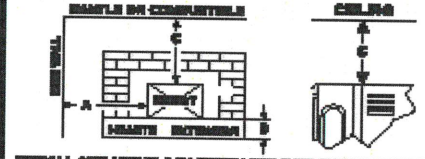

**INSERT
CLEARANCES**

A = 1" (25mm)
B = 6" (152mm)
C = 4.6" (117mm)

INSTALL AND USE IN A FACTORY-BUILT OR MASONRY FIREPLACE.
DO NOT REMOVE BRICKS OR MORTAR FROM MASONRY FIREPLACE.
USE A LISTED FLOOR PROTECTOR OR ANY EQUIVALENT NON-COMBUSTIBLE MATERIAL.



**CAUTION: HOT WHILE IN OPERATION. DO NOT TOUCH. KEEP CHILDREN,
SKIN BURNS. SEE NAMEPLATE AND INSTRUCTIONS. OPERATE THIS UNIT ONLY WITH
THE FUEL HOPPER LID CLOSED. FAILURE TO DO SO MAY RESULT IN EMISSION OF
PRODUCTS OF COMBUSTION FROM THE HOPPER UNDER CERTAIN CONDITIONS.
MAINTAIN HOPPER SEAL IN GOOD CONDITION. DO NOT OVER FILL THE HOPPER.**

DATE OF MANUFACTURE

'08 '09 '10 '11 '12 JAN FEB MAR APR MAY JUN JUL AUG SEP OCT NOV DEC

MADE IN U.S.A.

DO NOT REMOVE THIS LABEL

100

Mountain View Hearth Products
manuals.stove-parts-unlimited.com

AMERICAN ENERGY SYSTEMS INC. LIMITED PRODUCT WARRANTY

This warranty is in effect on all products sold after 01/01/2009 and supersedes any and all warranties currently in existence.

Please keep a copy of this warranty for your personal records or in the event of a claim

American Energy Systems Inc., hereinafter referred to as (AES), warrants to you, the original consumer purchaser, that this product is free from defects in material and workmanship for a period of five (5) years from the original purchase date minus any time past one (1) year from manufacturing date, and that the product's electrical parts and steel firepot, are free from defects in material and workmanship for a period of one (1) year from the original consumer purchase date minus any time past one (1) year from manufacturing date, and that the cast iron firepot models carry a lifetime warranty against defect in material or workmanship (excluding war page or deterioration), and that door glass carries a lifetime replacement warranty against heat breakage (does not cover accidental breakage). There is expressly no warranty on installation of product, any venting, grates, gaskets, door latches, insulation, ceramic or brick boards/logs/backing, paint, plated surfaces/doors/trims, baffles, bushings, bearings, auger flightings, war page or discoloration of steel or plated parts or any other normal wearing part. In the event the product fails to conform to this warranty, AES, through the place where you purchased the product or if purchased on the AES E-Com store directly through AES, will provide the parts and components necessary to remedy such nonconformity. **AES will not be responsible for any labor, mileage or freight cost to the factory under this warranty.** This warranty is not transferable.

In order to obtain performance under this warranty, you must (1) have registered this warranty within 30 days of purchase by completing and returning the warranty registration card or filling in the on-line warranty registration form at www.magnumheat.com, and (2) promptly report the claimed nonconformity to your place of purchase, also providing your name, address, phone number, proof of purchase, date of purchase, the model and serial number of the stove, digital pictures of installation and venting inside and outside of the home, pictures of the claimed nonconformity part and the claimed nonconformity. **All claims must be submitted in writing to your place of purchase.**

AES shall have no warranty obligations if this product; (1) was not purchased from an authorized AES dealer; (2) was not installed by a AES dealer or other qualified installer; does not have outside combustion air hooked directly to the unit; (3) was not operated and maintained in strict accordance with the manufacturer's instructions, local or national codes or (4) was subject to abuse, misuse, negligence or accident. AES shall have no warranty obligation for damage caused by improper handling, freight damage (must be reported to freight provider), over-firing, unapproved fuel, variance in feed rates, variances in BTU output or the unauthorized disassembly or modification of the product. AES shall have no warranty obligation if this warranty is not timely registered, for claims which are not submitted through the selling AES dealer, or for claims submitted verbally or without the required information and documentation.

Before exercising this warranty, an AES representative (the place where the product was purchased or AES approved person) must inspect the part/unit to determine if the part/unit is defective. If a local AES representative is not available the original purchaser of the product must submit digital pictures of the part/unit, installation of the unit to AES at technical@magnumheat.com If the inspection reveals that the failure is due to defective material or workmanship and the part is covered by the conditions of this warranty, AES will, at its option, repair the defective part/unit. The sole duty of AES and liability under this warranty is limited to the repair of the covered defective part/unit. The purchaser shall assume all costs related to shipping the replacement parts or return of the unit to the factory for repairs. If it is determined that the defect was caused by AES, AES will cover the costs of shipping the repaired part/unit to an AES approved shipping point. AES will not cover additional freight or delivery services such as residence delivery charges, special handling, etc.

INSTALLATION, VENTING, REMOVAL OR REINSTALLATION COSTS ARE NOT COVERED BY THIS WARRANTY.

THE WARRANTY PRINTED ABOVE IS THE ONLY WARRANTY APPLICABLE TO THE PRODUCT. ALL OTHER WARRANTIES, EXPRESSED OR IMPLIED, INCLUDING, WITHOUT LIMITATION, THE IMPLIED WARRANTIES OF MERCHANTABILITY AND FITNESS FOR A PARTICULAR PURPOSE, ARE DISCLAIMED. IT IS UNDERSTOOD AND AGREED THAT AES'S LIABILITY UNDER THIS WARRANTY SHALL BE LIMITED TO THE PROVISION OF REPLACEMENT PARTS AND SHALL NOT INCLUDE LIABILITY FOR SPECIAL, INCIDENTAL OR CONSEQUENTIAL DAMAGES. ANY ACTION BROUGHT UNDER THIS WARRANTY MUST BE BROUGHT WITHIN ONE YEAR OF THE ACCRUAL OF THE CAUSE OF ACTION AND MAY ONLY BE BROUGHT IN THE CIRCUIT COURT OF MC CLOUD COUNTY, MINNESOTA.

Mountain View Hearth Products
manuals.stove-parts-unlimited.com

Some states do not allow limitations on how long an implied warranty lasts or the exclusion or limitation of incidental or consequential damage, so the above limitations may not apply to you. This warranty gives you specific legal rights, and you may also have other rights which vary from state to state.

ALL WARRANTY CLAIMS MUST BE SUBMITTED IN WRITING THROUGH THE PLACE WHERE THE PRODUCT WAS PURCHASED. In the event where the place of purchase has ceased business or if you feel that there is a legitimate reason that you cannot submit your claim to the place where the product was purchased you may make a written request to the factory by emailing your request along with all of the required information to technical@magnumheat.com . **NOTE: Verbal requests will not be recognized. If it is determined that warranty could have been performed by the place of purchase, the factory will deny the claim.**

Included with the claim must be the following information: (if this information is not complete, the claim will be denied)

Name, address, telephone number, email address, of place of business where product was purchased & also purchaser contact info.

Date of purchase, model and serial number of product, digital pictures of product (front, sides, back, venting inside and outside)

(If there is ductwork, there must be digital pictures of entire ductwork installation, static pressures, air flow measurements, and contact information of licensed/factory certified contractor that installed unit)

Nature of defect, what has been serviced (service record), who installed product along with contact information

Mountain View Hearth Products
manuals.stove-parts-unlimited.com