



# Heritage

(Model 8091)

Pellet Stove

## OWNER'S MANUAL Operating Instructions



Please read this entire manual before installation and use of this pellet fuel burning room heater. Failure to follow these instructions could result in property damage, bodily injury, or even death.

CONTACT LOCAL BUILDING OR FIRE OFFICIALS ABOUT RESTRICTIONS AND INSTALLATION INSPECTION REQUIREMENTS IN YOUR AREA.

SAVE THESE INSTRUCTIONS FOR FUTURE REFERENCE!



We recommend that our products be installed and serviced by professionals who are certified in the U.S. by NFI (National Fireplace Institute).

[www.nficertified.org](http://www.nficertified.org)

Tested & Listed By



Portland  
Oregon USA

OMNI-Test Laboratories, Inc.



Heritage Pellet Model 8091  
Report: 261-S-04b-2  
Manual: 6400-40465-1  
Revision: 8 - 6/12/2012

Intentionally Blank

Mountain View Hearth Products  
manuals.stove-parts-unlimited.com

# Table of Contents

<b>Operation</b> .....	<b>4</b>
Loading Pellets .....	4
Modes of Operation .....	5
Ash Disposal .....	25
<b>Maintenance</b> .....	<b>26</b>
Daily .....	27
Weekly or as Needed .....	27
Monthly .....	27
Yearly or Every Ton of Pellets .....	28
As Needed .....	30
Glass Replacement Procedures .....	31
<b>Troubleshooting</b> .....	<b>32</b>
Display Messages:.....	32
General Issues:.....	34
<b>Replacement Parts &amp; Optional Accessories List</b> .....	<b>36</b>
<b>Safety Label</b> .....	<b>37</b>

Mountain View Hearth Products  
manuals.stove-parts-unlimited.com

# Operation

- 🔥 **CAUTION: HOT WHILE IN OPERATION! KEEP CHILDREN, CLOTHING, AND FURNITURE AWAY. CONTACT MAY CAUSE SKIN BURNS.**
- 🔥 **CAUTION: DO NOT USE CHEMICALS OR FLUIDS TO START THE FIRE.**
- 🔥 **CAUTION: DO NOT BURN GARBAGE, FLAMMABLE LIQUIDS SUCH AS GASOLINE, NAPHTHA, OR ENGINE OIL.**
- 🔥 **CAUTION: THIS UNIT IS DESIGNED TO BURN ONLY PREMIUM NATURAL WOOD PELLETS. DO NOT BURN ANY OTHER MATERIAL NOT DESIGNATED AS WOOD PELLET FUEL. USE OF CHUNK WOOD IN THIS STOVE IS PROHIBITED BY LAW. BURNING ANYTHING OTHER THAN WOOD PELLET FUEL CAN CAUSE OVERFIRING, DAMAGE THE APPLIANCE, AND WILL VOID THE WARRANTY.**
- 🔥 **USE ONLY THE BURN POT DESIGNED FOR THIS STOVE – DO NOT SUBSTITUTE WITH OTHER PARTS OR USE A GRATE TO HOLD THE FUEL.**
- 🔥 **WARNING: DO NOT ABUSE THE FRONT DOOR GLASS BY STRIKING, OR BY SLAMMING THE DOOR.**
- 🔥 **CAUTION: DO NOT OPERATE THIS UNIT WITH BROKEN DOOR GLASS.**
- 🔥 **DO NOT ALLOW FIRE TO BURN TOO CLOSE TO THE GLASS.**
- 🔥 **DO NOT OPERATE WITH THE FRONT DOOR, OR ASH DRAWER OPEN – THE UNIT WILL SHUT DOWN.**
- 🔥 **DISCONTINUE OPERATION IF YOU SMELL SMOKE COMING FROM THE HEATER.**
- 🔥 **IF A MALFUNCTION IS SUSPECTED, TURN THE UNIT OFF USING THE CONTROL PANEL, DO NOT UNPLUG!**
- 🔥 **IF THE FLAMES BECOME SOOTY, OR THE BURN POT OVERFILLS WITH PELLETS, IT IS RECOMMENDED TO TURN OFF THE STOVE AND THOROUGHLY CLEAN ALL STOVE AREAS AS PER MAINTENANCE DIRECTIONS.**
- 🔥 **WHEN OPERATING NORMALLY, THIS APPLIANCE COULD TRIGGER SMOKE DETECTORS INSTALLED TOO CLOSE TO THE UNIT.**

## Loading Pellets

Lift the hopper door vertically until fully opened, open secondary hopper door; add pellets into hopper until full. In order to maximize hopper capacity, push pellets into void spaces. With all voids full, maximum hopper capacity is approximately 50 lbs of pellets. To reduce the introduction of fines, or spillage, we recommend the use of a secondary container to add pellets. Clean up any pellets spilled on, or down inside the stove.

Store pellets in a dry location, and outside the required clearances to combustibles of the heater.

### NOTES:

- 🔥 **WARNING! TOP GRILL AND FRONT EDGE OF STOVE CAN BECOME VERY HOT, AVOID ALL CONTACT WITH HEATED SURFACES**
- 🔥 IF THE HOPPER DOOR IS LEFT OPEN, A **CAP OPEN** MESSAGE WILL SHOW ON THE DISPLAY. AN OPEN HOPPER DOOR WILL AUTOMATICALLY STOP FUNCTION OF THE FEED AUGER, AS THE AUGER POSES A HAZARD TO FINGERS DURING OPERATION. TO ACKNOWLEDGE THIS MESSAGE, SIMPLY CLOSE THE HOPPER DOOR.

All operations of the stove are initiated from the User Interface pad. This pad is designed to provide simple, user-friendly operation of the stove. There are only four buttons on the interface pad, **Power (On/Off)**, **MENU**, **+**, **-**. During normal operation, the interface screen will illuminate red. When the unit is in OFF mode, but power is supplied, the pad will display its operational state without the red backlighting. If an error is detected, an error message is displayed, and the readout will flash.

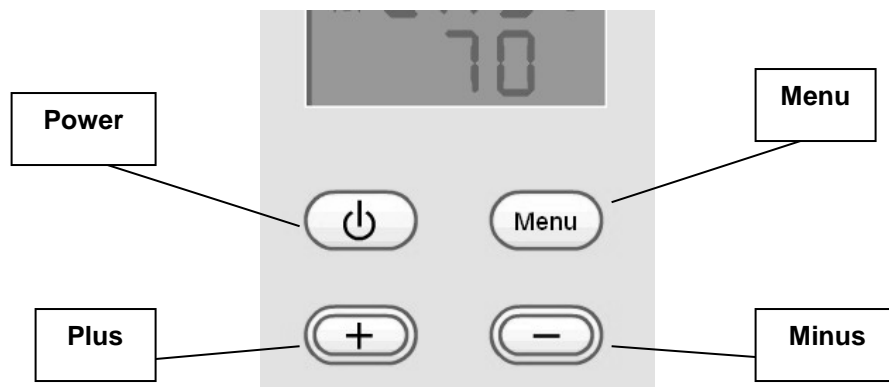

# Operation

## ***Modes of Operation***

The Heritage Pellet Stove has various modes of operation. They are:

- 🔥 **Manual** – Most basic mode (no thermostatic control).
- 🔥 **Thermostat** – Optional mode. Requires an external milli-volt thermostat sold at your local Hearthstone dealer or hardware store.
- 🔥 **Automatic** – Easiest automatic mode. Requires the use of the Hearthstone's Room Sensor (*included with the stove*).
- 🔥 **Programmable** – Best automatic mode. Requires the use of the Hearthstone's Room Sensor (*included with the stove*).

**Note:** If the stove is triggered to shut down and then triggered to turn back on immediately, it will still go through the complete shut down and startup process.

# hearthstone Pellet Stoves

# Basic Setting : MAN Mode

### Operation:

- Operating in the Basic Setting : MAN Mode (Manual mode)
- Turning the stove ON / OFF and adjusting the Heat Output

### Conditions • Stove Plugged In

- No Thermostat Connected
- No Room Sensor Connected

**1 Plug in the stove:**

**2 Turning on the stove:**

**3 Turning off the stove:**

**4 Turning off the stove:**

**5 Adjust the Heat Output:**

**6 Turning on the stove:**

Operation:

- Switching between MAN Mode / TSTAT Mode (Thermostat Mode)
- Operating in TSTAT Mode

Conditions

- Stove Plugged In
- Thermostat Connected (UL apprv Millivolt)
- No Room Sensor Connected

**1 Switching between MAN Mode / TSTAT Modeo, Starting the stove in TSTAT Mode:**

When the Menu button is released, the screen will change to TSTAT Mode.

**PRESS MENU BUTTON** **HOLD 15 SECONDS**

**PRESS POWER BUTTON**

To return to MAN mode, repeat step 1.

This indicates that the stove is in TSTAT Mode. Press the Power Button to start the stove.

Press and release buttons quickly, unless otherwise noted.

This shows the percentage of heat output. **PRESS + or -** to go between 30(%) and 100(%).

The thermostat (connected to the back of the stove) will stop and start the stove, always running at the indicated Heat Output.

Allow up to 10 min. for the stove to react to temperature setting changes.

**3 Running Cycle in TSTAT Mode:**

The stove is igniting, and climbing toward the Heat Output setting.

The stove is stopped.

The stove is in Standing by. Room temp. is satisfied.

Heat Output setting.

**4 Turning off the stove:**

**PRESS POWER BUTTON** **HOLD 3 SECONDS**

This indicates that the stove is OFF.

Operation:

- Switching between MAN Mode / AUTO Mode (Automatic Mode)
- Operating in AUTO Mode

Conditions

- Stove Plugged In
- No Thermostat Connected
- Room Sensor Connected

**1 Enter the Advanced Setting:**

To return to MAN mode, repeat step 1.

The TSTAT OFF screen indicates that you are in the Advanced setting.

**2 Enter the MODE menu:**

Press and release buttons quickly, unless otherwise noted.

Press the Menu Button to scroll to the MODE screen.  
Press the Power Button while on the MODE screen to enter the Mode menu.

Operation:

- Switching between MAN Mode / AUTO Mode (Automatic Mode)
- Operating in AUTO Mode

Conditions

- Stove Plugged In
- No Thermostat Connected
- Room Sensor Connected

**3** Selecting AUTO Mode:

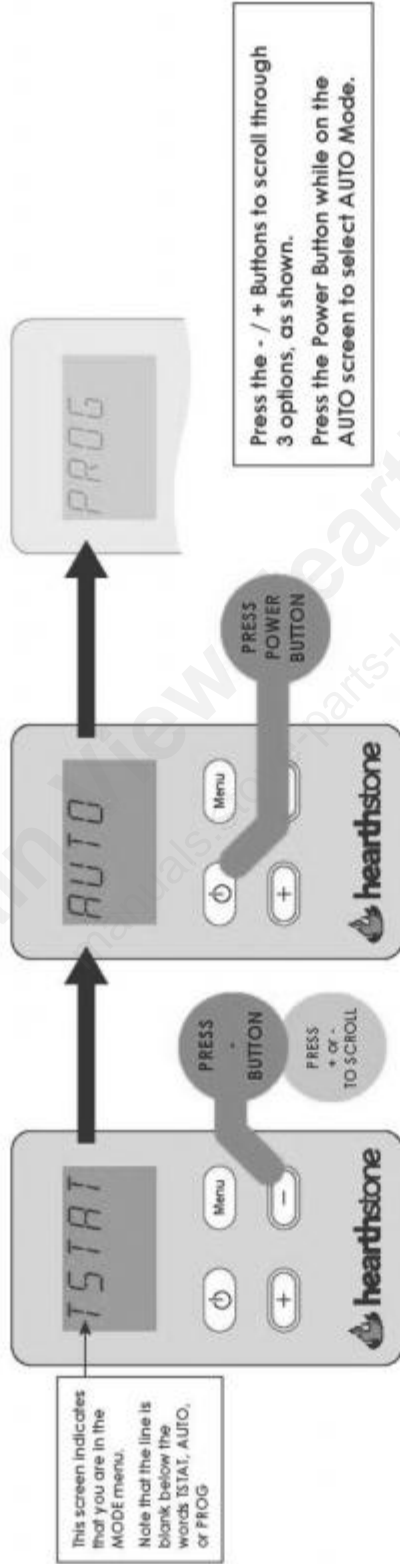

**4** Starting your stove in AUTO Mode:

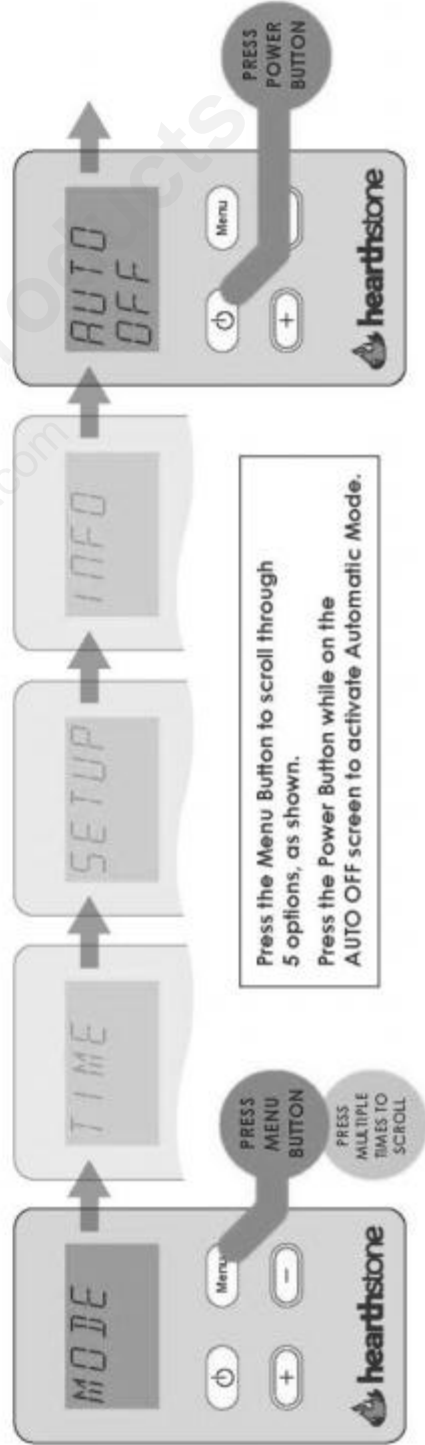

# hearthstone Pellet Stoves

# Advanced Setting :AUTO Mode

### Operation:

- Switching between MAN Mode / AUTO Mode (Automatic Mode)
- Operating in AUTO Mode

### Conditions

- Stove Plugged In
- No Thermostat Connected
- Room Sensor Connected

### 5 Adjusting the Heat Output:

The Home temp. setting can be adjusted at any stage of the running cycle (running cycle shown in Step 22)

This indicates that the stove is in Automatic Mode.

This shows the target room temperature in degrees Fahrenheit.  
PRESS + or - to increase or decrease the temperature setting by 1°F.  
The Room Sensor will sense the temperature of the room, and run the stove in order to maintain the set temperature.

PRESS + or - BUTTON

Allow up to 10 min. for the stove to react to temperature setting changes.

### 6 Turning off the stove:

PRESS POWER BUTTON

HOLD 3 SECONDS

This indicates that the stove is OFF.

### 7 Running Cycle in Automatic Mode:

Heat Output setting.

The stove is lighting.

The stove is ignited, and climbing toward the Heat Output setting.

The stove is stopping.

The stove is in Standby by Room temp. is satisfied.



# Advanced Setting :PROG Mode

### Operation:

- Switching between MAN Mode / PROG Mode (Programmable Mode)
- Operating in PROG Mode

### Conditions:

- Stove Plugged In
- No Thermostat Connected
- Room Sensor Connected

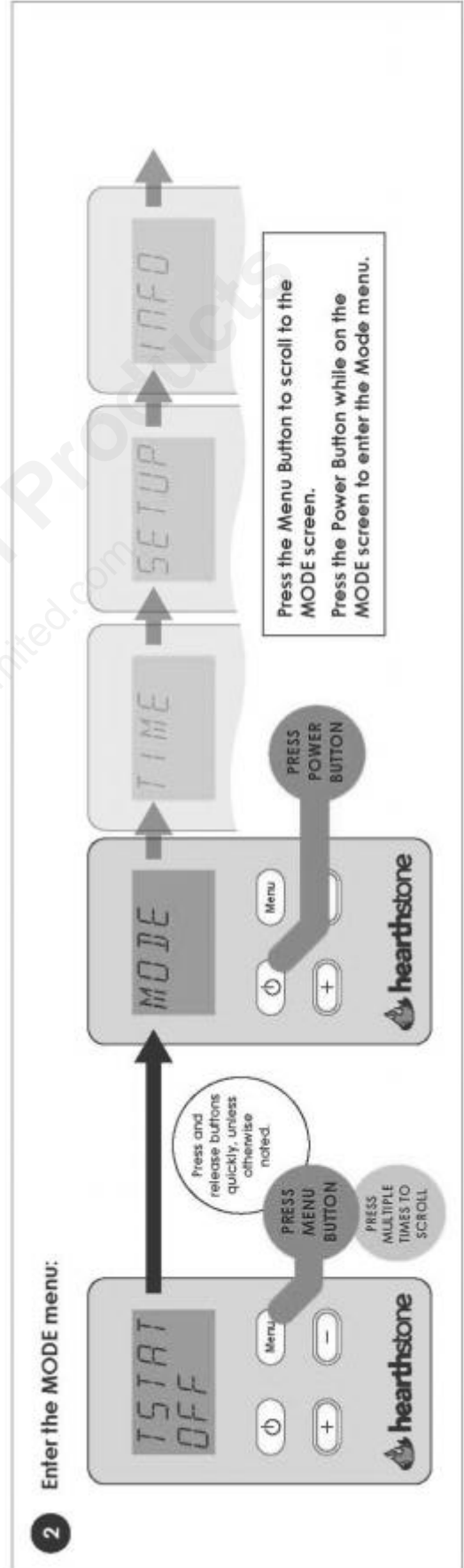
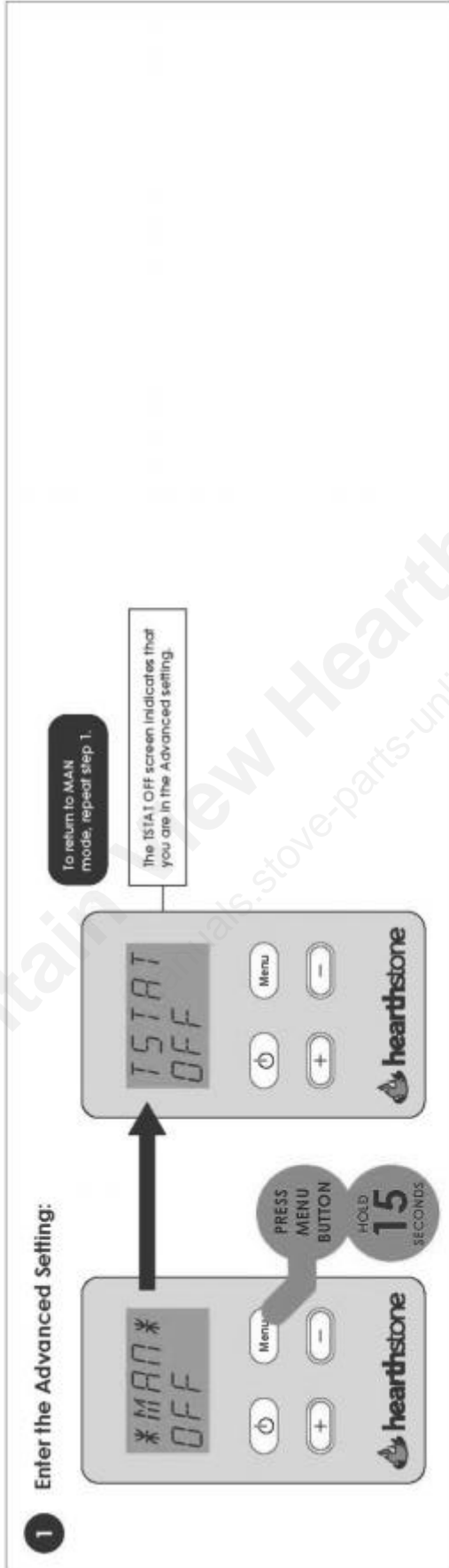

Operation:

- Switching between MAN Mode / PROG Mode (Programmable Mode)
- Operating in PROG Mode

Conditions

- Stove Plugged In
- No Thermostat Connected
- Room Sensor Connected

**3** Selecting PROG Mode:

This screen indicates that you are in the MODE menu.  
Note that the line is blank below the words TSTAT, AUTO, or PROG

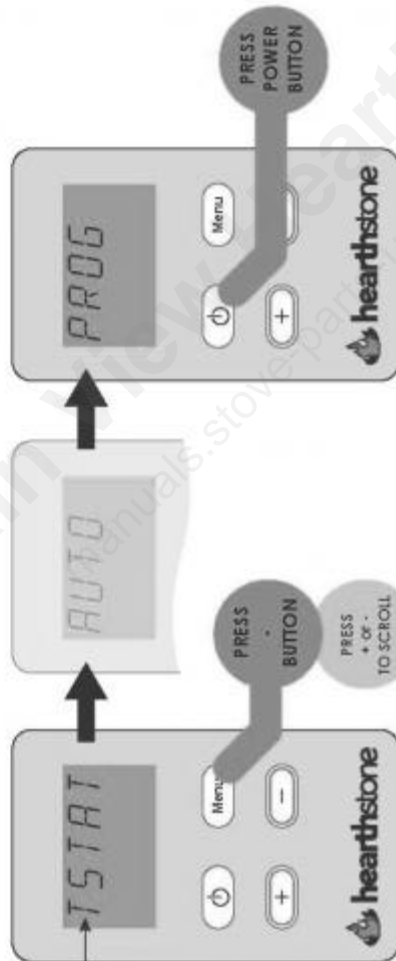

Press the - / + Buttons to scroll through 3 options, as shown.  
Press the Power Button while on the PROG screen to select PROG Mode.

**4** Enter the Time menu:

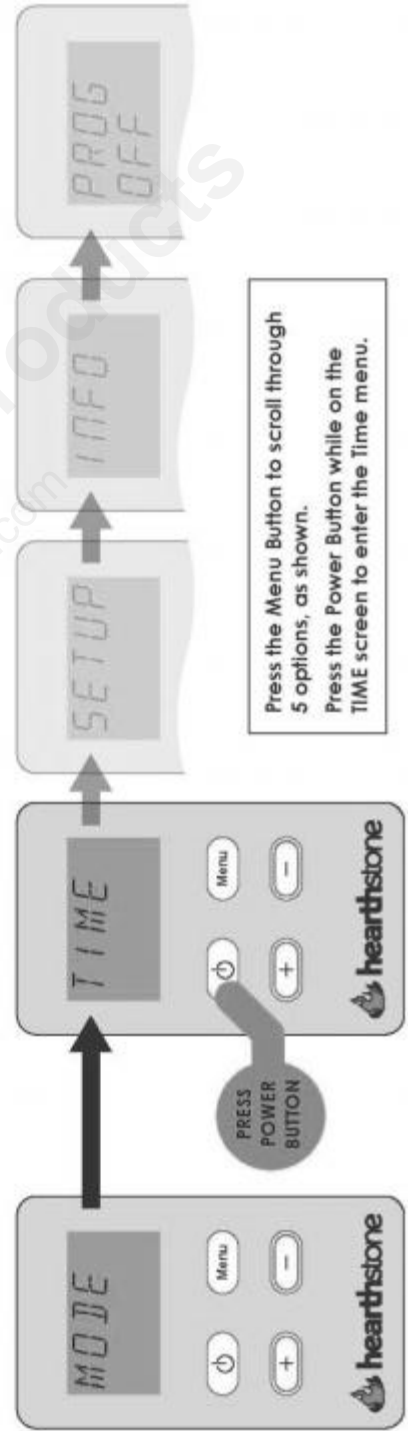

Press the Menu Button to scroll through 5 options, as shown.  
Press the Power Button while on the TIME screen to enter the Time menu.

Operation:

- Switching between MAN Mode / PROG Mode (Programmable Mode)
- Operating in PROG Mode

Conditions

- Stove Plugged In
- No Thermostat Connected
- Room Sensor Connected

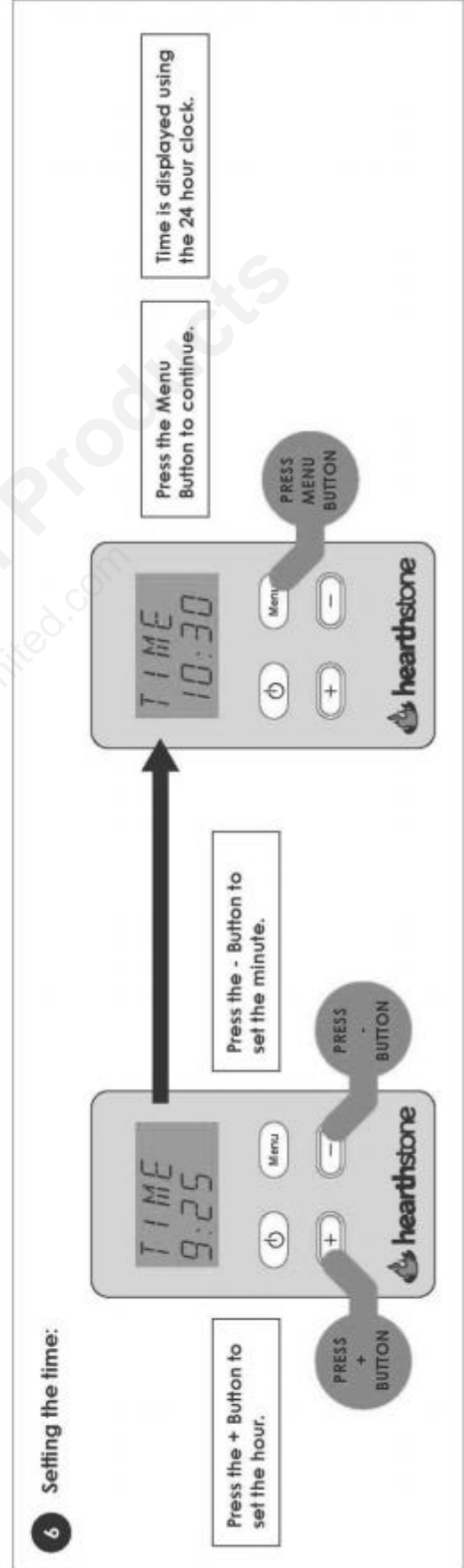
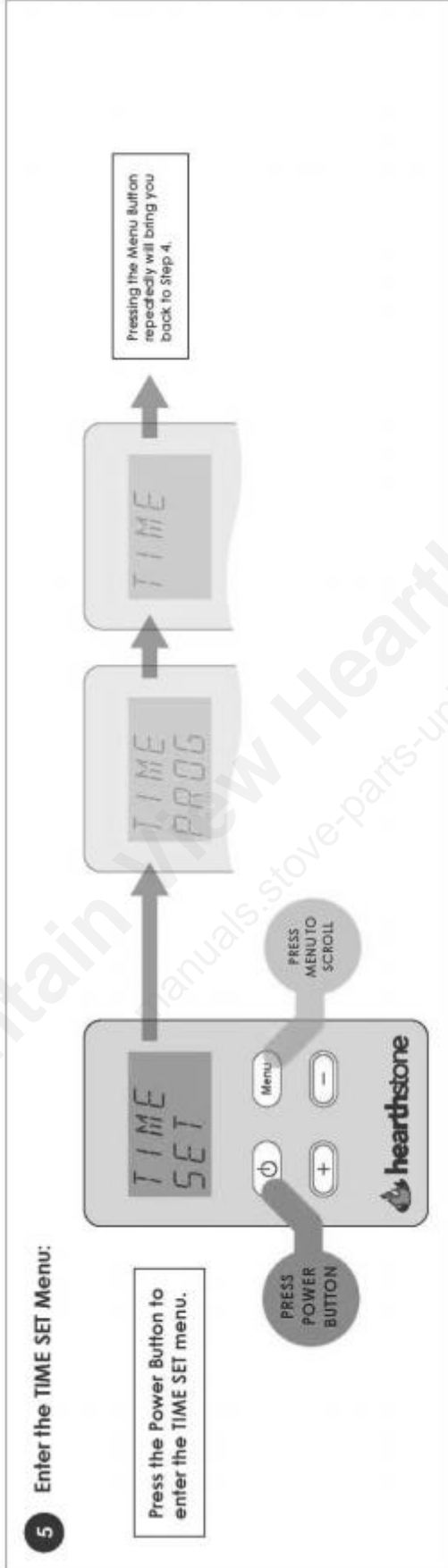

# hearthstone Pellet Stoves

# Advanced Setting :PROG Mode

### Operation:

- Switching between MAN Mode / PROG Mode (Programmable Mode)
- Operating in PROG Mode

### Conditions

- Stove Plugged In
- No Thermostat Connected
- Room Sensor Connected

**7** Setting the day:

Press the + or - Button to select the current day of the month.

Press the Menu Button to continue.

**8** Setting the month:

Press the + or - Button to select the current month.

Press the Menu Button to continue.

**9** Setting the year:

Press the + or - Button to select the current year.

Press the Menu Button to continue.

**10** Confirm the Time / Date settings:

Pressing the Menu Button to confirm that the day is correct.

This indicates the current day of the week.

MO (Monday)
TU (Tuesday)
WE (Wednesday)
TH (Thursday)
FR (Friday)
SA (Saturday)
SU (Sunday)

### Operation:

- Switching between MAN Mode / PROG Mode (Programmable Mode)
- Operating in PROG Mode

### Conditions

- Stove Plugged In
- No Thermostat Connected
- Room Sensor Connected

## 11 Programming Options:

Programming your stove allows you to set 2 different Heat Output levels: one for when you are Home, and one for when you are Away.

Your stove must be set with 2 Home time periods. This would typically mean one Home time period in the morning, and one Home time period in the evening. The Away time periods fall in between the Home time periods.

You must choose one of two options when programming your stove: WEEK or DAY

WEEK - Set one program for the week, every day will run on the same schedule.

DAY - Set a specific program for each day of the week.

## 12 Enter the TIME PROG Menu:

Press the Power Button to enter the TIME PROG menu.

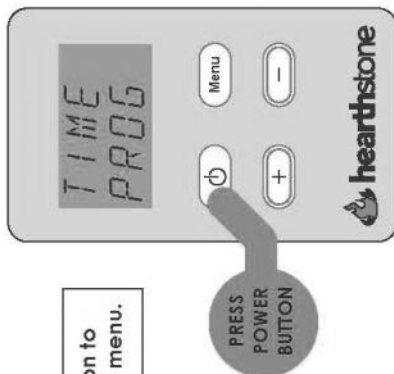

## 13 Setting one program for the week:

Press the Power Button while on the WEEK screen to set one program for all days of the week.

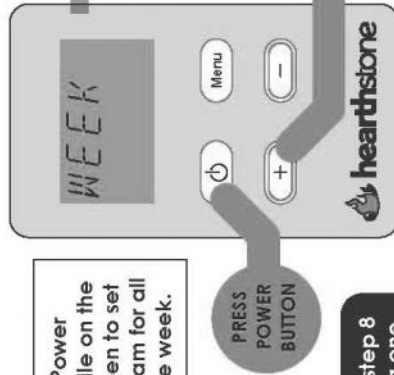

Skip to step 8 if setting one program for the week

## 14 Setting a program for each day of the week:

Press the + Button to scroll to the DAY screen. Press the Power Button to Program the individual days.

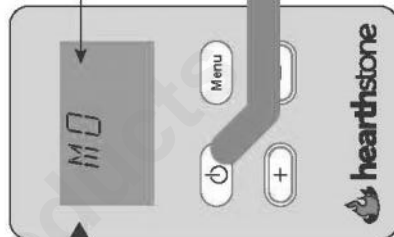
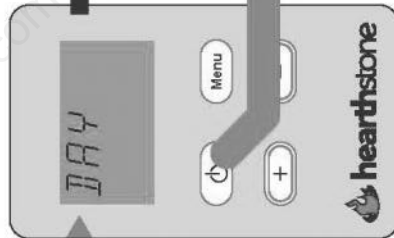

Operation:

- Switching between MAN Mode / PROG Mode (Programmable Mode)
- Operating in PROG Mode

Conditions

- Stove Plugged In
- No Thermostat Connected
- Room Sensor Connected

**15** Setting the first Home time period:

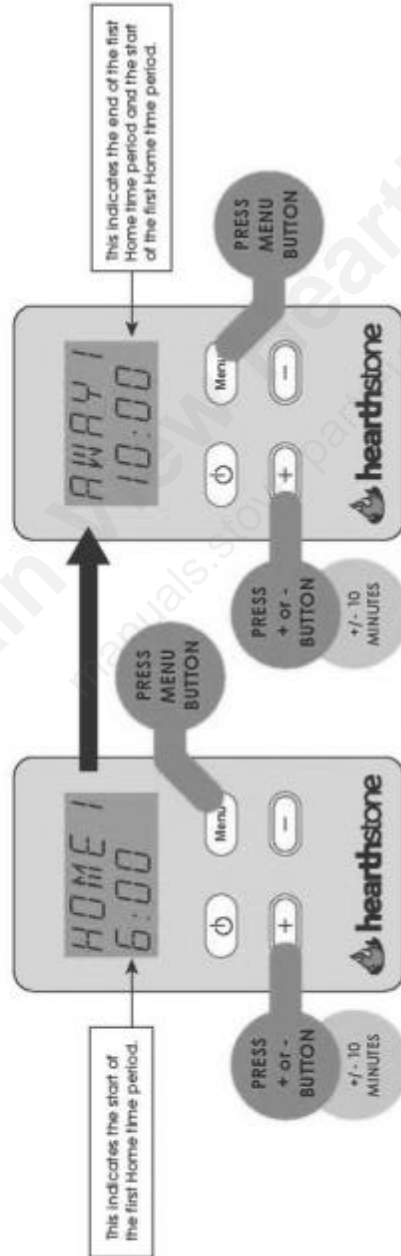

Time is displayed using the 24 hour clock.

This sets the beginning time and end time between which you are usually at home in the morning. In this case, between 6:00am and 10:00am the stove will run at the Home temperature. Before and after this time period, the stove will run at the Away temperature. Both the Home temperature and Away temperatures will be defined after programming.

**16** Setting the second Home time period:

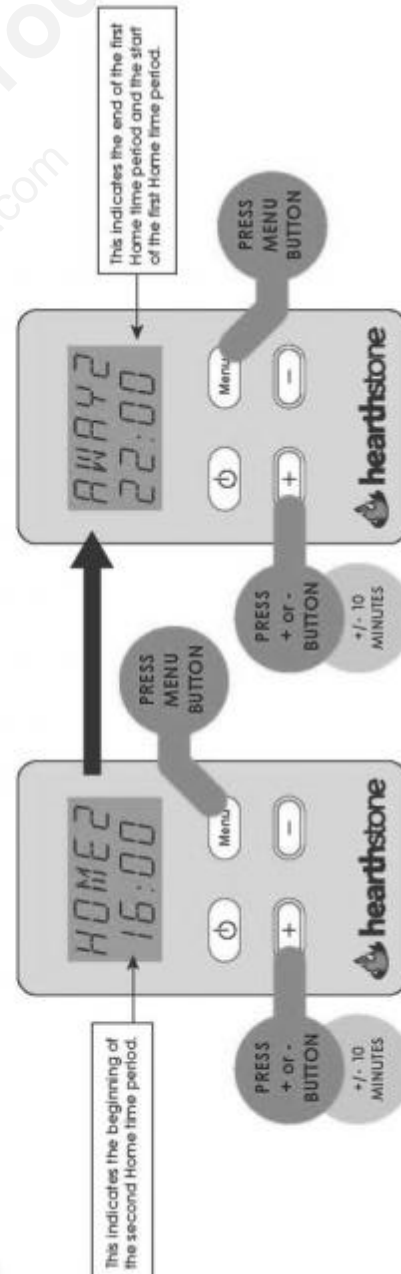

Time is displayed using the 24 hour clock.

This sets the beginning time and end time between which you are usually at home in the evening. In this case, between 4:00pm and 10:00pm the stove will run at the Home temperature. Before and after this time period, the stove will run at the Away temperature. Both the Home temperature and Away temperatures will be defined after programming.

# hearthstone Pellet Stoves

# Advanced Setting :PROG Mode

### Operation:

- Switching between MAN Mode / PROG Mode (Programmable Mode)
- Operating in PROG Mode

### Conditions

- Stove Plugged In
- No Thermostat Connected
- Room Sensor Connected

## 17 Starting the stove with one program for the week: (Only applies if you followed step 13)



Press the Menu Button to return to the PROG OFF screen.  
 Press the Power Button to turn the stove on.  
 Your stove is now programmed, and will begin running.

## 18 Programming each day of the week: (Only applies if you followed step 14)

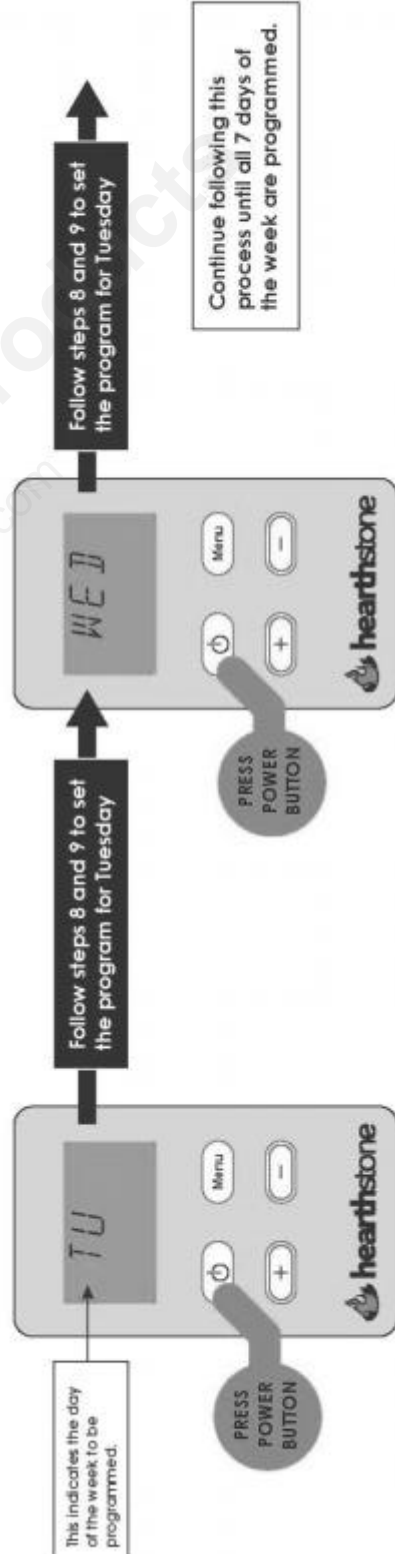

Continue following this process until all 7 days of the week are programmed.

Operation:

- Switching between MAN Mode / PROG Mode (Programmable Mode)
- Operating in PROG Mode

Conditions

- Stove Plugged In
- No Thermostat Connected
- Room Sensor Connected

19 Starting the stove with each day of the week programmed: (Only applies if you followed step 18)

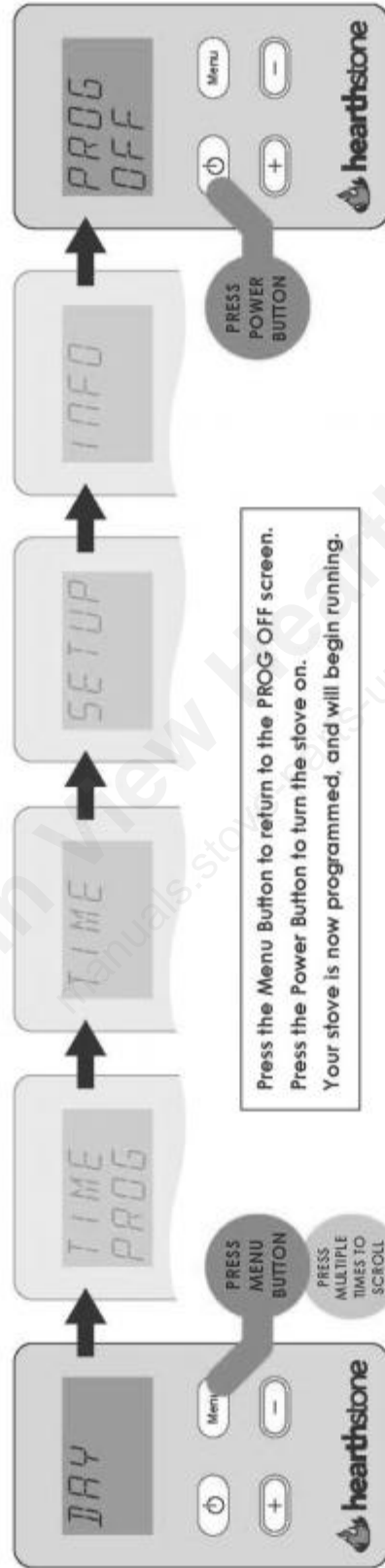

20 Setting the Home temperature:

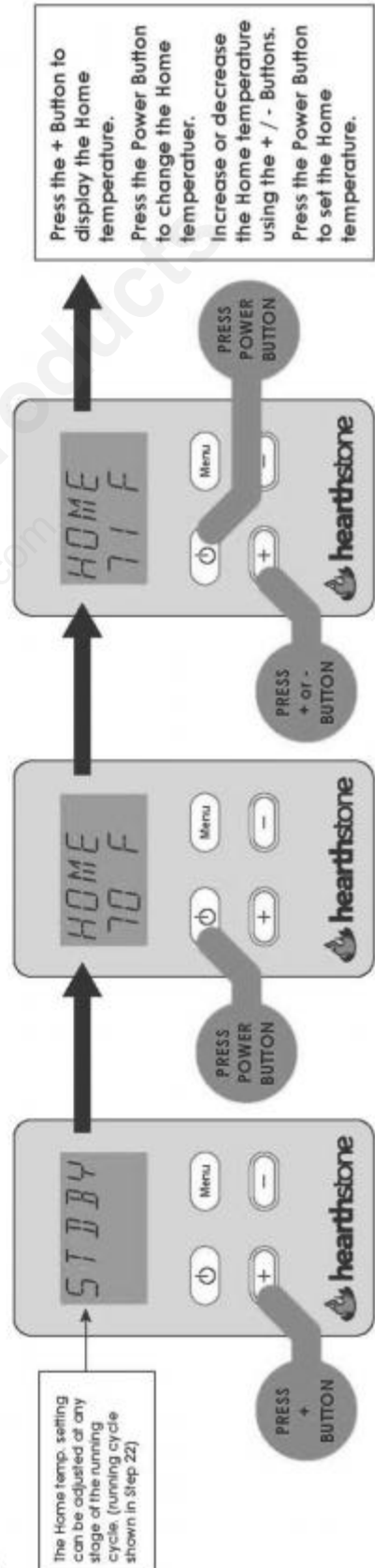

# hearthstone Pellet Stoves

# Advanced Setting :PROG Mode

### Operation:

- Switching between MAN Mode / PROG Mode (Programmable Mode)
- Operating in PROG Mode

### Conditions

- Stove Plugged In
- No Thermostat Connected
- Room Sensor Connected

**21 Setting the Away temperature:**

The Away temp. setting can be adjusted at any stage of the running cycle. (running cycle shown in Step 22)

Press the - Button to display the Away temperature.  
Press the Power Button to change the Away temperature.  
Increase or decrease the Away temperature using the + / - Buttons.  
Press the Power Button to set the Away temperature.

**22 Running Cycle in Programmable Mode:**

The stove is igniting.

The stove is ignited, and climbing toward the Heat Output setting.













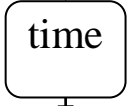

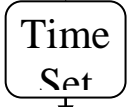

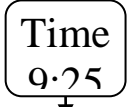



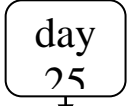

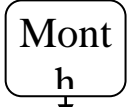
The stove is stopping.

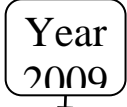
The stove is in Standing by. Room temp. is satisfied.

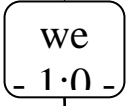
**23 Turning off the stove:**

Press the Power Button HOLD 3 SECONDS. This indicates that the stove is OFF.

## Set the Current Time/Date (Programmable Mode)

	<b>Action</b>
	Step 1: From the main display press  twice.
	Step 2: Press the  button to enter the <b>Time</b> menu.
	Step 3: Press the  button to enter the <b>Time Set</b> area.
	Step 4: Use the  button to set the hour and the  button to set the minutes. Once the time is set press  to continue. <i>Note: 24 hour clock is used on this stove.</i>
	Step 5: Use the  and  buttons to change and set the current day of the month.
	Press  to continue.
	Step 6: Use the  and  buttons to change and set the current month of the year.
	Press  to continue. Step 7: Use the  and  buttons to change and set the current year.
	Press  to continue. Step 8: The current day of the week displays. Press  to confirm the date settings.

# Operation

## Programming the Heating Schedule (Programmable Mode)

The stove can be programmed with two different set temperatures, one home and one away. Each of these set temperatures have two different times they can be switched on. The stove can use the same Home and Away time every day of the week or they can be set differently for every day.



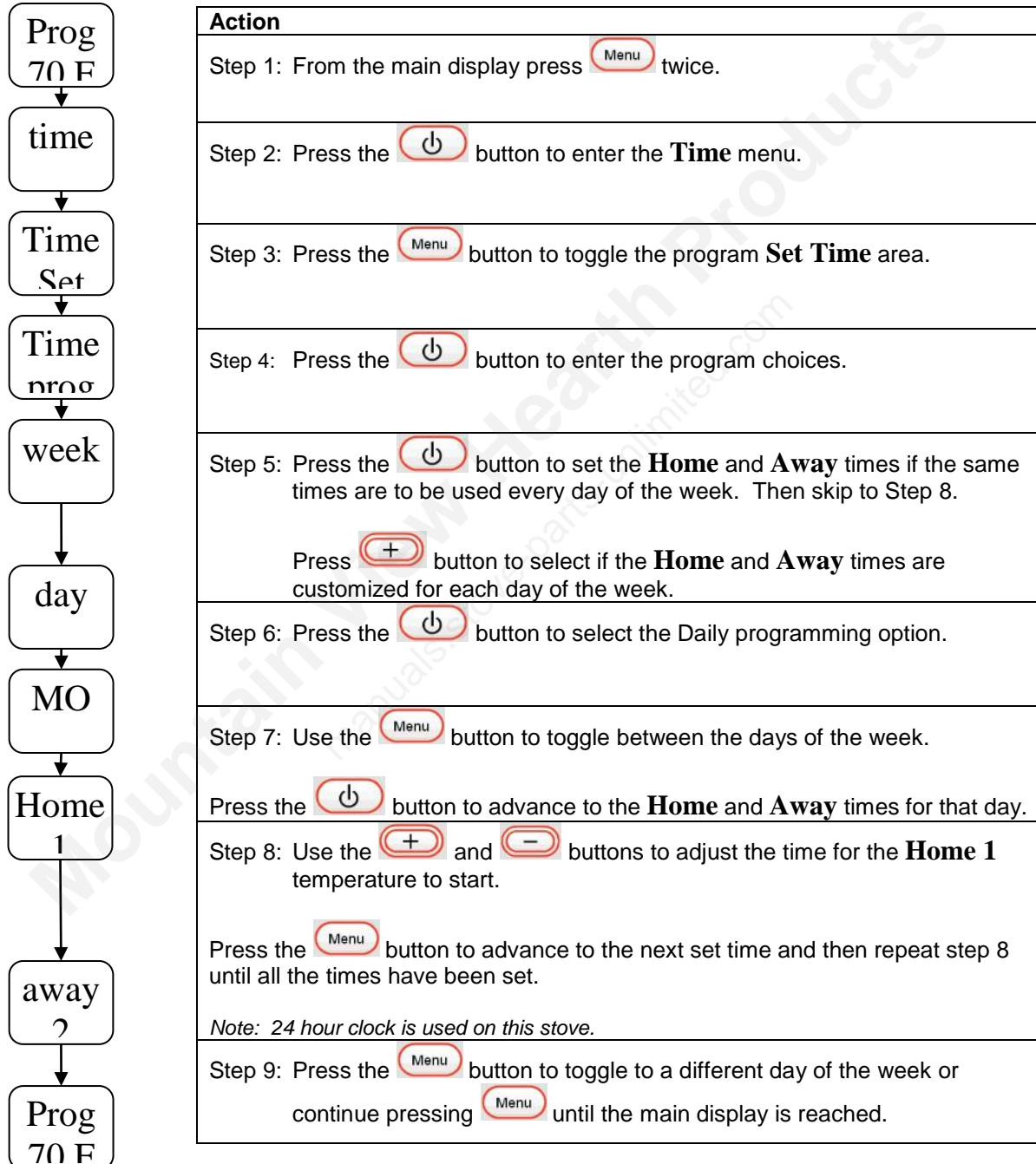



### Setting the Home and Away schedule

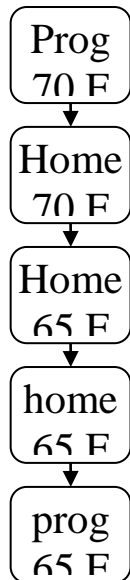

# Operation

## To Adjust Home and Away Temperature (Programmable Mode)



Action
Step 1: From the main display press  to view the <b>Home</b> set temperature or  to view the <b>Away</b> set temperature.
Step 2: Press the  to modify the set temperature.
Step 3: Use the  and  buttons to change the temperatures.
Step 4: Press the  button to confirm the change in the set temperature.

## To Turn On or Off

Press the  button to turn the stove on and off in Programmable mode.

 Note: The stove will not ignite if the set temperature is already achieved.

## Startup Cycle

All of the operation modes use the same startup cycle. Once the startup sequence is initiated, the stove does not require any user intervention. The entire sequence will take between 10 and 20 minutes depending on the starting temperature of the stove and type of pellets.

### Ignition

The igniter, auger, and exhaust fan turn on immediately when the ignition phase is started. The burn pot will partially fill. The amount of filling depends on how full the auger is before the stove is started and the amount of ash and clinkers in the pot. Once the initial amounts of pellets are in the pot, the auger will stop until the pellets ignite. The unit will smoke for a few minutes as the pellets heat, shortly followed by visible flames.

The convection fan will start as soon as the firebox reaches a specific temperature. When ignition is complete, the pellets will begin to feed to maintain the fire.

Once the flame temperature in the firebox has reached a specific temperature, the unit will progress to the start phase.

### Start

The start phase operates until the flame temperature sensor in the firebox reaches the normal operating temperature.

# Operation

## **Shutdown Cycle**

The display will either read **Stop** or **Off** depending on if the unit is shut down manually or from the wall thermostat / room sensor. When the shutdown process starts, the exhaust fan is switched to high.

Once the fire is fully extinguished the control will either display **OFF** or **STANDBY**.

**OFF** will display if the shutdown was manually initiated, or **STANDBY**, if it was turned off by either a wall thermostat or a room sensor.

## **Quick Cleaning Cycle**

Every hour the unit enters a quick cleaning cycle. The cleaning cycle is the same for every operating mode. The cleaning cycle will last several minutes, and then the stove will return to the current operating setting. During the cleaning cycle, the feed rate of the pellets decreases and the exhaust fan speed increases.

## **Shutdown Cleaning Cycle**

After the unit runs for five hours, it enters a more extensive shutdown cleaning cycle. The stove cleans the burn pot by stopping the pellet feed and increasing the exhaust fan speed allowing the fire to extinguish completely. Once the fire is out completely, the stove will enter a normal startup cycle.

## **Power Outages**

The stove does not have backup power to operate during power outages. If the unit is installed with no vertical exhaust venting, it may cause smoke to backup into the room. To minimize the potential for smoke entering the room Hearthstone suggests installing the unit with a minimum of five feet of vertical venting and the use of outside air intake venting.

Once the power is restored, the stove will return to the operational setting active prior to the outage. If ignition is required, the stove will enter a special ignition procedure.

If you live in an area that experiences frequent power outages, you can use an aftermarket backup power supply for this stove, or you can use a generator. Contact your dealer for purchase options and assistance.

## **Frost Setting**





This stove is equipped with a frost setting. To utilize the setting, the room sensor must be connected and the stove must be turned off in the Automatic or Programmable Modes. If the room temperature drops below 42°F, the stove will automatically turn on at its maximum heat output setting, and then turn off when the room reaches 55°F.

 **Note:** This unit is a supplemental heat source. It will not operate without fuel or electricity. Therefore, unattended operation time is limited. Use extreme caution with this feature.

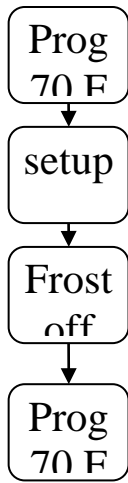
# Operation

## Turning On and Off the Frost Setting







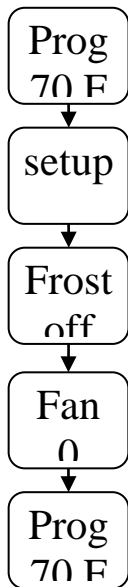

Action
Step 1: From the main display press  three times.
Step 2: Press the  button to enter the <b>setup</b> menu.
Step 3: Press the  button turn the <b>frost</b> setting on and  to turn the <b>frost</b> setting off.
Step 4: Continue pressing  until the main display is reached.

## Adjusting the Exhaust Fan Speed

You should only adjust the exhaust fan speed if the flames have an orange, dirty look and the burn pot has to be cleaned more than once a day. If the fan speed is too high, the fire will extinguish when on the lowest burn rate, and the **No Pellets** error will appear on the display.

### Changing the Exhaust Fan Speed



Action
Step 1: From the main display press  three times.
Step 2: Press the  button to enter the <b>setup</b> menu.
Step 3: Press  twice.
Step 4: Press the  and  buttons to adjust the fan speed faster and slower. The maximum setting is +30 and the minimum is -10.
Step 5: Continue pressing  until the main display is reached.

# Operation

## *Ash Disposal*

Disposal of Ashes – Ashes should be placed in a steel container with a tight fitting lid. Other waste shall not be placed in this container. The closed container of ashes should be placed on a noncombustible floor or on the ground, well away from all combustible materials, pending final disposal. If the ashes are disposed of by burial in soil or otherwise locally dispersed, they should be retained in the closed container until all cinders have been thoroughly cooled. Ensure you firmly seat the ash pan when ash removal is completed.

 **Note: Do not open the ash pan or front door until the stove is completely cooled.**

Mountain View Hearth Products  
manuals.stove-parts-unlimited.com

# Maintenance

- 🔥 **ALWAYS WORK ON A COOL STOVE!**
- 🔥 **ALWAYS DISCONNECT THE POWER BEFORE PERFORMING ANY MAINTENANCE.**
- 🔥 **WARNING: DO NOT USE ABRASIVE CLEANERS ON THE DOOR GLASS. SCRATCHING THE CERAMIC GLASS WILL COMPROMISE ITS STRENGTH.**
- 🔥 **WARNING: DO NOT CLEAN THE GLASS WHILE THE STOVE IS BURNING, OR WHEN THE GLASS IS HOT.**

Proper maintenance is essential to clean and reliable performance of your Hearthstone Stove.

Your Heritage Pellet stove requires routine maintenance and care. Ensure your stove is cool to the touch and unplugged during cleaning or service. Have qualified service personnel inspect the unit and venting once a year to ensure that they are clean, free of obstruction, safe, and in good working order. If service is required, only qualified service personnel should perform it.

- 🔥 **WARNING: DO NOT SUBSTITUTE MATERIALS. FOR REPLACEMENT PARTS, OR FOR INFORMATION ABOUT PARTS OR SERVICE, CONTACT YOUR LOCAL HEARTHSTONE DEALER.**
- 🔥 **NOTE: TURN THE UNIT OFF. ALLOW THE UNIT TO COOL. DO NOT OPEN THE ASH PAN OR FRONT DOOR UNTIL THE STOVE IS COMPLETELY COOLED.**

## Level 1 - Daily

### Clean burn pot

1. Open front door.
2. Check for buildup, and remove clinkers if present.
3. Remove burn pot and sweep ashes into ash pan if necessary.
4. Clean and check burn pot for wear.

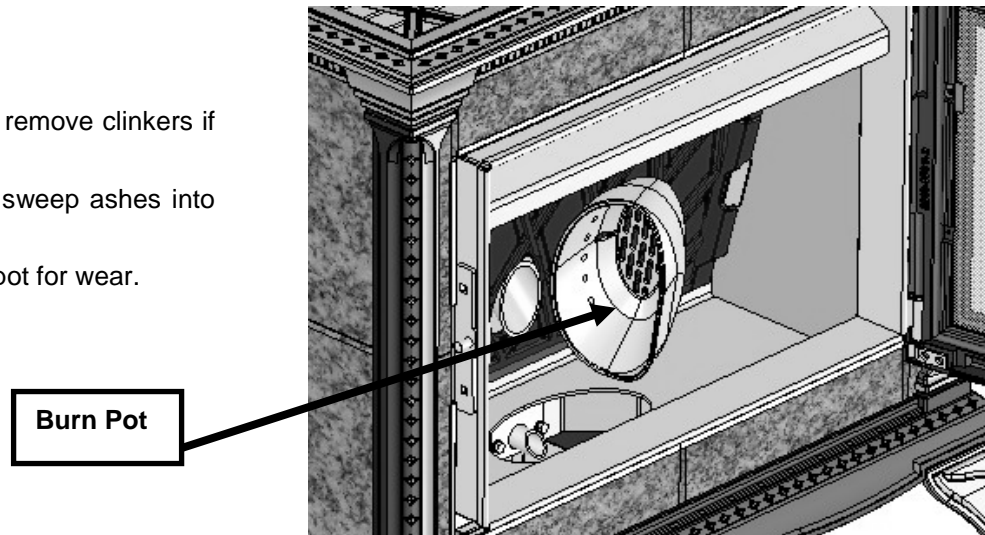

### Clean heat exchanger

1. Exercise both rakes using provided maintenance tool.

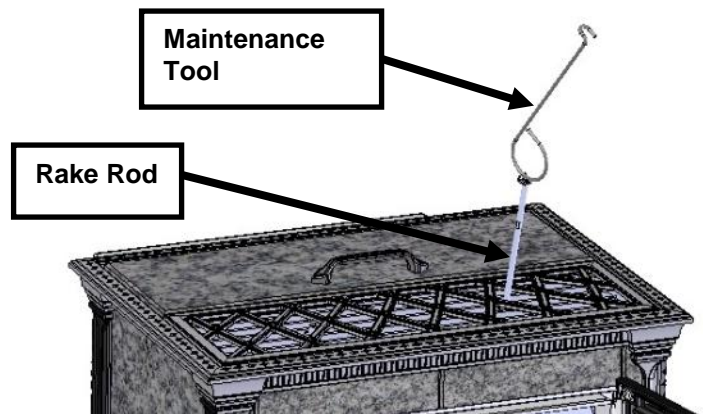

# Maintenance

## Level 2 – Weekly or as Needed

### Remove ash from firebox

1. Lift burn pot, sweep ashes into ash pan or use an ash vacuum.

**WARNING! USE OF A REGULAR VACUUM MAY CAUSE A FIRE.**

### Remove ash from ash pan

1. Remove drawer, deposit ashes in proper metal receptacle with closable lid.

### Clean glass

**DO NOT USE ABRASIVE CLEANERS ON THE GLASS.**

1. Use glass cleaner and soft cloth, or use pellet ash and a water moistened cloth (rub lightly).

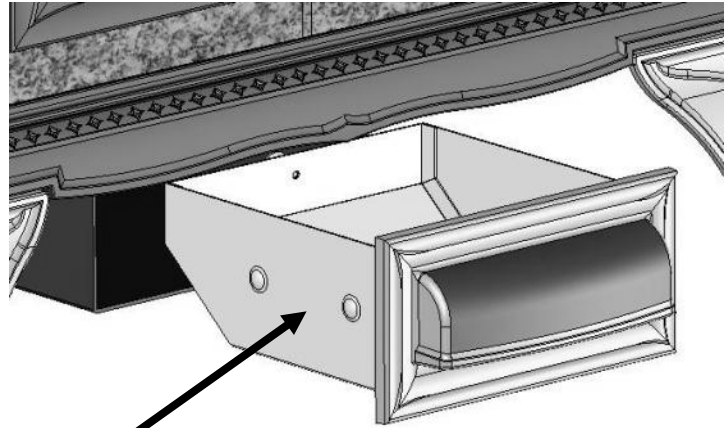

Ash Pan

## Level 3 – at Least Monthly

### Clean Hopper & Auger

1. Remove auger access plate inside hopper (8mm wrench or socket).
2. Vacuum any fines in hopper and auger trough.
3. Replace access plate.

Auger Access Plate

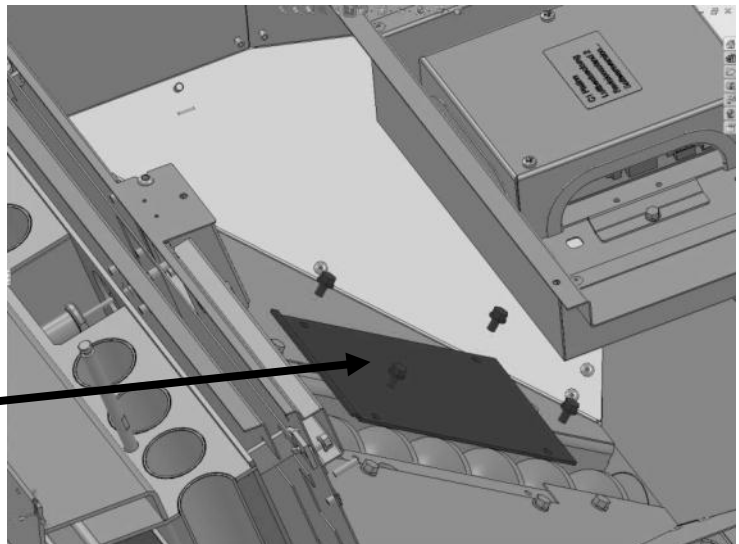

# Maintenance

## Level 4 – at Least Yearly or Every Ton of Pellets

### Clean Hopper, Auger & Exterior of Pellet Engine

1. Remove hopper door – vacuum hopper and auger inlet.
2. Remove top casting and grille assembly – vacuum all surfaces.
3. Remove both side panels (lift using tool provided), remove rear panel – vacuum all surfaces

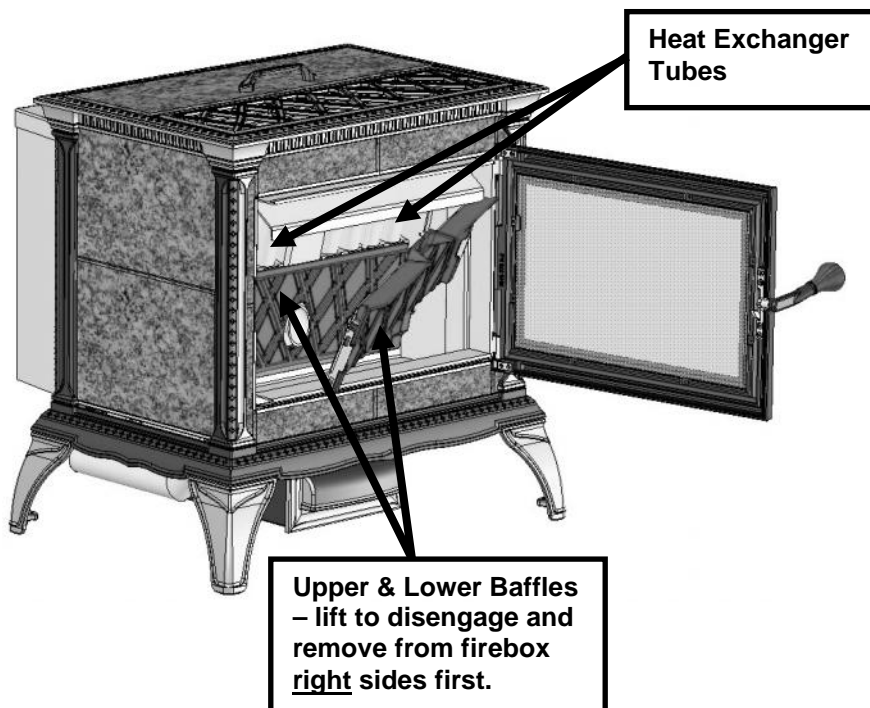
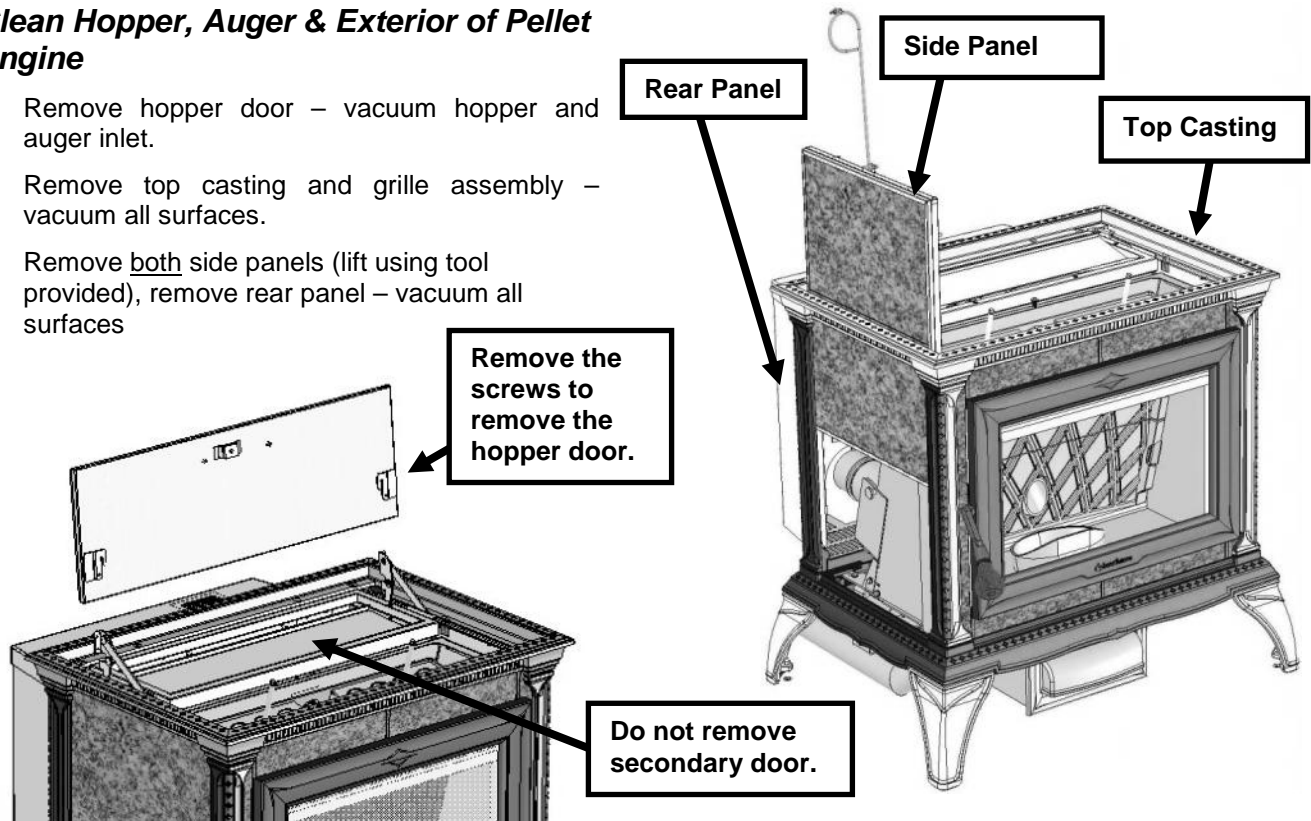

### Clean Baffles & Heat Exchanger

1. Remove and clean firebox baffles. Inspect for burn through or cracking – replace as required.
2. Exercise rakes, vacuum all accessible surfaces and spaces
3. Clean convection fan impeller cage with a soft brush – vacuum as necessary.
4. You can use high temperature stove paint inside the firebox after cleaning to prevent rust during the non-heating season.

# Maintenance

## Clean Convection Fan

1. Remove the screen panel (4 screws) – vacuum screen and inside housing, remove any build up from fan blades with soft bristle brush.

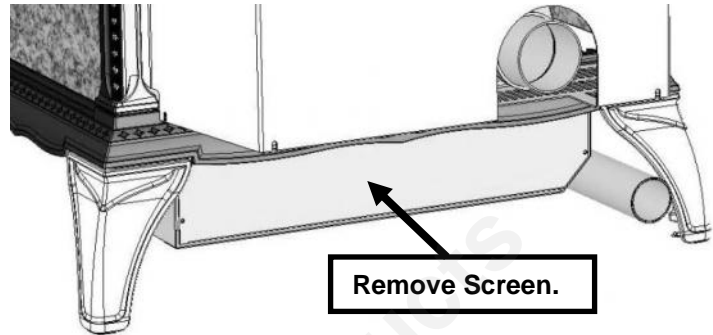

## Clean Manifold

1. Remove both left and right heat exchanger access panels – vacuum inside the manifold.

## Clean Exhaust Fan

2. With the access plates removed – remove any build up from exhaust fan blades with soft bristle brush.

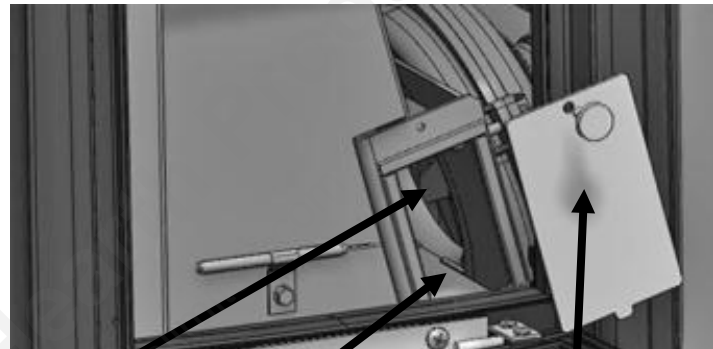

Exhaust Fan  
Blades

Vacuum inside  
on both sides of  
manifold

Plate with  
thumbscrew (x2)

## Inspect Gaskets

1. Use the Dollar bill test and check the door and ash pan gaskets for wear, replace as necessary.
  - a. Open the door, or ash pan, place a dollar bill over the gasket at various locations, close the door and pull the bill out.
  - b. If there is little or no resistance, adjust the latch catch or replace the gasket.

## Inspect Venting

**Soot and Flyash: Formation and Need for Removal** - The products of combustion will contain small particles of flyash. The flyash will collect in the exhaust venting system and restrict the flow of the flue gases. Incomplete combustion, such as occurs during startup, shutdown, or incorrect operation of the room heater will lead to some soot formation which will collect in the exhaust venting system. The exhaust venting system should be inspected at least once every year to determine if cleaning is necessary.

1. Disassemble venting and check for ash and soot accumulation – clean as necessary.
2. Assemble flue connections - seal all connections after cleaning. Follow vent manufacturer's guidelines.

# Maintenance

## As Needed

### External Cleaning

**🔥 WARNING: DO NOT CLEAN THE UNIT WHEN HOT OR WHEN ANY SIGN OF COMBUSTION IS PRESENT.**

External Cleaning - The unit should receive regular cleaning on, under, and around the stove to prevent the buildup of dust and lint. Clean the exterior painted or enameled surfaces of the unit using soap, water, and a soft cloth. **Do not** use abrasive or chemical cleaners. Take care not to scratch the glass or enamel finish (if so equipped) when cleaning the unit. We do not recommend the use of chemical wax based cleaners or polishes due to the potential for discoloration of the castings or enamel when the residues of the cleaners or polishes are subject to heat. Excessive buildup of dust, spider webs, or room air contamination may cause odors when the stove is hot.

### Stone Cleaning

Occasional cleaning is all that is necessary to maintain the natural beauty of your stove's soapstone/sandstone. Clean the soapstone only with water or any non-abrasive cleaner and a soft cloth. To remove stains and smudges from sandstone, buff lightly with 200 or 220 grit sandpaper. Wipe dust from the stone with a clean cloth. Do not use chemical agents to wash the stone; do not use waxes or any polishing agents on the stone. Soapstone and sandstone are porous and will absorb most liquids, which can leave a stain, change the appearance, or result in odd odors when warm. If you accidentally break a stone, contact your dealer for a replacement.

### Grill Height Adjustment

The convection air grill height is adjustable if necessary. The grill rests on three screws – tightening, or loosening the screws changes the grill's height and fit.

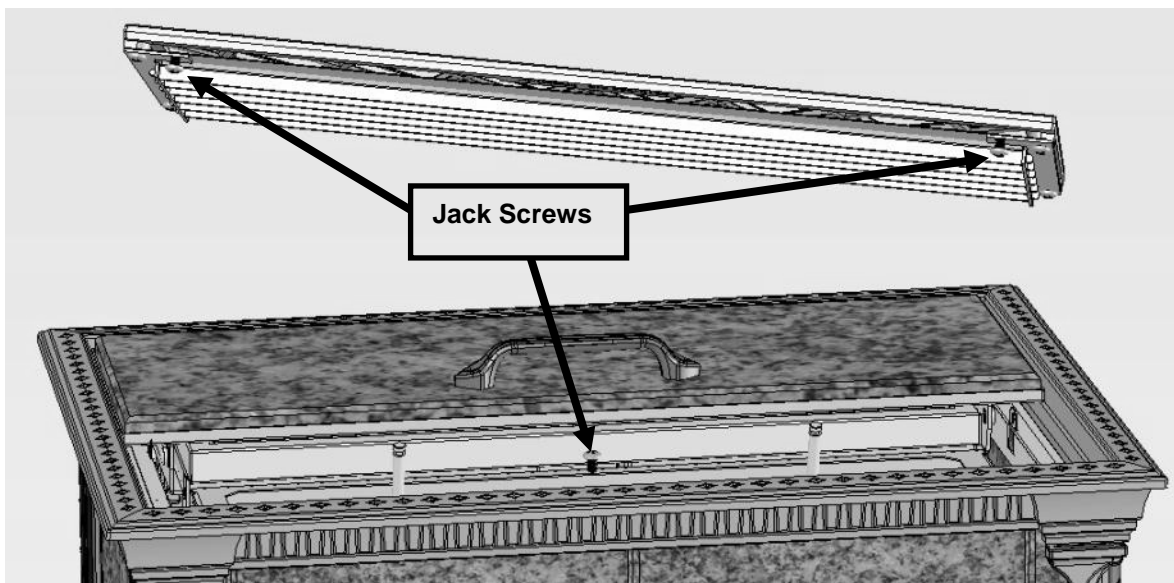

# Maintenance

## Glass Replacement Procedures

**WARNING: DO NOT OPERATE THIS APPLIANCE WITH THE GLASS PANEL REMOVED, CRACKED, OR BROKEN. DO NOT SUBJECT THE DOOR TO ABUSE, SUCH AS STRIKING OR SLAMMING SHUT. ONLY A QUALIFIED SERVICE PERSON SHOULD REPLACE THE GLASS PANEL.**

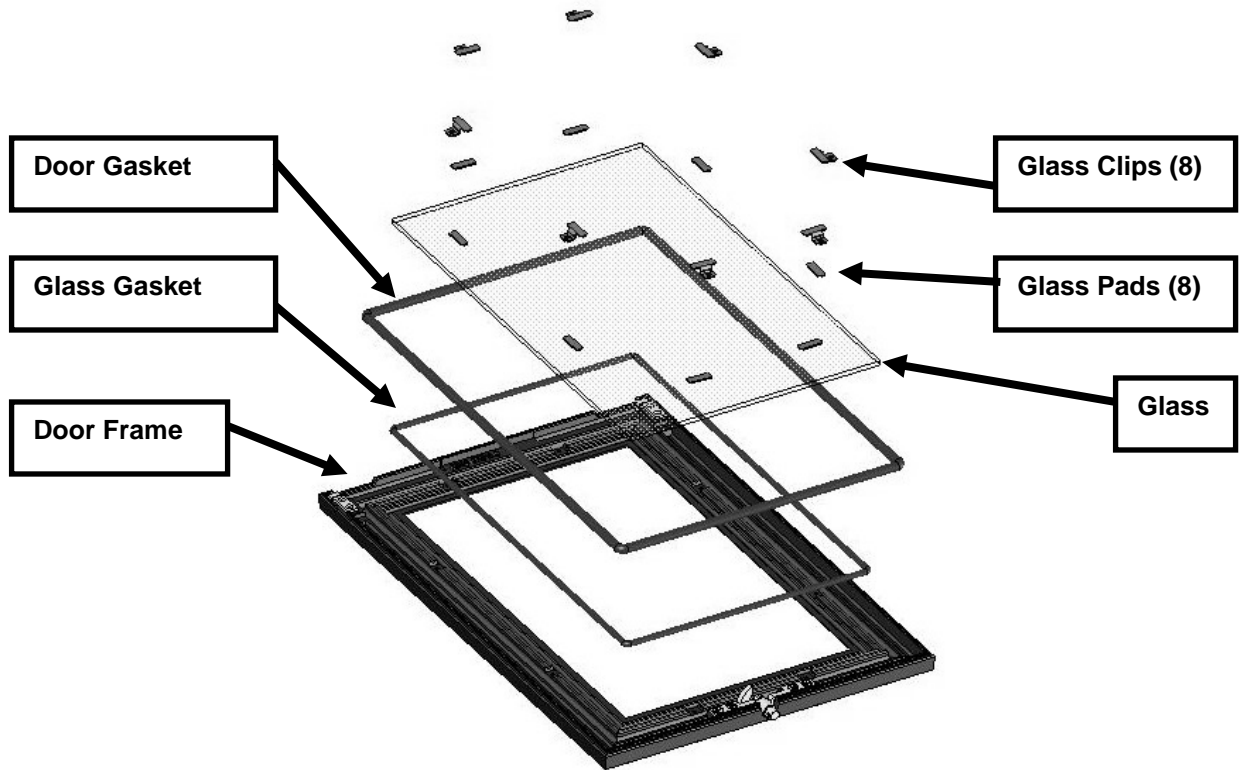

Figure 1: Front Door assembly

1. Follow the instructions included with the replacement glass kit.
2. Remove the door.
3. Remove the screws from the glass clips (use penetrating oil if necessary) – lift the clips off the glass. Set aside for reinstallation or use the new clips, and pads provided with the replacement glass kit.
4. Carefully lift the damaged glass out of the door and discard.
5. Remove any remaining glass and old gasket material.
6. Clean the screw holes and place a small amount of anti-seize compound in each one.
7. Place the gasketed new glass onto the door. **Ensure sticker is on the exterior face of the glass.**
8. **Important! Center the glass** and ensure that the edges of the glass are parallel with the edges of the opening.
9. Check glass position again (centered, and parallel), then screw the glass retainer clips on the door using a crisscross pattern. Tighten the screws no more than 1/8<sup>th</sup> of a turn after they seat. The glass will break at this point if not positioned correctly.
10. Apply a light film of anti-seize lubricant on the door's hinge pins if needed.
11. Install the door.
12. After 5 or 6 fires, check the glass clip screws, and retighten if necessary.

**Required Glass Kit:** Part Number: 90-58900 (Glass with gasket applied). Use only 5mm Ceramic IR, or Neoceram IR glass. Contact your Hearthstone dealer.

# Troubleshooting

Most errors and issues are due to a lack of required maintenance, or cleaning. Using the instructions on the following pages should resolve most issues. If an operation error is detected, the user interface flashes, and displays a message. If the message prompts the unit to shut down, a >I/O< notice will follow the text of the message. To acknowledge a message, press and hold the power button for approximately 5 seconds, if the process associated with the message is complete, the stove will return to OFF Mode. At this point, normal operation may begin again if all conditions are satisfied.

## Display Messages:

Display	Problem	Possible Causes	Solution
No Pellets - (code F04)	Temperature in firebox unexpectedly dropped, or set point never reached	Pellet fuel level too low	Refill hopper
		Inferior, or wet pellets	Clean out hopper, and auger – refill with premium, dry pellets
		Auger jammed	Clean the auger. Follow the procedure in Maintenance section of this manual.
		Hopper door open	Close hopper door
No Ignition - (code F01)	Required pellet ignition temperature not achieved during startup – firebox temperature too low	Dirty Stove	Preform a Level 4 Cleaning (see page 28)
		Inferior/wet pellets	Consult your Hearthstone dealer for a recommended pellet type and storage
		Auger clogged with fines	Clean auger
		Burn pot full of ash or clinkers	Clean burn pot
		Ash pan full and ashes contacting bottom of burn pot	Empty ash pan.
		Auger was completely empty and did not refill fast enough	Reset and start again. When the auger is empty, it may be necessary to add 1 cup of pellets to the burn pot prior to starting the unit.
		Front door, or ash pan open	Check both and verify they are closed completely, and sealing properly
		Hopper door is open	Close hopper door
		Blocked exhaust venting	Clean venting – also check heat exchanger for flyash, or soot buildup
		Restricted air intake, or outside air intake required.	Inspect ducting. Remove blockage. Install outside air intake
		Burn pot installed backwards	Install burn pot so ignitor hole is towards the rear of the stove
Ignitor failed	Check wiring. Replace igniter		
STb Initiated - (code F03)	Firebox/heat exchanger temperature too high	C-Fan (convection fan) setting above +5	Reset program. Do not adjust C-Fan setting.
		Convection fan not working	Service the unit.
		Convection fan clogged	Clean the convection fan. Follow the procedure in the Maintenance section of this manual.
		Top grill blocked	Remove any blockage from top of stove. Check for lint or hair on screen.

Display	Problem	Possible Causes	Solution
Flame Sensor – (code F06)	Temp sensor in firebox is malfunctioning	Flame sensor not working	Reset the unit using the power switch and contact your dealer if the problem persists.
Room Sensor – (code F07)	Communication between room sensor and stove interrupted	Room sensor unplugged	Check the rear room sensor connection at the rear of the stove or the connection on the inside of the room sensor.
		Sensor malfunction	Replace room sensor.
Too Little Air – (code F09)	Not enough air flow through firebox (monitored by sensors in inlet pipe)	The front door or ash pan open	Check both and verify that they are closed completely
		Inlet or exhaust venting blocked.	Inspect all venting. Verify there is no blockage. Clean Venting, Check stove.
		Excessive interior negative pressure	Install outside air inlet.
		Door gasket worn or missing	Check gasket using the dollar bill test outlined in this manual (see page 29). Replace gasket if necessary
		Exhaust blower clogged	Clean the blower. Follow the procedure in the Maintenance section of this manual.
		Dirty stove	Perform a Level 4 Cleaning (see page 28)
		Poor air flow, or exhaust fan speed too slow	Replace 3" exhaust venting with 4" If everything checks, out and problem persists – increase exhaust fan speed
Cap Open	Hopper sensor not engaged.  Note: The cap open error causes the auger to stop and will starve the stove for fuel if not addressed quickly.	Hopper open	Close hopper door
		Pellets on gasket seal	Clean off seal
		Hopper overfilled	Remove some pellets
		Hopper door not sitting correctly on hinges.	Check that the slots on the hopper door are fully engaged and the set screws are tight
		Sensor magnet dislodged.	Remount magnet on bottom of hopper door.
		Sensor malfunction	Replace sensor
Flue Gas Fan Faulty – (code F05)	The signal has stopped from the exhaust blower	Exhaust blower not working	Service the unit.
		Exhaust blower sensor wire disconnected	Service the unit.
		Exhaust blower clogged	Clean the exhaust blower. Follow procedure Maintenance section of this manual. Blades must move freely.

**General Issues:**

<b>Problem</b>	<b>Possible Causes</b>	<b>Solution</b>
Burn pot is overflowing.	Burn pot needs cleaning	Remove excess ashes, clinkers, and live coals from burn pot
	Ignition did not occur	Clean burn pot
		Ensure burn pot installed with ignitor hole towards rear
	Ignitor failure. Service the unit.	
Dirty stove	Preform a Level 4 Cleaning (see page 28)	
Stove feeding pellets without ignition	Turn off stove. Dump pellets into ash pan. Restart stove.	
Burn pot clogs too quickly or pellets are partially burned (less than 24 hours of operation)	Poor quality or wet pellets	Consult your Hearthstone dealer for a recommended pellet type and storage
	Too much restriction in the venting	Clean intake and exhaust venting
		Increase the exhaust fan speed
		Replace 3" exhaust venting with 4"
	Excessive negative pressure in the house	Install an outside air intake.
	Burn pot is not seated correctly	Burn pot must be in direct contact with the steel surface of firebox around the perimeter of the pot. Clean floor of firebox.
	Ash pan too full and ashes contacting bottom of burn pot	Empty ash pan.
Exhaust blower clogged	Clean exhaust blower. Follow procedure in the Maintenance section of this manual.	
Fire has gone out	Room temperature satisfied (display reads STOP)	Normal operation
	Stove in a cleaning cycle (display reads CLEAN)	Normal operation
	No, or low fuel in hopper	Fill hopper with fuel
	Too much restriction in venting	Clean intake and exhaust venting
		Increase exhaust fan speed
		Replace 3" exhaust venting with 4"
	Hopper opened too long	Decrease fill time. When the hopper is open the auger does not turn, which starves the fire of fuel
Auger motor or exhaust fan failure	Service the unit.	
No power to the stove	Check circuit - supply power to the unit	
Visible, or the smell of smoke	Excessive negative pressure in the house is causing exhaust vent leak, or door gasket not sealing properly	Seal venting with 500 <sup>o</sup> F RTV silicone.
		Install outside air intake
		Replace gasket
	Power outage	Normal operation. Will dissipate when remaining pellets in hopper are consumed Contact you Hearthstone Dealer for battery back-up options

<b>Problem</b>	<b>Possible Causes</b>	<b>Solution</b>
Low heat output	Excessive soot on heat exchanger	Follow procedure in the Maintenance section of this manual.
	Poor quality, or wet pellets	Consult your Hearthstone dealer for a recommended pellet type and storage
	Dirty stove	Perform a Level 4 Cleaning (see page 28)
Display not working	Stove unplugged, or electrical circuit is off	Ensure stove is plugged in to an active circuit
	Power outage	Contact your Hearthstone Dealer for battery back-up options
	Connection between mother board and display not working	Check fuse on back of stove
		Check wire connections between mother board and display
Display malfunction	Replace display	

# Replacement Parts & Optional Accessories List

PART NUMBER:	DESCRIPTION:	PART NUMBER:	DESCRIPTION:
<b>STONE:</b>		<b>GASKETS:</b>	
1941-210	HOPPER DOOR SOAPSTONE	3110-056	GASKET: ROPE, 1/4", BLK, AD
1941-215	FRONT VERTICAL SOAPSTONE	3110-057	GASKET: ROPE, 3/8", AD, NON-CORE
1941-220	FRONT HORIZONTAL SOAPSTONE	3120-021	GASKET: GLASS CLIP
1941-225	SIDE POLISHED SOAPSTONE	3160-070	GASKET: TAPE 5/8" X 1/4"
		3160-080	GASKET: TAPE, 3/4"x1/16", AD
<b>CASTINGS:*</b>		3160-390	GASKET: FEEDER TUBE
2010-910	FOOT	3160-391	GASKET: CONTROL BOARD
2010-915	ASH DOOR	3160-392	GASKET: 3/8" X 1/8" FLAT KNIT BLK 1/4" AD SP
2010-925	BOTTOM	3160-396	GASKET: MTR HOUSING KNOCKOUT
2010-930	CORNER SIDE LEG	3160-397	GASKET: INLET TUBE
2010-955	FRONT DOOR HANDLE		
2010-997	HOPPER DOOR HANDLE	<b>MISC:</b>	
2310-990	TOP	3120-220	UPPER BAFFLE CERAMIC HEATSHIELD
2010-995	TOP GRILL	3120-221	LOWER BAFFLE CERAMIC HEATSHIELD
2010-970	FRONT DOOR	3200-101	SATIN BLACK HIGH TEMP PAINT
2310-655	ASH PAN DOOR HANDLE	3900-184	WOODEN KNOB
2910-000	BURN POT	4700-0795	MAGNET
2910-005	BAFFLE: UPPER	5090-080	SERVICE TOOL
2910-010	BAFFLE: LOWER	5210-3080	ROD: HEAT EXCHANGER CLEANING
		5240-145	ASH PAN CATCH SPRING
<b>STEEL:</b>		5240-146	ASH PAN CATCH KNOB
5000-095	BEARING: SINTERED, 16MM ID	5532-012	PALLET MOUNTING CLIP
5000-096	BEARING: SINTERED, 10MM ID	5909-050	FLAME SENSOR
5090-011	PAN: ASH	6400-40465	OWNER'S MANUAL
5090-016	FRAME: OUTER ASH BOX	7000-037	WIRE HARNESS
5090-069	SCREEN: OUTLET GRILL	7211-951	CONVECTION FAN ASSY
5090-070	LOUVER: CIRCULATION AIR	7211-967	EXHAUST FAN MOTOR
5090-071	SECONDARY HOPPER HINGE PIN	7211-970	AUGER MOTOR
5090-072	LEFT HOPPER DOOR HINGE	7300-000	MOTHER BOARD
5090-073	RIGHT HOPPER DOOR HINGE	7300-005	AIR FLOW SENSOR
5090-074	HOPPER EXTENSION	7300-010	CONTROL BOARD
5090-075	HOPPER DOOR	7300-015	IGNITER ELEMENT
5090-060	FRONT DOOR FRAME	7300-020	HOPPER SAFETY SENSOR
5090-078	DOOR: SECONDARY HOPPER	7300-025	TEMP SAFETY LIMIT SWITCH
5090-076	FRONT TOP SUPPORT	7300-030	FLAME SENSOR THERMOCOUPLE
5090-077	REAR TOP SUPPORT		
5090-017	RETAINER: FRONT OUTER STONE	<b>KITS:</b>	
5090-018	RETAINER: FRONT INNER STONE	90-56925	WIRED ROOM SENSOR
5090-019	FRAME: FRONT STONE	90-58900	GLASS KIT
5090-021	FRAME: INNER SIDE STONE	90-70900	HOPPER DOOR SUPPORT KIT
5090-022	FRAME: OUTER SIDE STONE	90-73900	FRONT DOOR HANDLE KIT
5090-060	FRAME: DOOR, FRONT	90-76900	LOWER BAFFLE KIT
5090-061	HOLDER: LATCH: FRONT DOOR	90-76901	UPPER BAFFLE KIT
5090-063	LATCH: FRONT DOOR		
5090-064	HINGE: FRONT DOOR		
5909-020	SIDE COVER		
5909-061	AIR INLET PIPE		
5909-070	EXHAUST FAN HOUSING		
5909-080	AIR WASH		
5909-095	IGNITER FERRULE		
5909-220	HOPPER: CABLE CHANNEL		

\* Part numbers: use 2010 for Matte, 2020 for Brown Majolica.

Heritage Pellet Stove Model 8091.

Manufactured and Warranted by:

Hearthstone Quality Home Heating Products, Inc.  
317 Stafford Ave,  
Morrisville, VT 05661  
www.hearthstonestoves.com

# Safety Label

CONTACT YOUR LOCAL BUILDING RESTRICTIONS AND INSTALLATION  
Listed Room Heater, Pelletized Fuel Type

OR FIRE OFFICIALS ABOUT INSPECTION IN YOUR AREA

Also Suitable for Mobile Home Installation Pursuant to (UM)84-HUD

Tested & Listed by / Testé et Certifié par:

Manufactured by / Manufacturé par:



317 Stafford Ave., Morrisville, VT 05661, USA

SERIAL #   
NO SÉRIE

MODEL NAME: HERITAGE 8091

TESTED TO: ASTM E1509-04,  
ULC/ORD C1482-M1990,  
ULC S627-00

REPORT #: 261-S-04b-2

Type of Fuel: For Use With Pelletized Wood Fuel Only

The use of other fuels may damage the unit.

Electrical Rating: 120 V, 4 A, 60 Hz

Input Rating: 15,300 to 51,000 BTU Typical

Note: Replace glass only with 5mm Ceramic IR or Neoceram IR glass.

Components required for residential and mobile home installation: Listed 3" or 4" Pellet Vent.

DANGER: Risk of electrical shock. Disconnect power before servicing unit. Do not route power cord beneath heater.

WARNING: Do not obstruct the space beneath the heater.

NOTE: Do not open the ash pan or front door until the stove has cooled completely.

"PREVENT HOUSE FIRES"  
Install and use only in accordance with manufacturer's installation instructions and your local building codes.

CAUTION: Special methods are required when passing chimney through a wall or ceiling. Follow the pipe manufacturer's instructions and local building codes for the clearance to combustibles required for the installation of the vent pipe being used. Do not pass chimney connector through a combustible surface. Do not connect this unit to a chimney flue serving another appliance. If not using an outside air inlet for combustion a source of fresh air must be provided to the room.

Room Heater, Pellet Fuel-Burning Type, Also For Use In Mobile Homes.

WARNING: (MOBILE HOME)

An outside air inlet must be provided for combustion and be unrestricted while unit is in use.

### Clearance to Combustible Materials

Refer to the Manual for additional clearance and operation information.

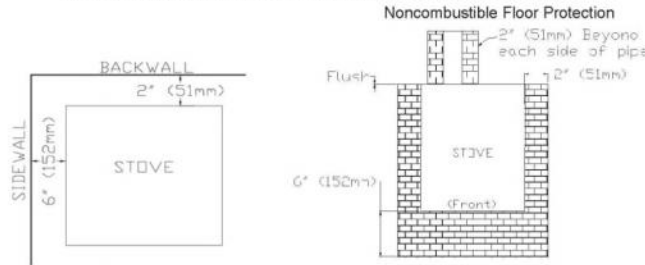

## CAUTION

- Hot while in operation.
  - Do not touch, keep children, clothing, and furniture away.
  - Contact may cause skin burns.
- See name plate and instructions.

DO NOT OVER-FIRE. IF HEATER OR CHIMNEY CONNECTOR GLOWS, YOU ARE OVER-FIRING. INSPECT AND CLEAN CHIMNEY AND CONNECTOR FREQUENTLY. UNDER CERTAIN CONDITIONS OF USE, FLY ASH BUILDUP MAY OCCUR RAPIDLY. MOVING PARTS MAY CAUSE INJURY.

CAUTION: OPERATE THIS UNIT ONLY WITH THE FUEL HOPPER LID CLOSED. FAILURE TO DO SO MAY RESULT IN EMISSIONS OF PRODUCTS OF COMBUSTION FROM THE HOPPER UNDER CERTAIN CONDITIONS. MAINTAIN HOPPER SEAL IN GOOD CONDITION. DO NOT OVERFILL THE HOPPER.

WARNING: RISK OF SMOKE AND FLAME SPILLAGE, KEEP VIEWING AND ASH REMOVAL DOORS TIGHTLY CLOSED DURING OPERATION.

U.S. ENVIRONMENTAL PROTECTION AGENCY  
Certified to comply with July 1990 particulate emission standards.

DATE OF MANUFACTURE / DATE DE FABRICATION

2012 2013 2014 JAN FEB MAR APR MAY JUN JUL AUG SEP OCT NOV DEC

DO NOT REMOVE OR COVER THIS LABEL

3300-637

## Customized Set Up Data:

Mountain View Hearth Products  
manuals.stove-parts-unlimited.com