



Manchester

(Model 8330)

Pellet Stove

OWNER'S MANUAL Operating Instructions



Please read this entire manual before installation and use of this pellet fuel burning room heater. Failure to follow these instructions could result in property damage, bodily injury, or even death.

CONTACT LOCAL BUILDING OR FIRE OFFICIALS ABOUT RESTRICTIONS AND INSTALLATION INSPECTION REQUIREMENTS IN YOUR AREA.

SAVE THESE INSTRUCTIONS FOR FUTURE REFERENCE!



We recommend that our products be installed and serviced by professionals who are certified in the U.S. by NFI (National Fireplace Institute).

www.nficertified.org

Tested & Listed By



Portland
Oregon USA

OMNI-Test Laboratories, Inc.

Manchester Pellet Model 8330
Report: 261-S-04b-2
Manual: 6400-40468
R: 4 - 7/31/2012

Intentionally Blank

Mountain View Hearth Products
manuals.stove-parts-unlimited.com

Table of Contents

Introduction	4
Important Notes	4
Specifications	6
General Specifications	7
Electrical Specifications	7
Components	8
Operation	10
Loading Pellets	10
Modes of Operation	11
Quick Operations Guide	12
Ash Disposal	30
Maintenance	31
Daily	31
Weekly or as Needed	32
Monthly	32
Yearly or Every Ton of Pellets	33
As Needed	35
Glass Replacement Procedures	36
Troubleshooting	37
Display Messages:.....	37
General Issues:.....	39
Replacement Parts & Optional Accessories List	41
Safety Label	42

Introduction

Congratulations on your purchase of Hearthstone's Manchester pellet fired stove. The Manchester Pellet stove incorporates the latest in pellet burning technology providing you with clean, efficient heat for years to come. Your decision to purchase a Hearthstone Manchester Pellet stove reflects a choice to purchase a premium product and a technology which is carbon neutral, meaning that operation of this stove will not introduce any "new" CO₂ into our atmosphere and minimizes your carbon footprint.

Burning pellets produces essentially the same amount of CO₂ that the same amount of wood decomposing in the forest would produce. Purchase of this product illustrates forward thinking and the thoughtfulness to purchase an environmentally responsible product.

Pellet fuel is proven to provide the cleanest burn of any solid fuel, exhausting an average well below the United States EPA wood burning limit. Your Hearthstone Manchester Pellet stove is certified at 1.3g/hr of particulate emissions, well below the EPA standard of 7.5 g/hr, making your stove not only beautiful, but extremely clean burning and efficient as well. This is because the combustion air is closely monitored and modulated by our on-board computer, which optimizes the burn efficiency.





If you have any questions, comments or concerns please contact your local Hearthstone authorized dealer. They are certified industry professionals and should always be consulted on the installation and operation of your Hearthstone appliance for premium performance and trouble free operation and installation.

Hearthstone Quality Home Heating Products offers the best warranty in the industry. Satisfied customers are our top priority.

Important Notes

Please Read this Owner's Manual

Please read this manual in its entirety before installing your stove, thoroughly reading and understanding this manual will help you operate and maintain this pellet heater to ensure years of efficient, economical use. Please operate your stove in accordance with the instructions in this manual. For your safety and trouble free operation, observe a few simple safety precautions and perform some minimal maintenance. The unit will remain appealing while providing years of quality performance.

-  **WARNING: ENSURE ONLY A HEARTHSTONE DEALER OR AN NFI CERTIFIED PELLET SERVICE TECHNICIAN INSTALLS, AND REPAIRS THIS APPLIANCE. A QUALIFIED SERVICE TECHNICIAN MUST INSPECT THE APPLIANCE BEFORE USE, AND AT LEAST ANNUALLY.**
-  **WARNING: REGULAR CLEANING IS REQUIRED OR ASH BUILDUP IN THE FIRE BOX COULD IMPEDE OPERATION. IT IS IMPERATIVE THAT THE CONTROL COMPARTMENTS AND CIRCULATING AIR PASSAGES OF THE APPLIANCE ARE KEPT CLEAN AND FREE OF OBSTRUCTIONS. THIS IS NOT A SET AND FORGET APPLIANCE!**
-  **NEVER BURN PAPER, WOOD OR OTHER MATERIALS**
-  **CAUTION: DO NOT OPEN THE FRONT DOOR OR ASH PAN UNTIL THE STOVE HAS COOLED COMPLETELY.**

The Manchester Pellet is a pellet fuel burning heater certified and is designed to burn premium natural wood pellets only. Never burn any fuel not intended for use with this unit.

Hot Surfaces

Certain exposed surfaces of the Manchester will reach high temperatures during normal operation. Clearances to combustibles must be maintained, as specified in the "Clearances to Combustibles" section of this manual.

-  **DUE TO HIGH TEMPERATURES, LOCATE THE APPLIANCE OUT OF TRAFFIC LANES AND AWAY FROM FURNITURE, DRAPERIES, CLOTHING AND FLAMMABLE MATERIALS. AS A GENERAL RULE, KEEP ALL COMBUSTIBLES 36 INCHES AWAY.**

Alert children and adults to the hazards of high surface temperatures and the need to stay away to avoid burns to skin or clothing ignition.

Introduction

Ensure young children are carefully supervised when in the same room as the appliance. Do not place clothing or other flammable material on or near the appliance.

Fire Hazard

- 🔥 **In the unlikely event of a soot, or creosote fire – leave the front door and ash drawer closed and shut the unit off (unplug the unit if the chimney fire does not go out immediately). Have the unit and venting inspected before further use.**
- 🔥 **Do not store or use gasoline or other flammable vapors or liquids in the vicinity of this appliance. Locate stove out of traffic and away from furniture, draperies, clothing, and flammable material.**
- 🔥 **Never use gasoline, gasoline-type lantern fuel, kerosene, charcoal lighter fluid, or similar liquids to start or ‘freshen up’ a fire in this heater. Keep all such liquids well away from the heater while it is in use.**

Mountain View Hearth Products
manuals.stove-parts-unlimited.com

Specifications

Listed as: Pellet-Fired Direct-Vent Fireplace Heater

Model: Manchester Pellet (8330)

Testing Agency: OMNI-Test Laboratories, Inc.

Tested to:

- ASTM E 1509-04 Standard Specification for Room Heaters, Pellet Fuel-Burning Type
- ULC/ORD-C1482-M1990 Requirements for Space Heaters for Use with Particulate Solid Fuels
- ULC-S627-00 Space Heaters for Use with Solid Fuels

Report No.: 261-S-04b-2 Certified for US and Canada.

Approved for Mobile Home Installation

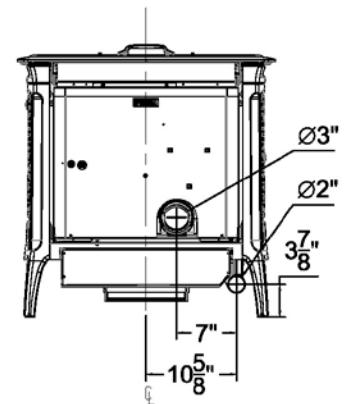
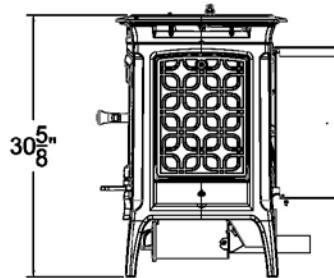
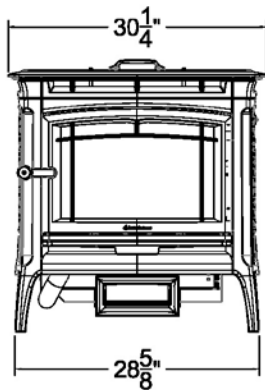
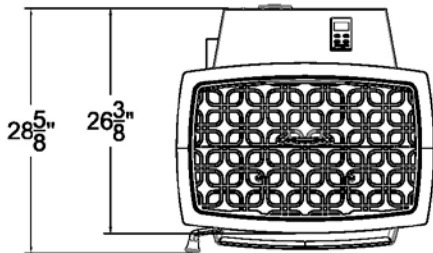

Output Specifications

% max burn	lbs/hr	BTU's*	Hours of burn, 40lb
30	1.8	15,300	22.2
45	2.7	22,950	14.8
70	4.2	35,700	9.5
100	6.0	51,000	6.7

*BTU measurements assume 8,500 btu/lb. Lower quality fuel will reduce heat output and overall performance.

Specifications

General Specifications

Stove Weight.....	350 lbs
Pellet Hopper Capacity.....	50 lbs*
Approximate Heating Ability (sq ft).....	up to 2000 sq ft
Burn Rate (lbs/hr).....	1.8 – 6.00 lbs/hr
Fuel.....	PFI certified premium or better Wood Pellets
<i>(Refer to Appendix A for more information about pellet fuel in general)</i>	
EPA Certified Particulate Emissions.....	1.3g/hr
<i>(EPA Standard – 7.5 g/hr)(Data from Omni-Test Laboratories, Inc. Report: 261-S-04-8.3)</i>	

Electrical Specifications

Electrical Rating.....120 V.A.C. 60Hz, 4 Amps

(A grounded surge protector is recommended to protect the circuit board. If the voltage entering your home is below 116 volts your stove may not work properly. Ensure that the polarity of the electrical receptacle that the stove is plugged into is correct.)

Fuse replacement: 3.5 amp minimum to 4 amp maximum rating. Hearthstone PN 7000-185

Watts used (startup) (approx).....	300 Watts
Watts used (max/high burn) (approx).....	160 Watts
Watts used (min/low burn) (approx).....	60 Watts

*All void spaces in hopper filled.

^Dependent on energy efficiency of structure, fuel quality, user operation, and your installation.

Components

Components and features:

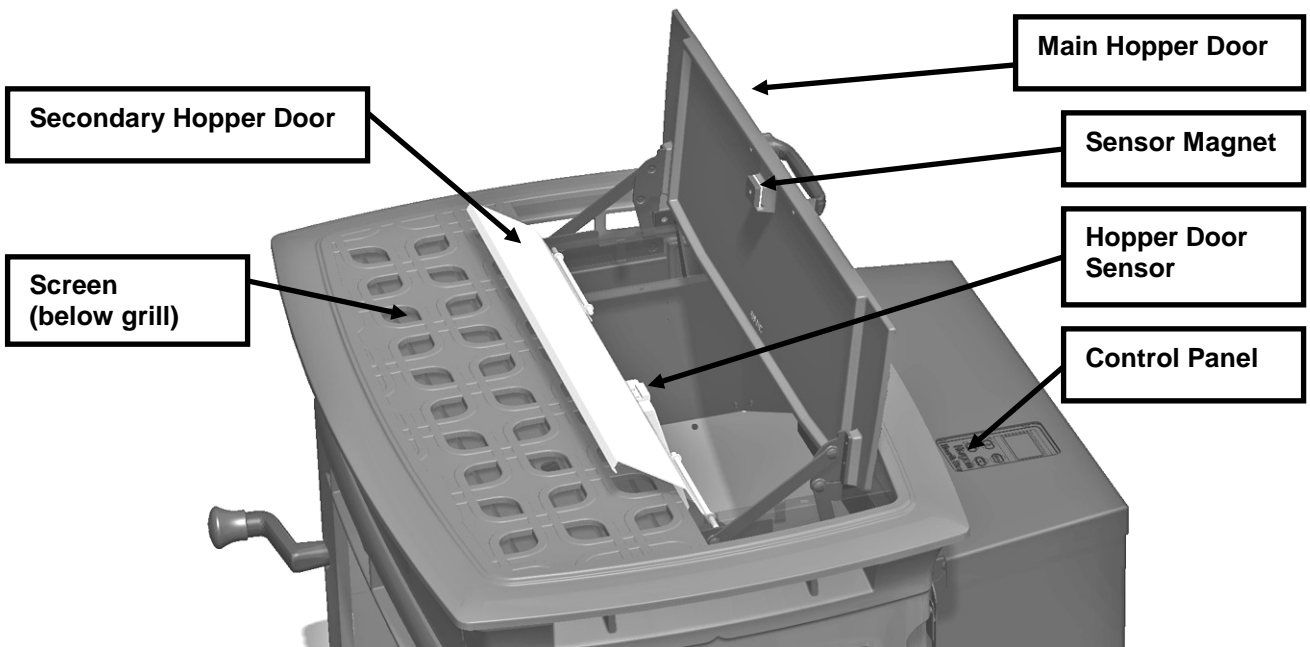
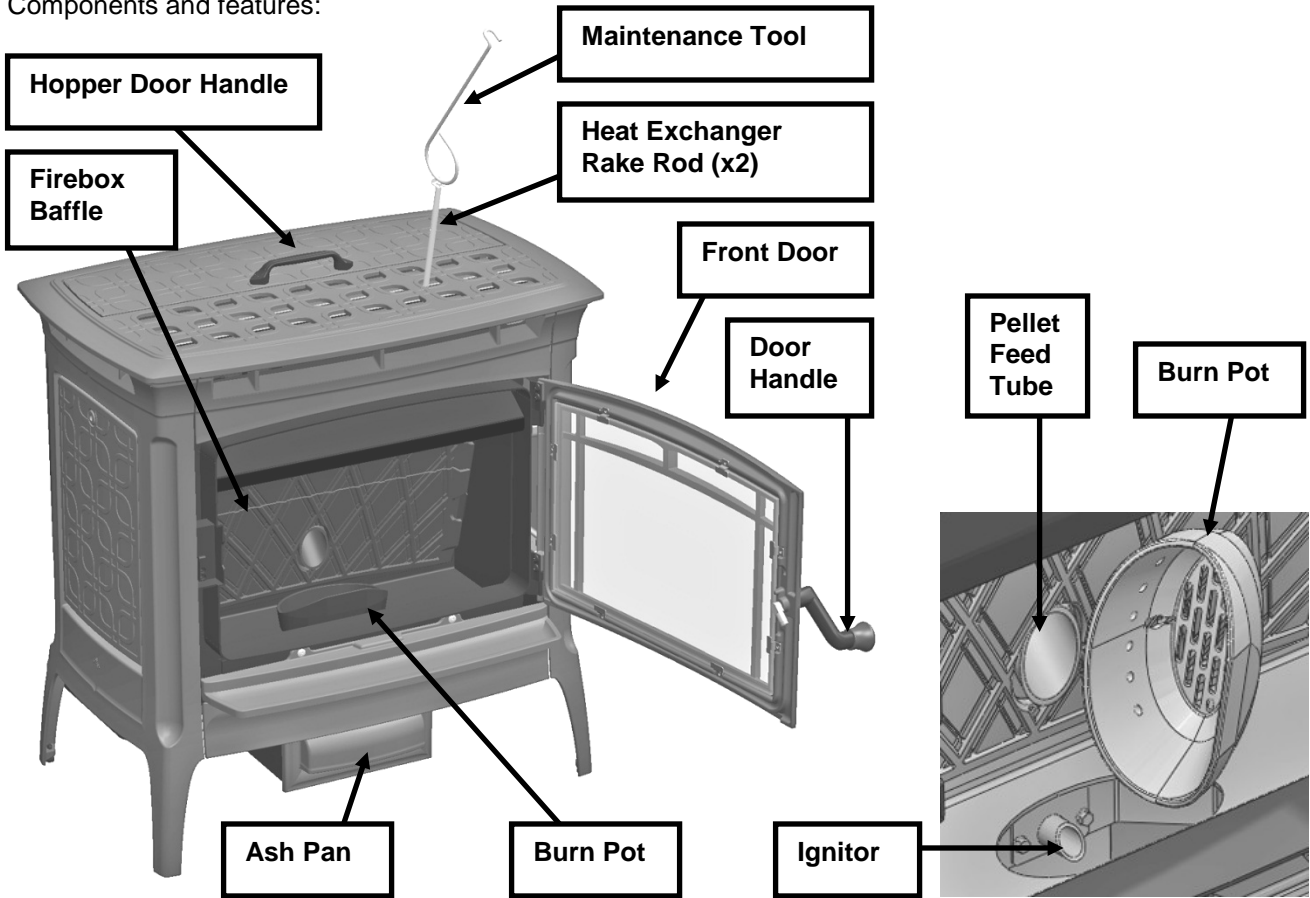

Components

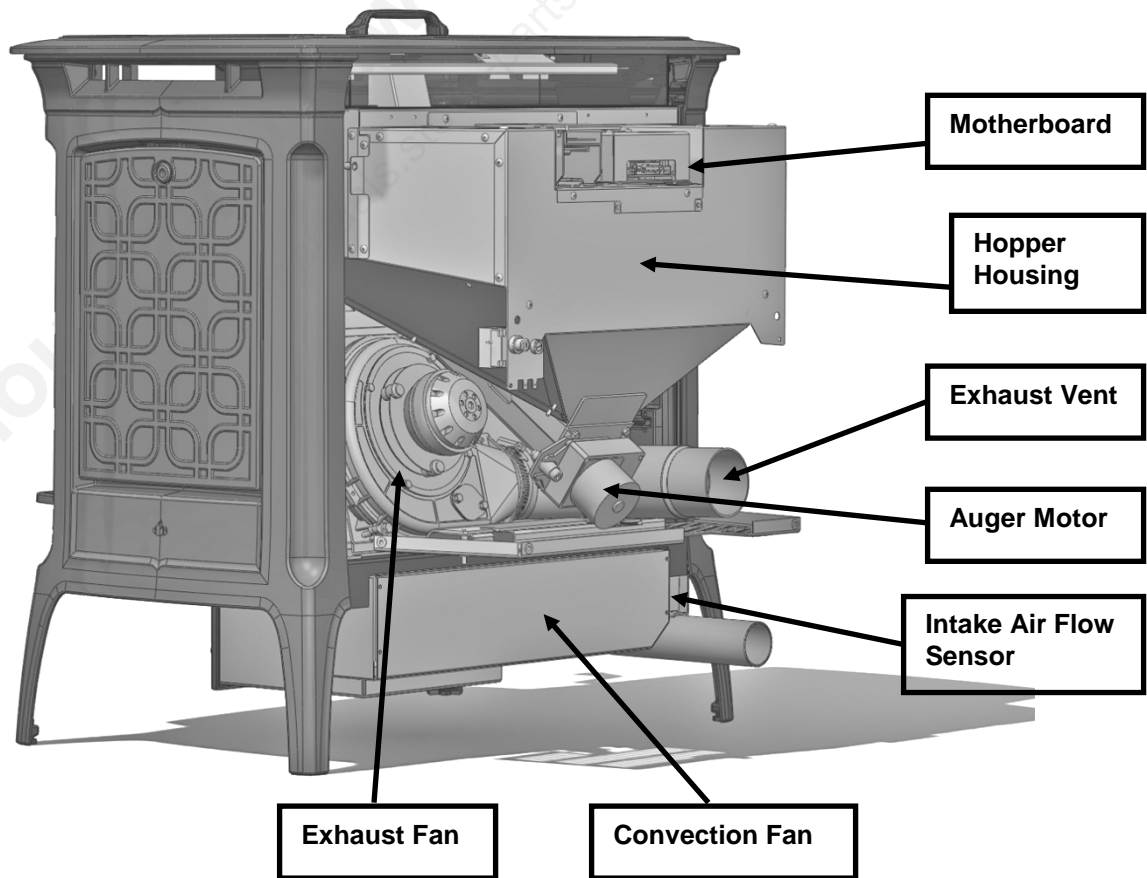
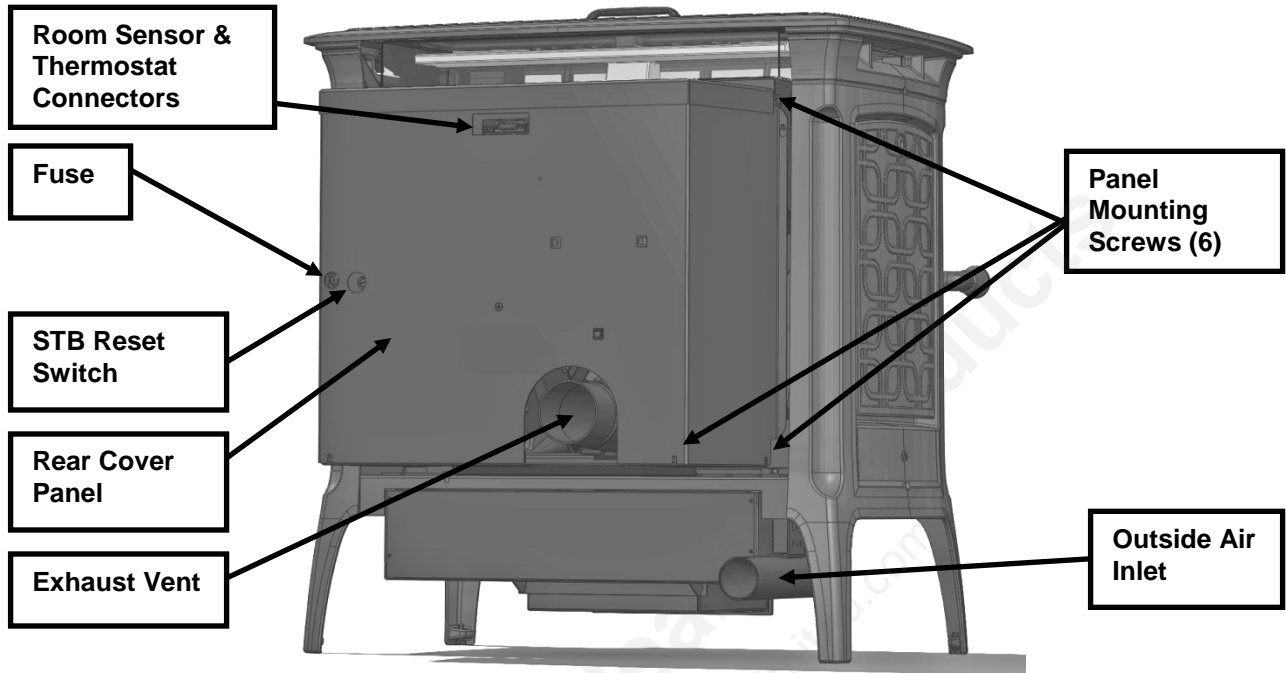

Operation

- 🔥 **CAUTION: HOT WHILE IN OPERATION! KEEP CHILDREN, CLOTHING, AND FURNITURE AWAY. CONTACT MAY CAUSE SKIN BURNS.**
- 🔥 **CAUTION: DO NOT USE CHEMICALS OR FLUIDS TO START THE FIRE.**
- 🔥 **CAUTION: DO NOT BURN GARBAGE, FLAMMABLE LIQUIDS SUCH AS GASOLINE, NAPHTHA, OR ENGINE OIL.**
- 🔥 **CAUTION: THIS UNIT IS DESIGNED TO BURN ONLY PREMIUM NATURAL WOOD PELLETS. DO NOT BURN ANY OTHER MATERIAL NOT DESIGNATED AS WOOD PELLET FUEL. USE OF CHUNK WOOD IN THIS STOVE IS PROHIBITED BY LAW. BURNING ANYTHING OTHER THAN WOOD PELLET FUEL CAN CAUSE OVERFIRING, DAMAGE THE APPLIANCE, AND WILL VOID THE WARRANTY.**
- 🔥 **USE ONLY THE BURN POT DESIGNED FOR THIS STOVE – DO NOT SUBSTITUTE WITH OTHER PARTS OR USE A GRATE TO HOLD THE FUEL.**
- 🔥 **WARNING: DO NOT ABUSE THE FRONT DOOR GLASS BY STRIKING, OR BY SLAMMING THE DOOR.**
- 🔥 **CAUTION: DO NOT OPERATE THIS UNIT WITH BROKEN DOOR GLASS.**
- 🔥 **DO NOT ALLOW FIRE TO BURN TOO CLOSE TO THE GLASS.**
- 🔥 **DO NOT OPERATE WITH THE FRONT DOOR, OR ASH DRAWER OPEN – THE UNIT WILL SHUT DOWN.**
- 🔥 **DISCONTINUE OPERATION IF YOU SMELL SMOKE COMING FROM THE HEATER.**
- 🔥 **IF A MALFUNCTION IS SUSPECTED, TURN THE UNIT OFF USING THE CONTROL PANEL, DO NOT UNPLUG!**
- 🔥 **IF THE FLAMES BECOME SOOTY, OR THE BURN POT OVERFILLS WITH PELLETS, IT IS RECOMMENDED TO TURN OFF THE STOVE AND THOROUGHLY CLEAN ALL STOVE AREAS AS PER MAINTENANCE DIRECTIONS.**
- 🔥 **WHEN OPERATING NORMALLY, THIS APPLIANCE COULD TRIGGER SMOKE DETECTORS INSTALLED TOO CLOSE TO THE UNIT.**

Loading Pellets

Lift the hopper door vertically until fully opened, open secondary hopper door; add pellets into hopper until full. In order to maximize hopper capacity, push pellets into void spaces. With all voids full, maximum hopper capacity is approximately 50 lbs of pellets. To reduce the introduction of fines, or spillage, we recommend the use of a secondary container to add pellets. Clean up any pellets spilled on, or down inside the stove.

Store pellets in a dry location, and outside the required clearances to combustibles of the heater.

NOTES:

- 🔥 **WARNING! TOP GRILL AND FRONT EDGE OF STOVE CAN BECOME VERY HOT, AVOID ALL CONTACT WITH HEATED SURFACES**
- 🔥 **IF THE HOPPER DOOR IS LEFT OPEN, A **CAP OPEN** MESSAGE WILL SHOW ON THE DISPLAY. AN OPEN HOPPER DOOR WILL AUTOMATICALLY STOP FUNCTION OF THE FEED AUGER AND IGNITOR, AS THE AUGER POSES A HAZARD TO FINGERS DURING OPERATION. TO ACKNOWLEDGE THIS MESSAGE, SIMPLY CLOSE THE HOPPER DOOR.**

All operations of the stove are initiated from the User Interface pad. This pad is designed to provide simple, user-friendly operation of the stove. There are only four buttons on the interface pad, **Power (On/Off)**, **MENU**, **+**, **-**. During normal operation, the interface screen will illuminate red. When the unit is in OFF mode, but power is supplied, the pad will display its operational state without the red backlighting. If an error is detected, an error message is displayed, and the readout will flash.

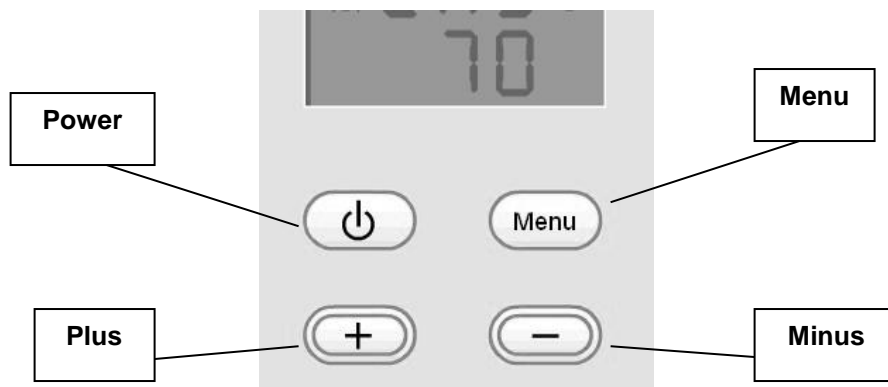

Operation

Modes of Operation

The Manchester Pellet Stove has various modes of operation. They are:

- 🔥 **Manual** – Most basic mode (no thermostatic control).
- 🔥 **Thermostat** – Optional mode. Requires an external milli-volt thermostat sold at your local Hearthstone dealer or hardware store.
- 🔥 **Automatic** – Easiest automatic mode. Requires the use of the Hearthstone's Room Sensor (*included with the stove*).
- 🔥 **Programmable** – Best automatic mode. Requires the use of the Hearthstone's Room Sensor (*included with the stove*).

Note: If the stove is triggered to shut down and then triggered to turn back on immediately, it may still go through the complete shut down and startup process.

hearthstone Pellet Stoves

Basic Setting : MAN Mode

Operation:

- Operating in the Basic Setting : MAN Mode (Manual mode)
- Turning the stove ON / OFF and adjusting the Heat Output

Conditions • Stove Plugged In

- No Thermostat Connected
- No Room Sensor Connected

1 Plug in the stove:

This indicates that the stove is in MAN Mode. This is the factory setting.

2 Turning on the stove:

This indicates that the stove is igniting. Allow up to 10 min. for the stove to ignite.

PRESS POWER BUTTON

Press and release buttons quickly, unless otherwise noted.

This indicates that the stove is ignited, and climbing toward the Heat Output setting.

3 Adjust the Heat Output:

This shows the percentage of heat output. PRESS + or - to go between 30(%) and 100(%)

PRESS + or - BUTTON

PRESS MULTIPLE TIMES

4 Turning off the stove:

This indicates that the stove is stopping. Allow 10 minutes for the stove to turn off.

PRESS POWER BUTTON

HOLD **3** SECONDS

This indicates that the stove is OFF. The stove may now be restarted.

Advanced Setting : TSTAT Mode

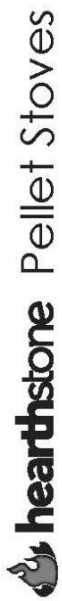

Operation:

- Stove Plugged In
- Thermostat Connected (UL apprv Millivolt)
- No Room Sensor Connected

- Switching between MAN Mode / TSTAT Mode (Thermostat Mode)
- Operating in TSTAT Mode

1 Switching between MAN Mode / TSTAT Modeo, Starting the stove in TSTAT Mode:

When the Menu button is released, the screen will change to TSTAT Mode.

PRESS MENU BUTTON HOLD 15 SECONDS

To return to MAN mode, repeat step 1.

This indicates that the stove is in TSTAT Mode. Press the Power Button to start the stove.

PRESS POWER BUTTON

Press and release buttons quickly, unless otherwise noted.

This shows the percentage of heat output. PRESS + or - to go between 30(%) and 100(%). The thermostat (connected to the back of the stove) will stop and start the stove, always running at the indicated Heat Output.

Allow up to 10 min. for the stove to react to temperature setting changes.

3 Running Cycle in TSTAT Mode:

The stove is igniting, and climbing toward the Heat Output setting.

The stove is igniting, and climbing forward the Heat Output setting.

The stove is stopping.

The stove is in standing by. Room temp. is satisfied.

4 Turning off the stove:

PRESS POWER BUTTON HOLD 3 SECONDS

This indicates that the stove is OFF.

Operation:

- Switching between MAN Mode / AUTO Mode (Automatic Mode)
- Operating in AUTO Mode

Conditions

- Stove Plugged In
- No Thermostat Connected
- Room Sensor Connected

1 Enter the Advanced Setting:

To return to MAN mode, repeat step 1.

The TSTAT OFF screen indicates that you are in the Advanced setting.

2 Enter the MODE menu:

Press the Menu Button to scroll to the MODE screen.
Press the Power Button while on the MODE screen to enter the Mode menu.

Operation:

- Switching between MAN Mode / AUTO Mode (Automatic Mode)
- Operating in AUTO Mode

Conditions

- Stove Plugged In
- No Thermostat Connected
- Room Sensor Connected

3 Selecting AUTO Mode:

This screen indicates that you are in the MODE menu. Note that the line is blank below the words ISTAT, AUTO, or PROG

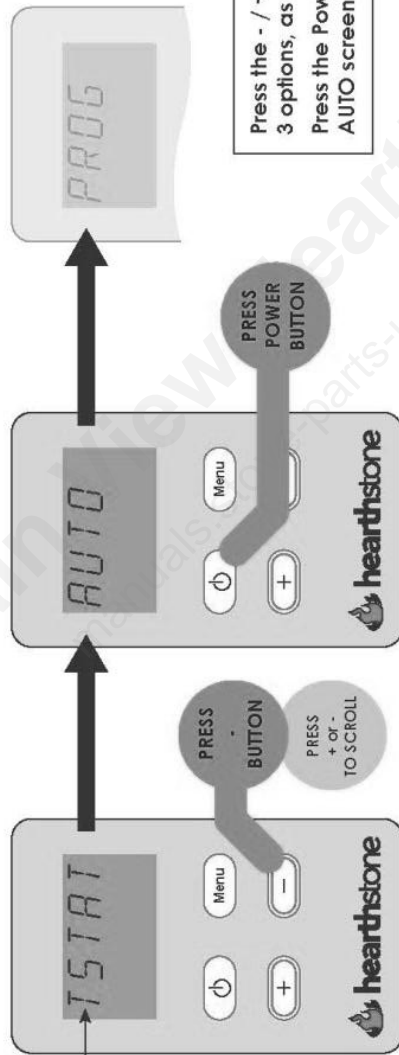

Press the - / + Buttons to scroll through 3 options, as shown. Press the Power Button while on the AUTO screen to select AUTO Mode.

4 Starting your stove in AUTO Mode:

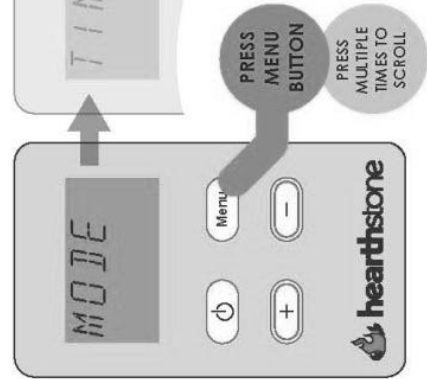

Press the Menu Button to scroll through 5 options, as shown. Press the Power Button while on the AUTO OFF screen to activate Automatic Mode.

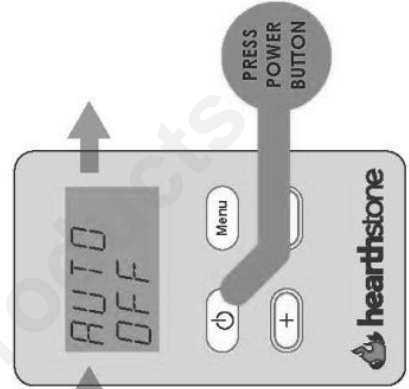

Advanced Setting :AUTO Mode



Operation:

- Switching between MAN Mode / AUTO Mode (Automatic Mode)
- Operating in AUTO Mode

Conditions

- Stove Plugged In
- No Thermostat Connected
- Room Sensor Connected

5 Adjusting the Heat Output:

The Home temp. setting can be adjusted at any stage of the running cycle (running cycle shown in Step 22)

This indicates that the stove is in Automatic Mode.

This shows the target room temperature in degrees Fahrenheit.

PRESS + or - to increase or decrease the temperature setting by 1°F. The Room Sensor will sense the temperature of the room, and run the stove in order to maintain the set temperature.

Allow up to 10 min. for the stove to react to temperature setting changes.

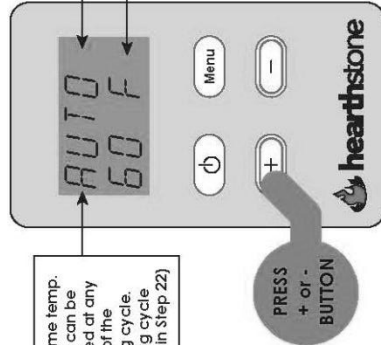

6 Turning off the stove:

PRESS POWER BUTTON HOLD 3 SECONDS

This indicates that the stove is OFF.

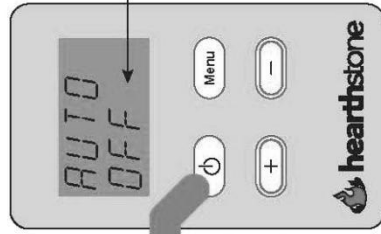

7 Running Cycle in Automatic Mode:

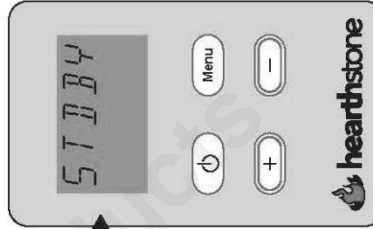
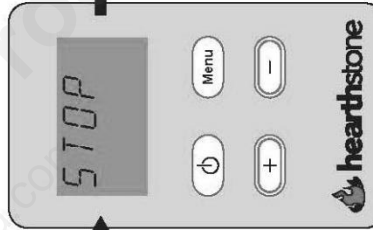
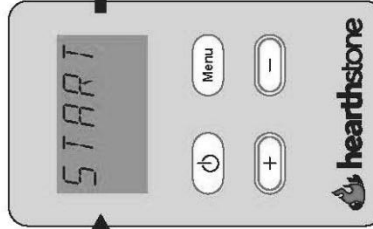
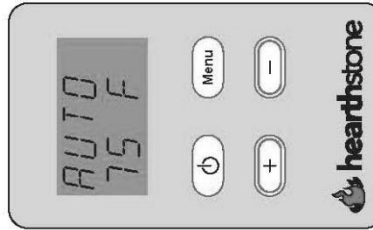

Operation:

- Switching between MAN Mode / PROG Mode (Programmable Mode)
- Operating in PROG Mode

Conditions

- Stove Plugged In
- No Thermostat Connected
- Room Sensor Connected

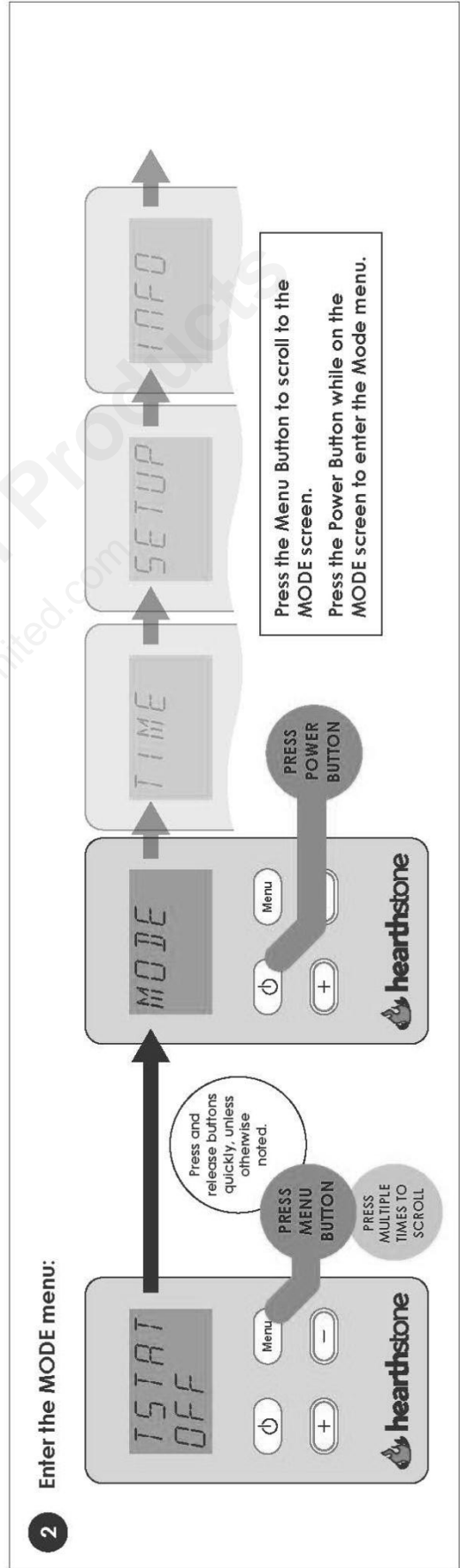
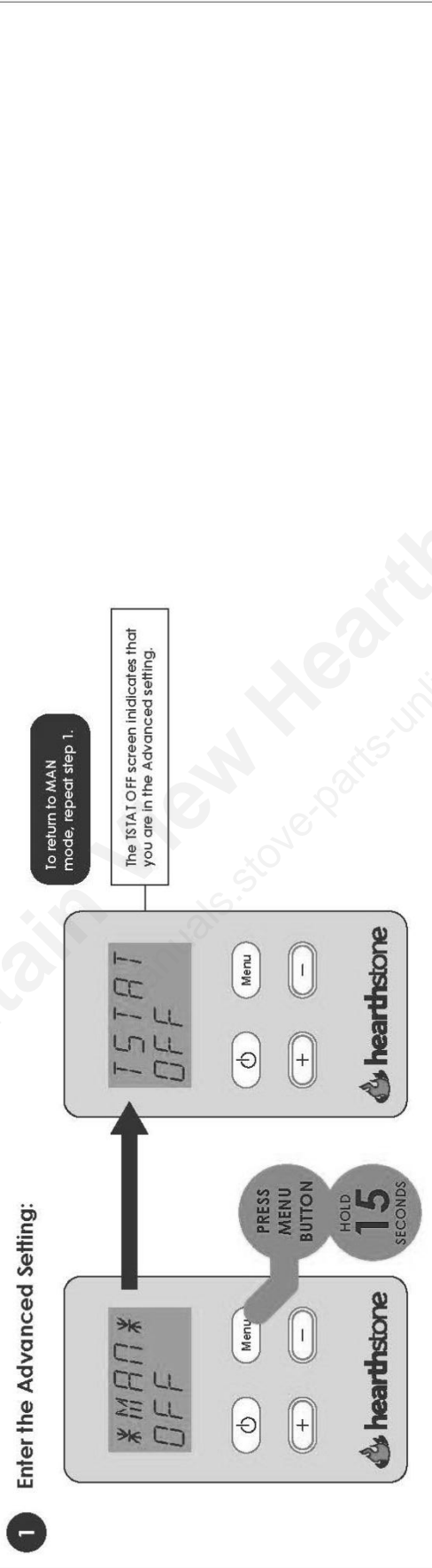

Operation:

- Switching between MAN Mode / PROG Mode (Programmable Mode)
- Operating in PROG Mode

Conditions

- Stove Plugged In
- No Thermostat Connected
- Room Sensor Connected

3 Selecting PROG Mode:

This screen indicates that you are in the MODE menu.
Note that the line is blank below the words TSTAT, AUTO, or PROG

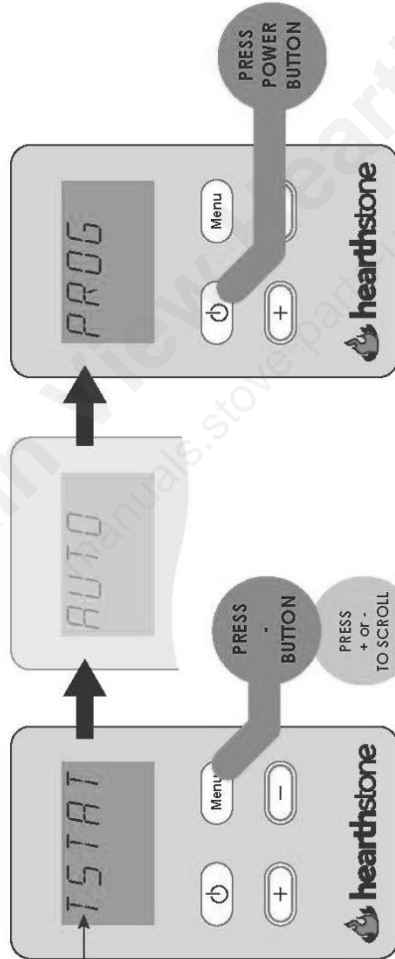

Press the - / + Buttons to scroll through 3 options, as shown.
Press the Power Button while on the PROG screen to select PROG Mode.

4 Enter the Time menu:

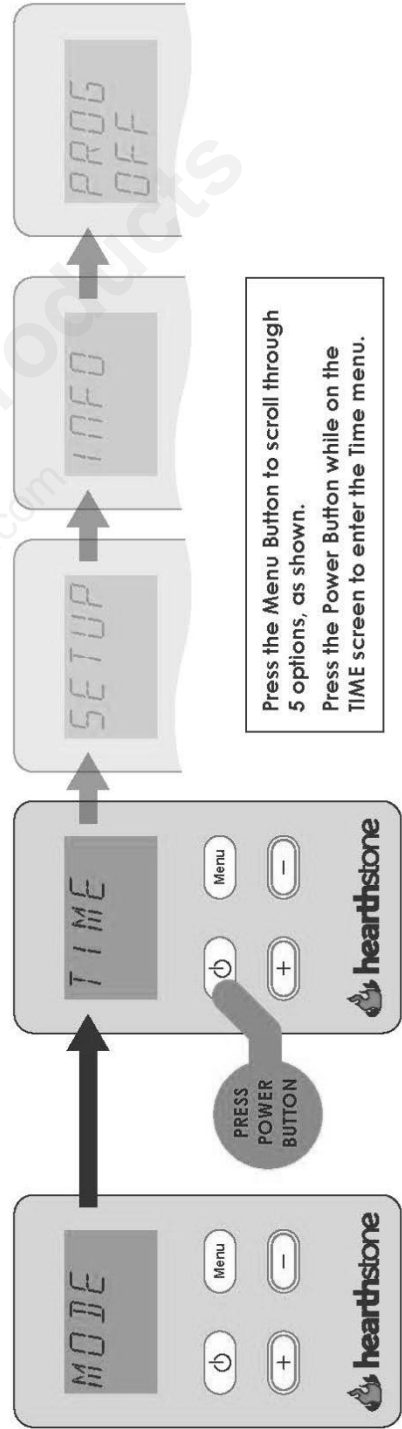

Press the Menu Button to scroll through 5 options, as shown.
Press the Power Button while on the TIME screen to enter the Time menu.

Operation:

- Switching between MAN Mode / PROG Mode (Programmable Mode)
- Operating in PROG Mode

Conditions

- Stove Plugged In
- No Thermostat Connected
- Room Sensor Connected

5 Enter the TIME SET Menu:

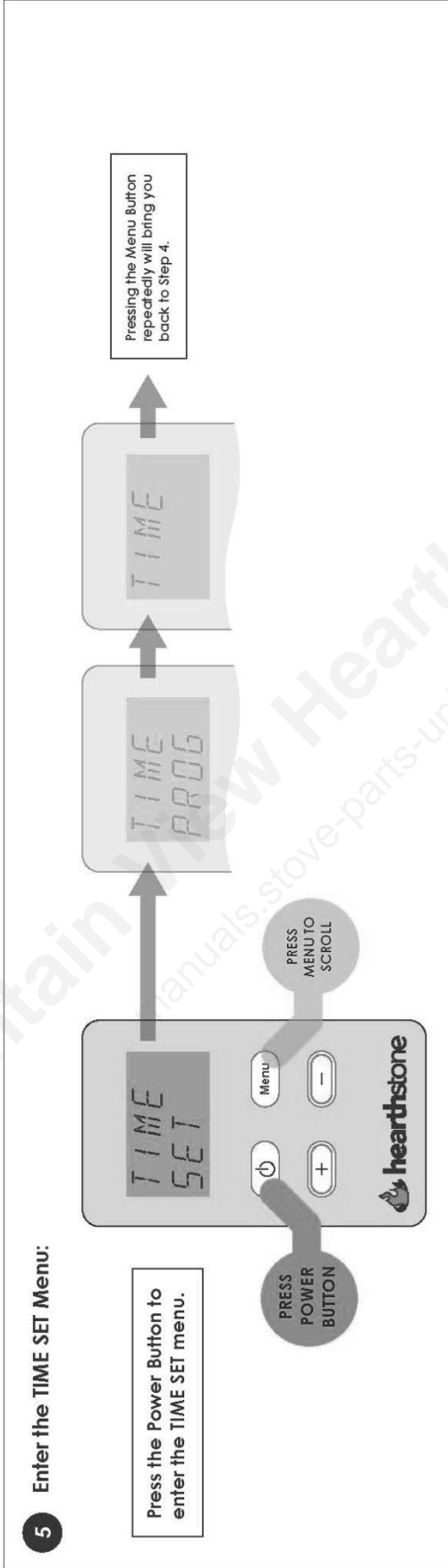

Press the Power Button to enter the TIME SET menu.

Press the Menu Button repeatedly will bring you back to Step 4.

6 Setting the time:

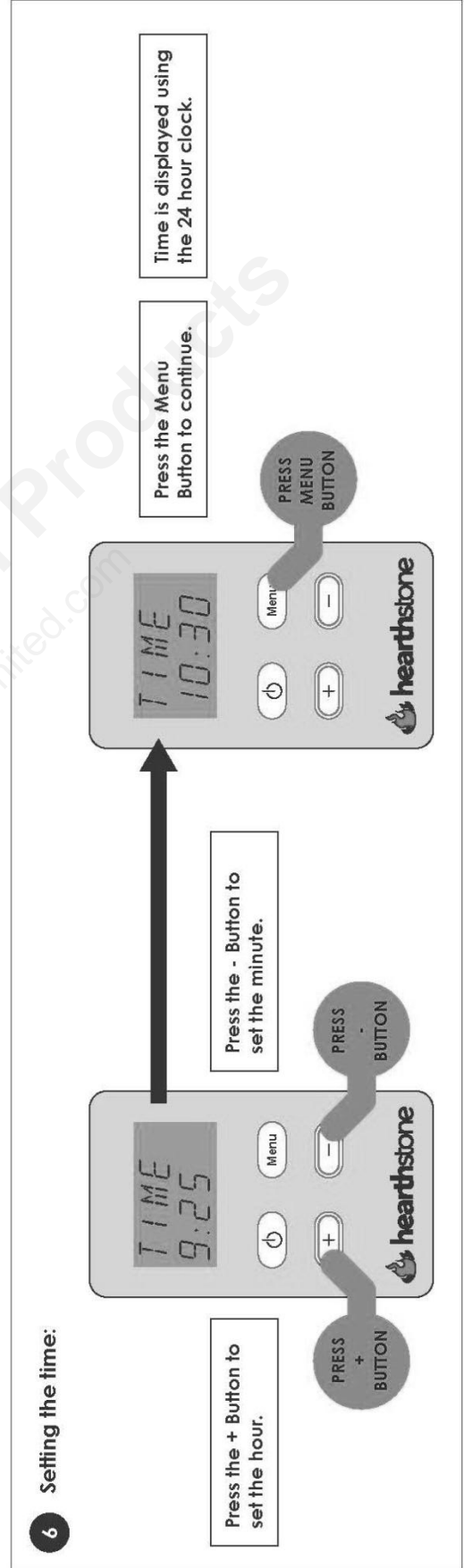

Press the + Button to set the hour.

Press the - Button to set the minute.

Press the Menu Button to continue.

Time is displayed using the 24 hour clock.

hearthstone Pellet Stoves

Advanced Setting :PROG Mode

Operation:

- Switching between MAN Mode / PROG Mode (Programmable Mode)
- Operating in PROG Mode

Conditions

- Stove Plugged In
- No Thermostat Connected
- Room Sensor Connected

7 **Setting the day:**

Press the + or - Button to select the current day of the month.

Press the Menu Button to continue.

PRESS + or - BUTTON

PRESS MENU BUTTON

8 **Setting the month:**

Press the + or - Button to select the current month.

Press the Menu Button to continue.

PRESS + or - BUTTON

PRESS MENU BUTTON

9 **Setting the year:**

Press the + or - Button to select the current year.

Pressing the Menu Button to continue.

PRESS + or - BUTTON

PRESS MENU BUTTON

10 **Confirm the Time / Date settings:**

Pressing the Menu Button to confirm that the day is correct.

PRESS MENU BUTTON

This indicates the current day of the week.

MO (Monday)
TU (Tuesday)
WE (Wednesday)
TH (Thursday)
FR (Friday)
SA (Saturday)
SU (Sunday)

hearthstone Pellet Stoves

Advanced Setting :PROG Mode

Operation:

- Switching between MAN Mode / PROG Mode (Programmable Mode)
- Operating in PROG Mode

Conditions

- Stove Plugged In
- No Thermostat Connected
- Room Sensor Connected

11 Programming Options:

Programming your stove allows you to set 2 different Heat Output levels: one for when you are Home, and one for when you are Away.

Your stove must be set with 2 Home time periods. This would typically mean one Home time period in the morning, and one Home time period in the evening. The Away time periods fall in between the Home time periods.

You must choose one of two options when programming your stove: WEEK or DAY

WEEK - Set one program for the week, every day will run on the same schedule.

DAY - Set a specific program for each day of the week.

12 Enter the TIME PROG Menu:

Press the Power Button to enter the TIME PROG menu.

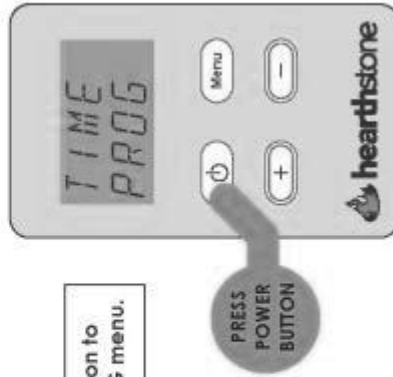

13 Setting one program for the week:

Press the Power Button while on the WEEK screen to set one program for all days of the week.

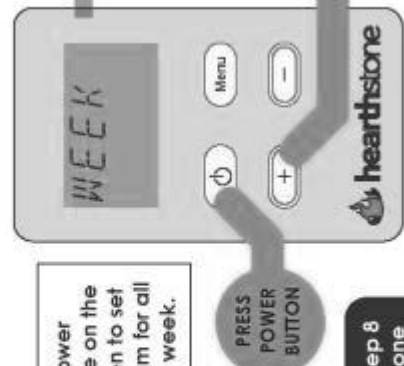

Skip to step 8 if setting one program for the week

14 Setting a program for each day of the week:

Press the + Button to scroll to the DAY screen. Press the Power Button to Program the individual days.



This indicates the day of the week to be programmed.

Operation:

- Switching between MAN Mode / PROG Mode (Programmable Mode)
- Operating in PROG Mode

Conditions

- Stove Plugged In
- No Thermostat Connected
- Room Sensor Connected

15 Setting the first Home time period:

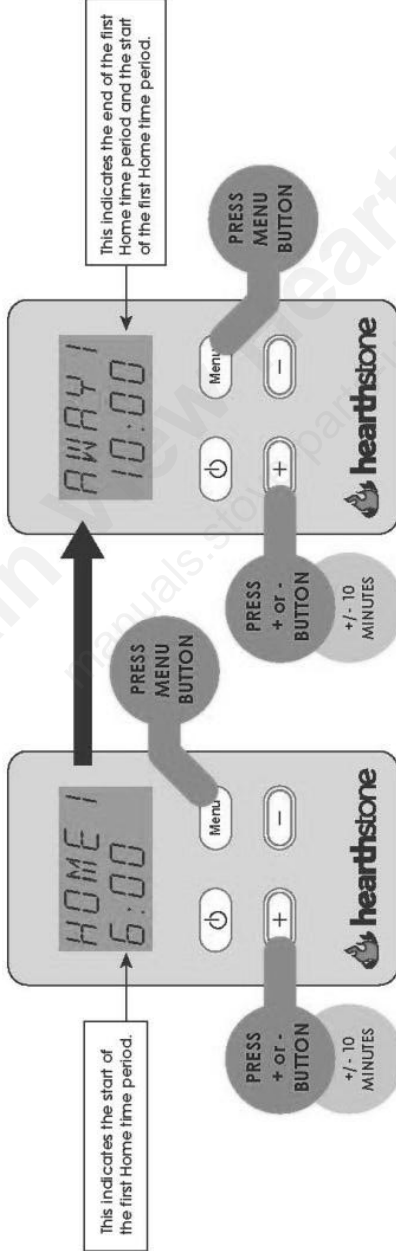

Time is displayed using the 24 hour clock.

This sets the beginning time and end time between which you are usually at home in the morning. In this case, between 6:00am and 10:00am the stove will run at the Home temperature. Before and after this time period, the stove will run at the Away temperature. Both the Home and Away temperatures will be defined after programming.

16 Setting the second Home time period:

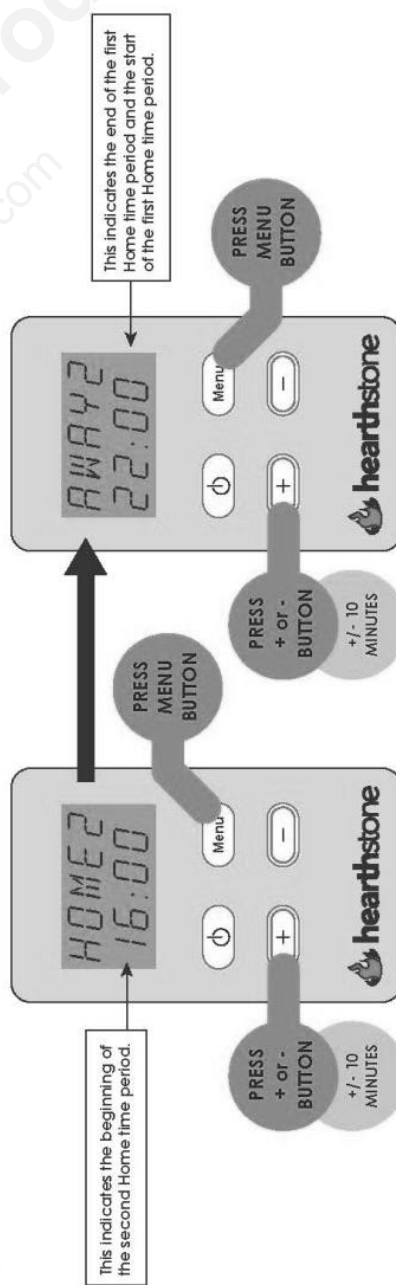

Time is displayed using the 24 hour clock.

This sets the beginning time and end time between which you are usually at home in the evening. In this case, between 4:00pm and 10:00pm the stove will run at the Home temperature. Before and after this time period, the stove will run at the Away temperature. Both the Home and Away temperatures will be defined after programming.

Operation:

- Switching between MAN Mode / PROG Mode (Programmable Mode)
- Operating in PROG Mode

Conditions

- Stove Plugged In
- No Thermostat Connected
- Room Sensor Connected

17 Starting the stove with one program for the week: (Only applies if you followed step 13)

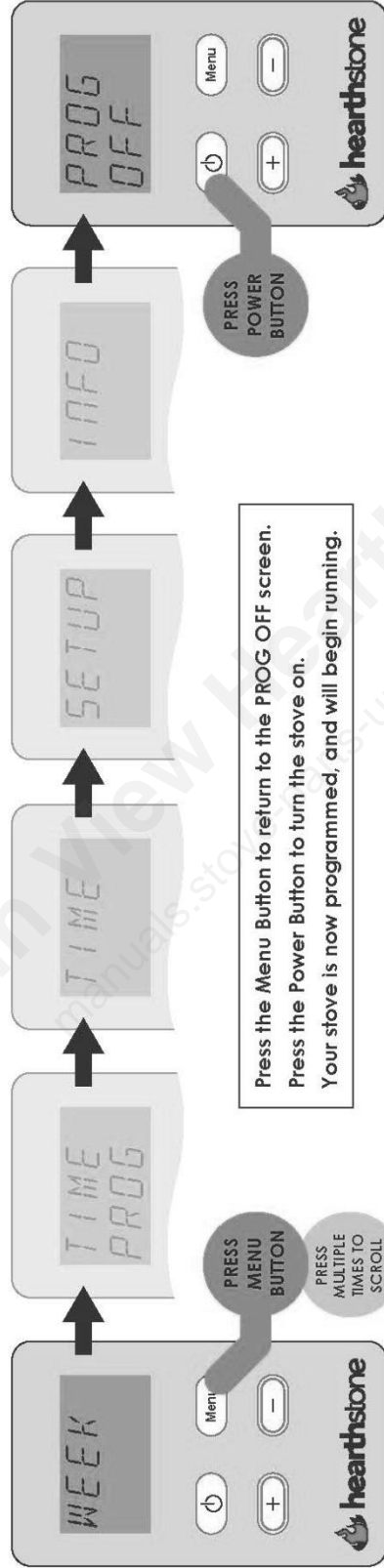

18 Programming each day of the week: (Only applies if you followed step 14)

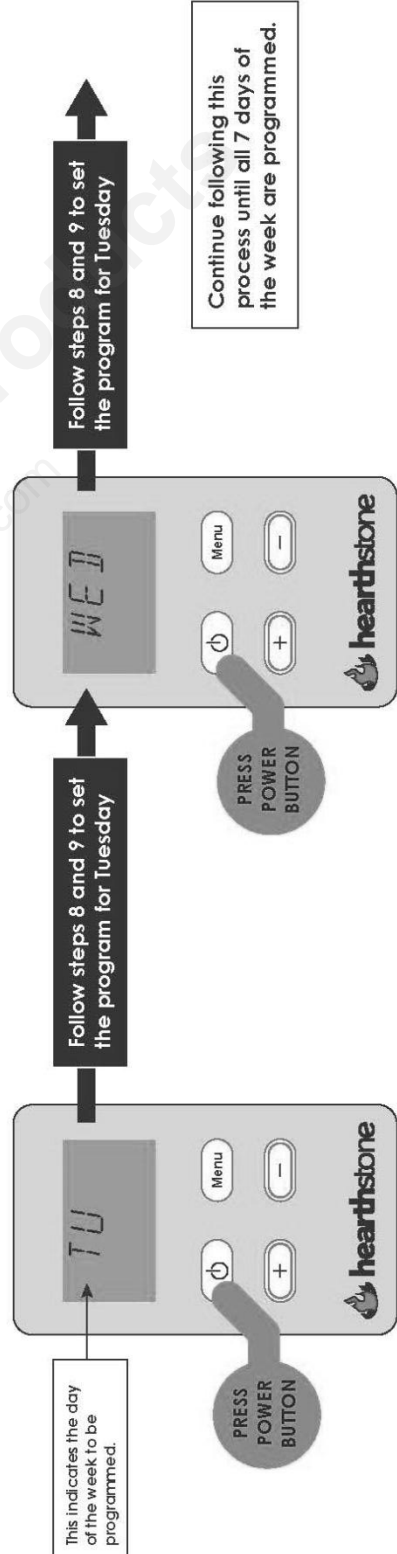

Operation:

- Switching between MAN Mode / PROG Mode (Programmable Mode)
- Operating in PROG Mode

Conditions

- Stove Plugged In
- No Thermostat Connected
- Room Sensor Connected

19 Starting the stove with each day of the week programmed: (Only applies if you followed step 18)

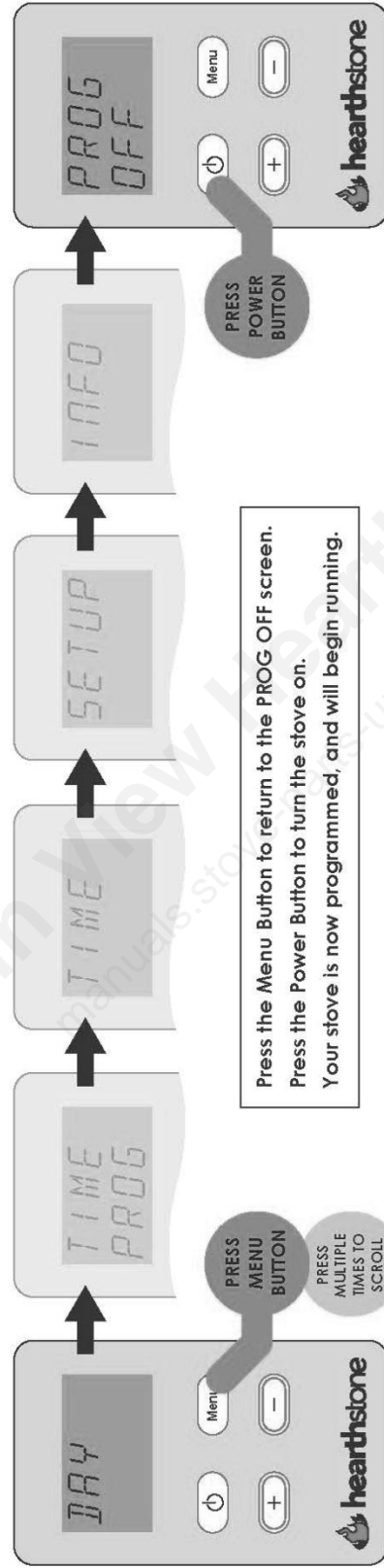

20 Setting the Home temperature:

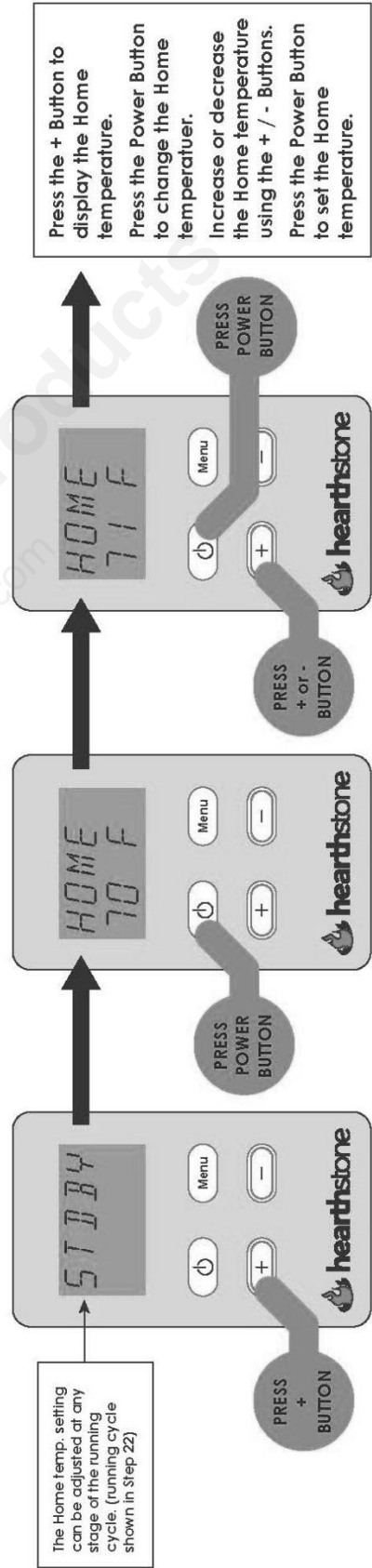

Operation:

- Switching between MAN Mode / PROG Mode (Programmable Mode)
- Operating in PROG Mode

Conditions

- Stove Plugged In
- No Thermostat Connected
- Room Sensor Connected

21 Setting the Away temperature:

The Away temp. setting can be adjusted at any stage of the running cycle. (running cycle shown in Step 22)

Press the - Button to display the Away temperature.
Press the Power Button to change the Away temperature.
Increase or decrease the Away temperature using the + / - Buttons.
Press the Power Button to set the Away temperature.

22 Running Cycle in Programmable Mode:

The stove is igniting, and climbing toward the Heat Output setting.

The stove is stopping.

The stove is in Standing by. Room temp. is satisfied.

















23 Turning off the stove:

Press the Power Button. Hold 3 SECONDS.

This indicates that the stove is OFF.

Operation

Set the Current Time/Date (Programmable Mode)

Prog 70 F	Action
time	Step 1: From the main display press  twice.
Time Set	Step 2: Press the  button to enter the Time menu.
Time 9:25	Step 3: Press the  button to enter the Time Set area.
day 21	Step 4: Use the  button to set the hour and the  button to set the minutes. Once the time is set press  to continue. <i>Note: 24 hour clock is used on this stove.</i>
Mont h	Step 5: Use the  and  buttons to change and set the current day of the month.
Year 2011	Press  to continue.
we - 1:0 -	Step 6: Use the  and  buttons to change and set the current month of the year.
Prog 70 F	Press  to continue.
	Step 7: Use the  and  buttons to change and set the current year.
	Press  to continue.
	Step 8: The current day of the week displays. Press  to confirm the date settings.

Operation

Programming the Heating Schedule (Programmable Mode)

The stove can be programmed with two different set temperatures, one home and one away. Each of these set temperatures have two different times they can be switched on. The stove can use the same Home and Away time every day of the week or they can be set differently for every day.



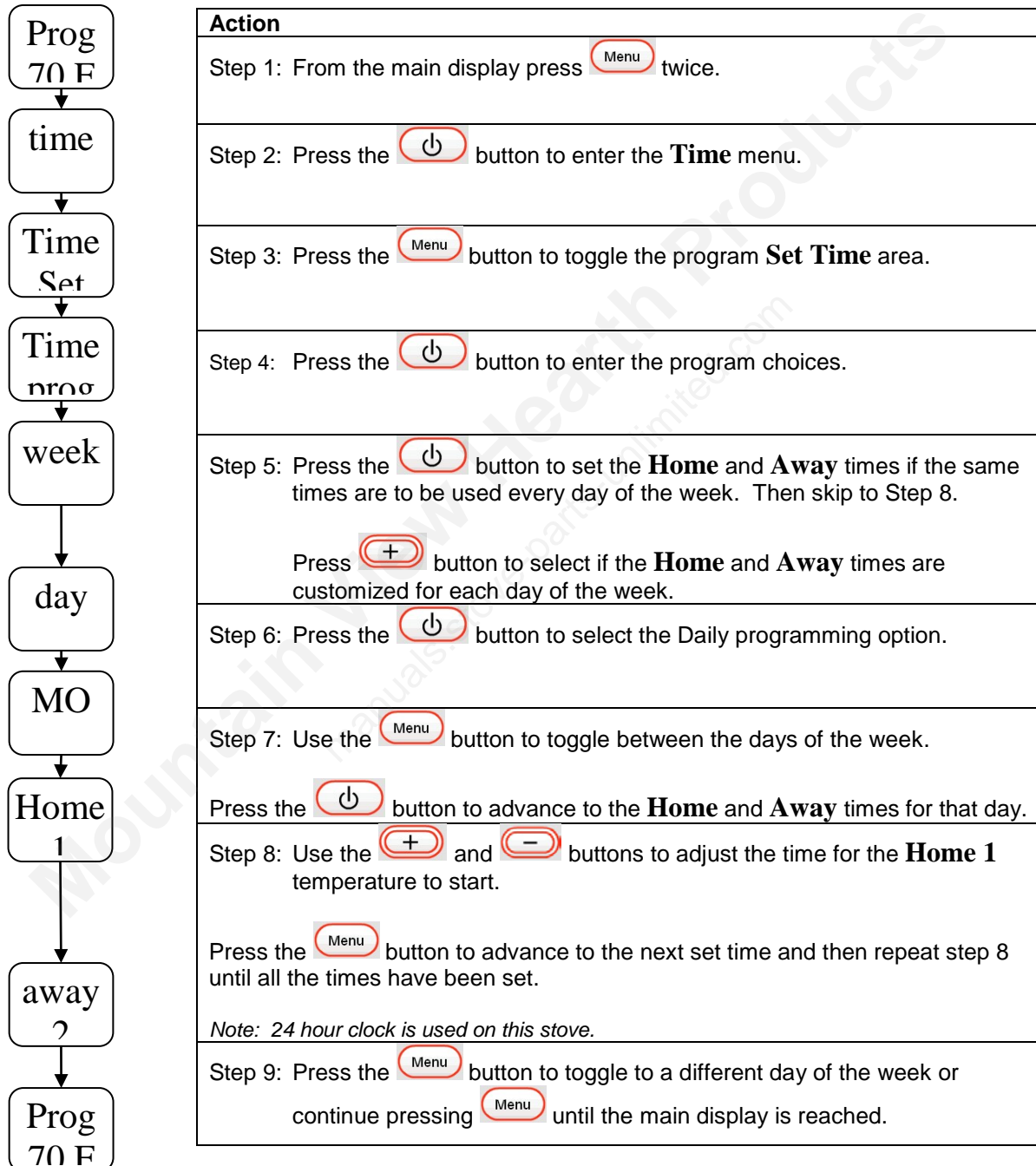



Setting the Home and Away schedule

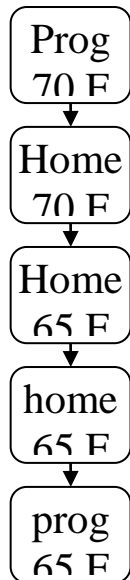

Operation

To Adjust Home and Away Temperature (Programmable Mode)



Action
Step 1: From the main display press  to view the Home set temperature or  to view the Away set temperature.
Step 2: Press the  to modify the set temperature.
Step 3: Use the  and  buttons to change the temperatures.
Step 4: Press the  button to confirm the change in the set temperature.

To Turn On or Off

Press the  button to turn the stove on and off in Programmable mode.

 Note: The stove will not ignite if the set temperature is already achieved.

Startup Cycle

All of the operation modes use the same startup cycle. Once the startup sequence is initiated, the stove does not require any user intervention. The entire sequence will take between 10 and 20 minutes depending on the starting temperature of the stove and type of pellets.

Ignition

The igniter, auger, and exhaust fan turn on immediately when the ignition phase is started. The burn pot will partially fill. The amount of filling depends on how full the auger is before the stove is started and the amount of ash and clinkers in the pot. Once the initial amounts of pellets are in the pot, the auger will stop until the pellets ignite. The unit will smoke for a few minutes as the pellets heat, shortly followed by visible flames.

The convection fan will start at the completion of the start phase. When ignition is complete, the pellets will begin to feed to maintain the fire.

Once the flame temperature in the firebox has reached a specific temperature, the unit will progress to the start phase.

Start

The start phase operates until the flame temperature sensor in the firebox reaches the normal operating temperature.

Operation

Shutdown Cycle

The display will either read **Stop** or **Off** depending on if the unit is shut down manually or from the wall thermostat / room sensor. When the shutdown process starts, the exhaust fan is switched to high.

Once the fire is fully extinguished the control will either display **OFF** or **STANDBY**.

OFF will display if the shutdown was manually initiated, or **STANDBY**, if it was turned off by either a wall thermostat or a room sensor.

Quick Cleaning Cycle

Every hour the unit enters a quick cleaning cycle. The cleaning cycle is the same for every operating mode. The cleaning cycle will last several minutes, and then the stove will return to the current operating setting. During the cleaning cycle, the feed rate of the pellets decreases and the exhaust fan speed increases.

Shutdown Cleaning Cycle

After the unit runs for five hours, it enters a more extensive shutdown cleaning cycle. The stove cleans the burn pot by stopping the pellet feed and increasing the exhaust fan speed allowing the fire to extinguish completely. Once the fire is out completely, the stove will enter a normal startup cycle.

Power Outages

The stove does not have backup power to operate during power outages. If the unit is installed with no vertical exhaust venting, it may cause smoke to backup into the room. To minimize the potential for smoke entering the room Hearthstone suggests installing the unit with a minimum of five feet of vertical venting and the use of outside air intake venting.

Once the power is restored, the stove will return to the operational setting active prior to the outage. If ignition is required, the stove will enter a special ignition procedure.

If you live in an area that experiences frequent power outages, you can use an aftermarket backup power supply for this stove, or you can use a generator. Contact your dealer for purchase options and assistance.

Frost Setting





This stove is equipped with a frost setting. To utilize the setting, the room sensor must be connected and the stove must be turned off in the Automatic or Programmable Modes. If the room temperature drops below 42°F, the stove will automatically turn on at its maximum heat output setting, and then turn off when the room reaches 55°F.

 **Note:** This unit is a supplemental heat source. It will not operate without fuel or electricity. Therefore, unattended operation time is limited. Use extreme caution with this feature.

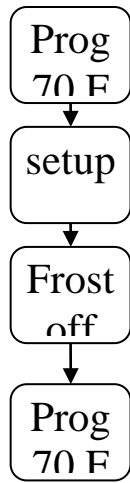
Operation

Turning On and Off the Frost Setting







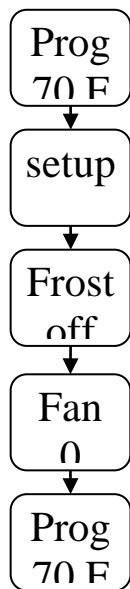

Action
Step 1: From the main display press  three times.
Step 2: Press the  button to enter the setup menu.
Step 3: Press the  button turn the frost setting on and  to turn the frost setting off.
Step 4: Continue pressing  until the main display is reached.

Adjusting the Exhaust Fan Speed

You should only adjust the exhaust fan speed if the flames have an orange, dirty look and the burn pot has to be cleaned more than once a day. If the fan speed is too high, the fire will extinguish when on the lowest burn rate, and the **No Pellets** error will appear on the display.

Changing the Exhaust Fan Speed



Action
Step 1: From the main display press  three times.
Step 2: Press the  button to enter the setup menu.
Step 3: Press  twice.
Step 4: Press the  and  buttons to adjust the fan speed faster and slower. The maximum setting is +30 and the minimum is -10.
Step 5: Continue pressing  until the main display is reached.

Ash Disposal

Disposal of Ashes – Ashes should be placed in a steel container with a tight fitting lid. Other waste shall not be placed in this container. The closed container of ashes should be placed on a noncombustible floor or on the ground, well away from all combustible materials, pending final disposal. If the ashes are disposed of by burial in soil or otherwise locally dispersed, they should be retained in the closed container until all cinders have been thoroughly cooled. Ensure you firmly seat the ash pan when ash removal is completed.

 **Note: Do not open the ash pan or front door until the stove is completely cooled.**

Maintenance

- 🔥 ALWAYS WORK ON A COOL STOVE!
- 🔥 ALWAYS DISCONNECT THE POWER BEFORE PERFORMING ANY MAINTENANCE.
- 🔥 WARNING: DO NOT USE ABRASIVE CLEANERS ON THE DOOR GLASS. SCRATCHING THE CERAMIC GLASS WILL COMPROMISE ITS STRENGTH.
- 🔥 WARNING: DO NOT CLEAN THE GLASS WHILE THE STOVE IS BURNING, OR WHEN THE GLASS IS HOT.

Proper maintenance is essential to clean and reliable performance of your Hearthstone Stove.

Your Manchester Pellet stove requires routine maintenance and care. Ensure your stove is cool to the touch and unplugged during cleaning or service. Have qualified service personnel inspect the unit and venting once a year to ensure that they are clean, free of obstruction, safe, and in good working order. If service is required, only qualified service personnel should perform it.

- 🔥 WARNING: DO NOT SUBSTITUTE MATERIALS. FOR REPLACEMENT PARTS, OR FOR INFORMATION ABOUT PARTS OR SERVICE, CONTACT YOUR LOCAL HEARTHSTONE DEALER.
- 🔥 NOTE: TURN THE UNIT OFF. ALLOW THE UNIT TO COOL. DO NOT OPEN THE ASH PAN OR FRONT DOOR UNTIL THE STOVE IS COMPLETELY COOLED.
- 🔥 Do not just drop the side doors – let them down gently! Dropping the doors will chip the enamel.

Daily

Clean burn pot

1. Open front door.
2. Check for buildup, and remove clinkers if present.
3. Remove burn pot and sweep ashes into ash pan if necessary.
4. Clean and check burn pot for wear.

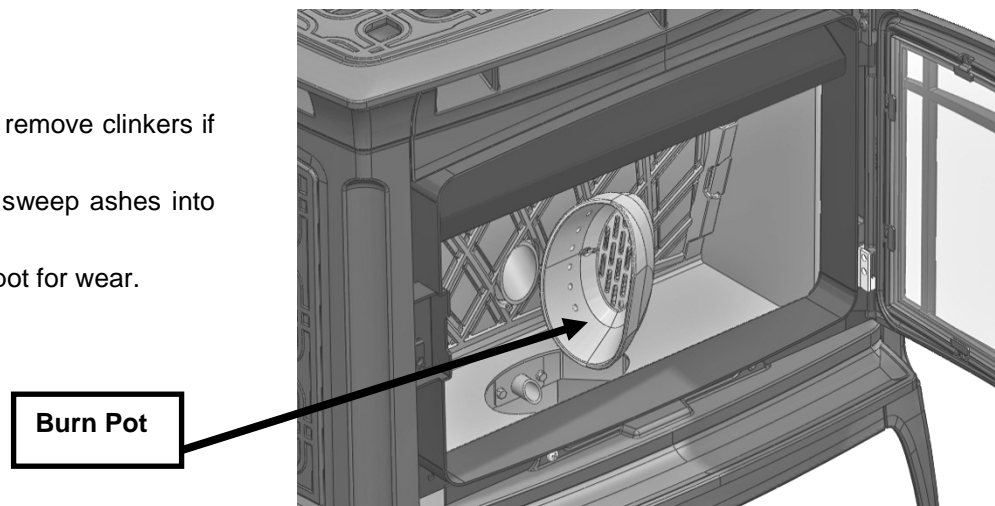

Clean heat exchanger

1. Exercise both rakes using provided maintenance tool.

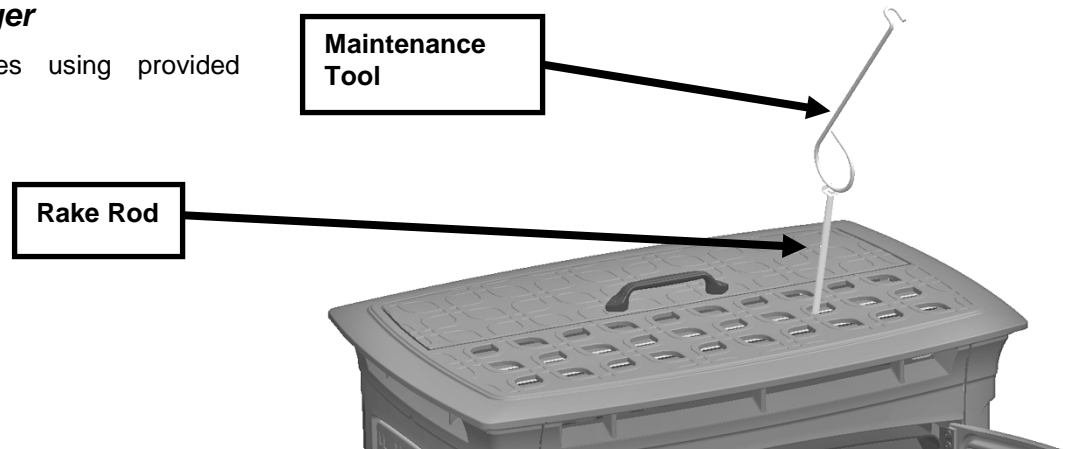

Maintenance

Weekly or as Needed

Remove ash from firebox

1. Lift burn pot, sweep ashes into ash pan or use an ash vacuum.

WARNING! USE OF A REGULAR VACUUM MAY CAUSE A FIRE.

Remove ash from ash pan

1. Remove drawer, deposit ashes in proper metal receptacle with closable lid.

Clean glass

DO NOT USE ABRASIVE CLEANERS ON THE GLASS.

1. Use glass cleaner and soft cloth, or use pellet ash and a water moistened cloth (rub lightly).

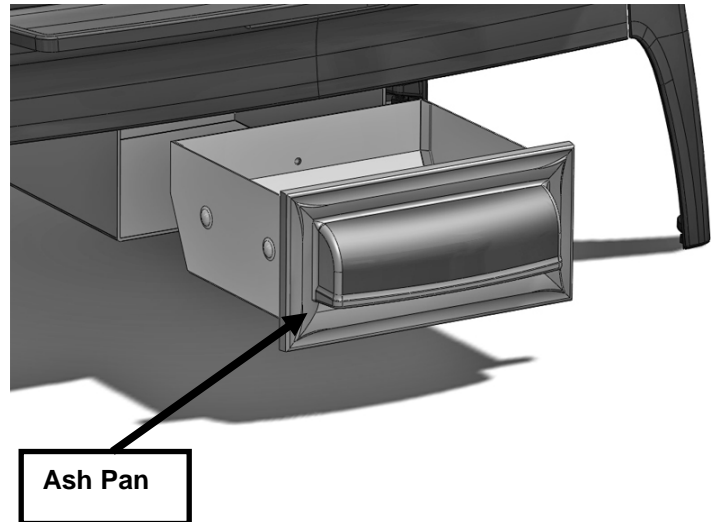

Monthly

Clean Hopper & Auger

1. Remove auger access plate inside hopper (8mm wrench or socket).
2. Vacuum any fines in hopper and auger trough.
3. Replace access plate.

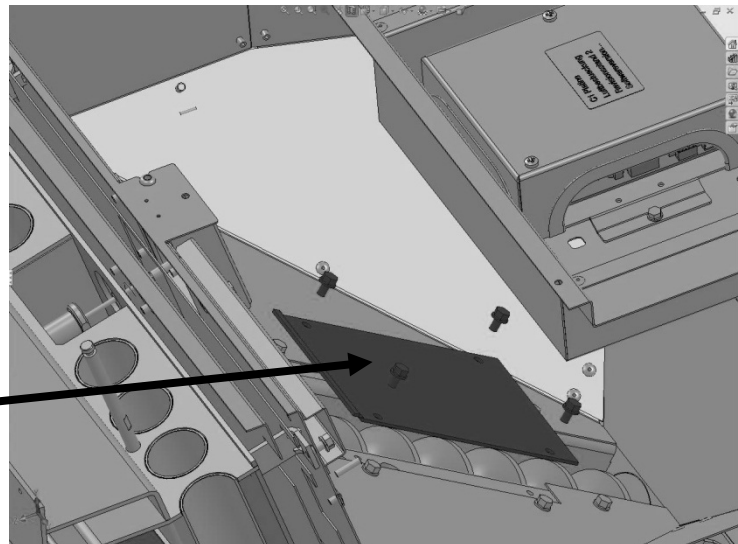

Maintenance

Yearly or Every Ton of Pellets

Clean Hopper, Auger & Exterior of Pellet Engine

1. Remove hopper door – vacuum hopper and auger inlet.
2. Remove top casting and grille assembly – vacuum all surfaces.
3. Open both side doors (using hex wrench) – **let side doors down gently!** Remove rear panel – vacuum all surfaces

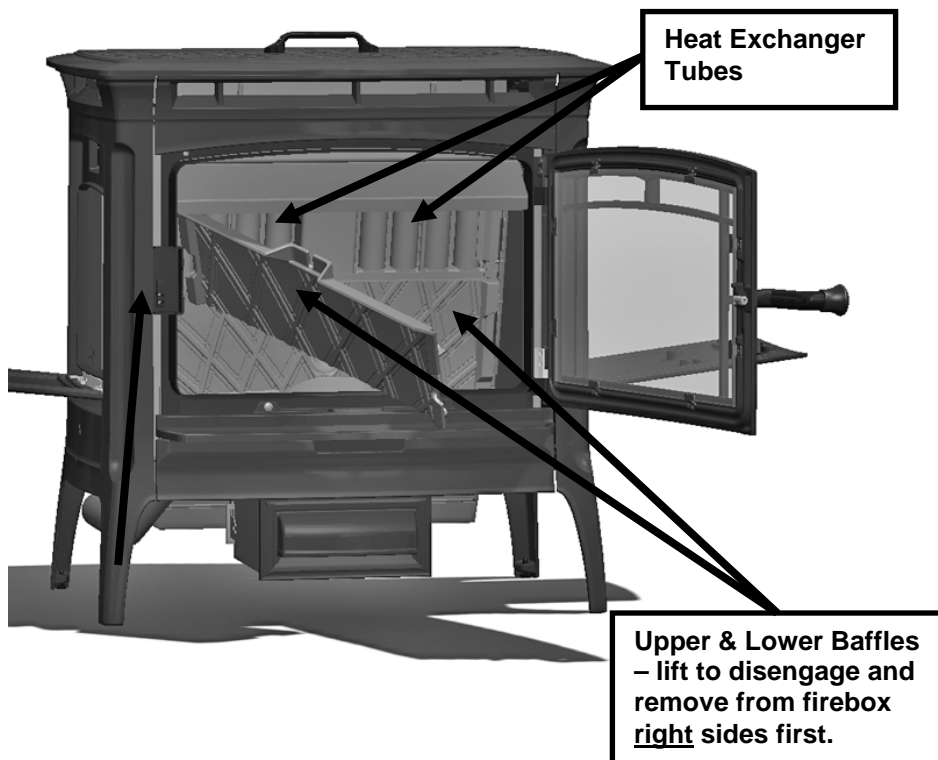
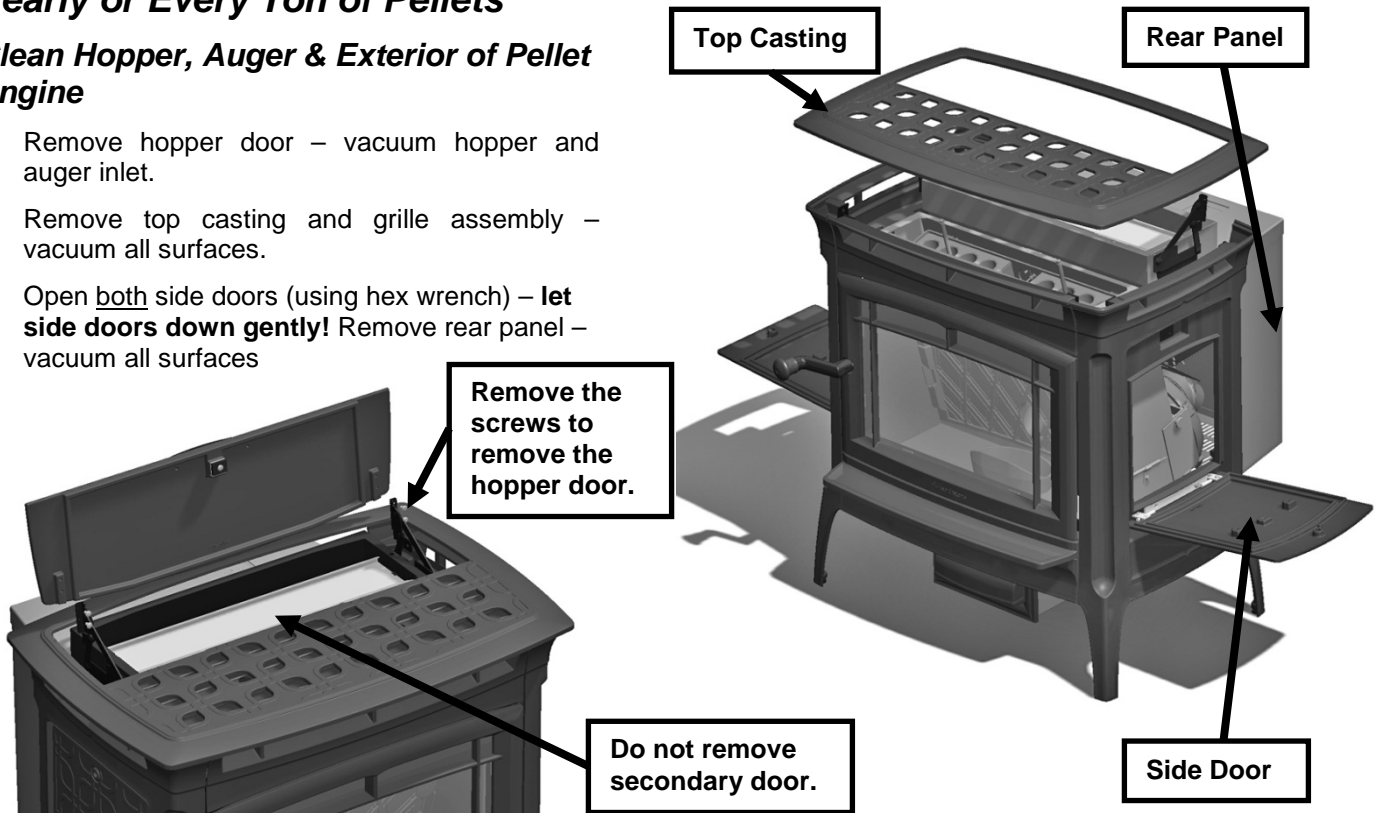

Clean Baffles & Heat Exchanger

1. Remove and clean firebox baffles. Inspect for burn through or cracking – replace as required.
2. Exercise rakes, vacuum all accessible surfaces and spaces
3. Clean convection fan impeller cage with a soft brush – vacuum as necessary.
4. You can use high temperature stove paint inside the firebox after cleaning to prevent rust during the non-heating season.

Maintenance

Clean Convection Fan

1. Remove the screen panel (4 screws) – vacuum screen and inside housing, remove any build up from fan blades with soft bristle brush.

Remove Screen.

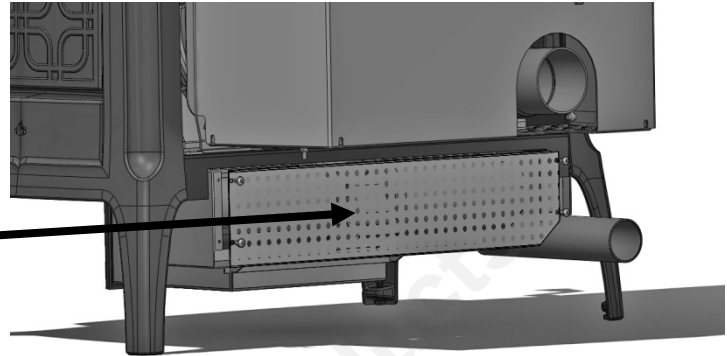

Clean Manifold

1. Remove both left and right heat exchanger access panels – vacuum inside the manifold.

Clean Exhaust Fan

2. With the access plates removed – remove any build up from exhaust fan blades with soft bristle brush.

Plate with thumbscrew (x2)

Vacuum inside on both sides of manifold

Exhaust Fan Blades

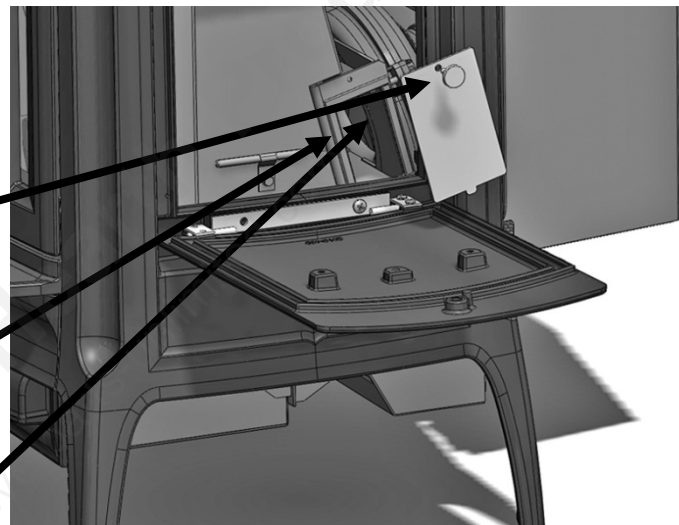

Inspect Gaskets

1. Use the Dollar bill test and check the door and ash pan gaskets for wear, replace as necessary.
 - a. Open the door, or ash pan, place a dollar bill over the gasket at various locations, close the door and pull the bill out.
 - b. If there is little or no resistance, adjust the latch tension or replace the gasket.

Inspect Venting

Soot and Flyash: Formation and Need for Removal - The products of combustion will contain small particles of flyash. The flyash will collect in the exhaust venting system and restrict the flow of the flue gases. Incomplete combustion, such as occurs during startup, shutdown, or incorrect operation of the room heater will lead to some soot formation which will collect in the exhaust venting system. The exhaust venting system should be inspected at least once every year to determine if cleaning is necessary.

1. Disassemble venting and check for ash and soot accumulation – clean as necessary.
2. Assemble flue connections - seal all connections after cleaning. Follow vent manufacturer's guidelines.

Maintenance

As Needed

External Cleaning

 **WARNING: DO NOT CLEAN THE UNIT WHEN HOT OR WHEN ANY SIGN OF COMBUSTION IS PRESENT.**

External Cleaning - The unit should receive regular cleaning on, under, and around the stove to prevent the buildup of dust and lint. Clean the exterior surfaces of the unit using soap, water, and a soft cloth. **Do not** use abrasive or chemical cleaners. Take care not to scratch the glass or enamel finish (if so equipped) when cleaning the unit. We do not recommend the use of chemical wax based cleaners or polishes due to the potential for discoloration of the castings or enamel when the residues of the cleaners or polishes are subject to heat. Excessive buildup of dust, spider webs, or room air contamination may cause odors when the stove is hot.

Maintenance

Glass Replacement Procedures

WARNING: DO NOT OPERATE THIS APPLIANCE WITH THE GLASS PANEL REMOVED, CRACKED, OR BROKEN. DO NOT SUBJECT THE DOOR TO ABUSE, SUCH AS STRIKING OR SLAMMING SHUT. ONLY A QUALIFIED SERVICE PERSON SHOULD REPLACE THE GLASS PANEL.

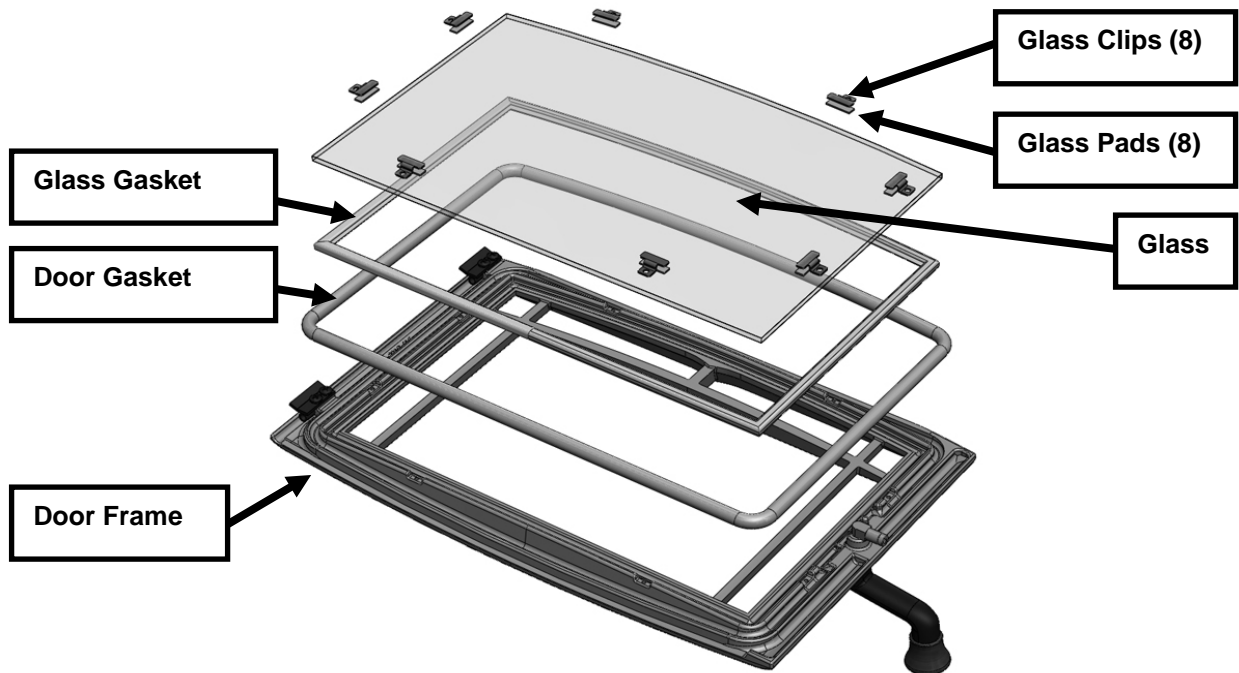

Figure 1: Front Door assembly

1. Follow the instructions included with the replacement glass kit.
2. Remove the door.
3. Remove the screws from the glass retainer (use penetrating oil if necessary) – lift the retainer off the glass. Set aside for reinstallation.
4. Carefully lift the damaged glass out of the door and discard.
5. Remove any remaining glass and old gasket material.
6. Clean the screw holes and place a small amount of anti-seize compound in each one.
7. Place the gasketed new glass onto the door. **Ensure sticker is on the exterior face of the glass.**
8. **Important! Center the glass** and ensure that the edges of the glass are parallel with the edges of the opening.
9. Check glass position again (centered, and parallel), then screw the glass retainer clips back on the door using a crisscross pattern. Tighten the screws no more than 1/8th of a turn after they seat. The glass will break at this point if not positioned correctly.
10. Apply a light film of anti-seize lubricant on the door's hinge pins if needed.
11. Install the door.
12. After 5 or 6 fires, check the glass retainer screws, and retighten if necessary.

Required Glass Kit: Part Number: 90-58901 (Glass with gasket applied). Use only 5mm Ceramic IR, or Neoceram IR glass. Contact your Hearthstone dealer.

Troubleshooting

Most errors and issues are due to a lack of required maintenance, or cleaning. Using the instructions on the following pages should resolve most issues. If an operation error is detected, the user interface flashes, and displays a message. If the message prompts the unit to shut down, a >I/O< notice will follow the text of the message. To acknowledge a message, press and hold the power button for approximately 5 seconds, if the process associated with the message is complete, the stove will return to OFF Mode. At this point, normal operation may begin again if all conditions are satisfied.

Display Messages:

Display	Problem	Possible Causes	Solution
No Pellets - (code F04)	Temperature in firebox unexpectedly dropped, or set point never reached	Pellet fuel level too low	Refill hopper
		Inferior, or wet pellets	Clean out hopper, and auger – refill with premium, dry pellets
		Auger jammed	Clean the auger. Follow the procedure in Maintenance section of this manual.
		Hopper door open	Close hopper door
No Ignition - (code F01)	Required pellet ignition temperature not achieved during startup – firebox temperature too low	Dirty Stove	Preform a Yearly Cleaning (see page 33)
		Inferior/wet pellets	Consult your Hearthstone dealer for a recommended pellet type and storage
		Auger clogged with fines	Clean auger
		Burn pot full of ash or clinkers	Clean burn pot
		Ash pan full and ashes contacting bottom of burn pot	Empty ash pan.
		Auger was completely empty and did not refill fast enough	Reset and start again. When the auger is empty, it may be necessary to add 1 cup of pellets to the burn pot prior to starting the unit.
		Front door, or ash pan open	Check both and verify they are closed completely, and sealing properly
		Hopper door is open	Close hopper door
		Blocked exhaust venting	Clean venting
		Restricted air intake, or outside air intake required.	Inspect ducting. Remove blockage. Install outside air intake
		Burn pot installed backwards	Install burn pot so ignitor hole is towards the rear of the stove
Ignitor failed	Check wiring. Replace igniter		
STb Initiated - (code F03)	Firebox/heat exchanger temperature too high	C-Fan (convection fan) setting above +5	Reset program. Do not adjust C-Fan setting.
		Convection fan not working	Service the unit.
		Convection fan clogged	Clean the convection fan. Follow the procedure in the Maintenance section of this manual.
		Top grill blocked	Remove any blockage from top of stove. Check for lint or hair on screen.

Display	Problem	Possible Causes	Solution
Flame Sensor – (code F06)	Temp sensor in firebox is malfunctioning	Flame sensor not working	Reset the unit using the power switch and contact your dealer if the problem persists.
Room Sensor – (code F07)	Communication between room sensor and stove interrupted	Room sensor unplugged	Check the rear room sensor connection at the rear of the stove or the connection on the inside of the room sensor.
		Sensor malfunction	Replace room sensor.
Too Little Air – (code F09)	Not enough air flow through firebox (monitored by sensors in inlet pipe)	The front door or ash pan open	Check both and verify that they are closed completely
		Inlet or exhaust venting blocked.	Inspect all venting. Verify there is no blockage. Clean Venting
		Excessive interior negative pressure	Install outside air inlet.
		Door gasket worn or missing	Check gasket using the dollar bill test outlined in this manual (see page 34). Replace gasket if necessary
		Exhaust blower clogged	Clean the blower. Follow the procedure in the Maintenance section of this manual.
		Dirty stove	Perform a Yearly Cleaning (see page 33)
		Poor air flow, or exhaust fan speed too slow	Replace 3" exhaust venting with 4" If everything checks, out and problem persists – increase exhaust fan speed
Cap Open	Hopper sensor not engaged. Note: The cap open error causes the auger to stop and will starve the stove for fuel if not addressed quickly.	Hopper open	Close hopper door
		Pellets on gasket seal	Clean off seal
		Hopper overfilled	Remove some pellets
		Hopper door not sitting correctly on hinges.	Check that the slots on the hopper door are fully engaged and the set screws are tight
		Sensor magnet dislodged.	Remount magnet on bottom of hopper door.
		Sensor malfunction	Replace sensor
Flue Gas Fan Faulty – (code F05)	The signal has stopped from the exhaust blower	Exhaust blower not working	Service the unit.
		Exhaust blower sensor wire disconnected	Service the unit.
		Exhaust blower clogged	Clean the exhaust blower. Follow procedure Maintenance section of this manual. Blades must move freely.

General Issues:

Problem	Possible Causes	Solution
Burn pot is overflowing.	Burn pot needs cleaning	Remove excess ashes, clinkers, and live coals from burn pot
	Ignition did not occur	Clean burn pot
		Ensure burn pot installed with ignitor hole towards rear
	Ignitor failure. Service the unit.	
Dirty stove	Preform a Yearly Cleaning (see page 33)	
Stove feeding pellets without ignition	Turn off stove. Dump pellets into ash pan. Restart stove.	
Burn pot clogs too quickly or pellets are partially burned (less than 24 hours of operation)	Poor quality or wet pellets	Consult your Hearthstone dealer for a recommended pellet type and storage
	Too much restriction in the venting	Clean intake and exhaust venting
		Increase the exhaust fan speed
		Replace 3" exhaust venting with 4"
	Excessive negative pressure in the house	Install an outside air intake.
	Burn pot is not seated correctly	Burn pot must be in direct contact with the steel surface of firebox around the perimeter of the pot. Clean floor of firebox.
	Ash pan too full and ashes contacting bottom of burn pot	Empty ash pan.
Exhaust blower clogged	Clean exhaust blower. Follow procedure in the Maintenance section of this manual.	
Fire has gone out	Room temperature satisfied (display reads STOP)	Normal operation
	Stove in a cleaning cycle (display reads CLEAN)	Normal operation
	No, or low fuel in hopper	Fill hopper with fuel
	Too much restriction in venting	Clean intake and exhaust venting
		Increase exhaust fan speed
		Replace 3" exhaust venting with 4"
	Hopper opened too long	Decrease fill time. When the hopper is open the auger does not turn which starves the fire of fuel
Auger motor or exhaust fan failure	Service the unit.	
No power to the stove	Check circuit - supply power to the unit	
Visible, or the smell of smoke	Excessive negative pressure in the house is causing exhaust vent leak, or door gasket not sealing properly	Seal venting with 500°F RTV silicone.
		Install outside air intake
		Replace gasket
	Power outage	Normal operation. Will dissipate when remaining pellets in hopper are consumed Contact you Hearthstone Dealer for battery back-up options

Problem	Possible Causes	Solution
Low heat output	Excessive soot on heat exchanger	Follow procedure in the Maintenance section of this manual.
	Poor quality, or wet pellets	Consult your Hearthstone dealer for a recommended pellet type and storage
	Dirty stove	Perform a Yearly Cleaning (see page 33)
Display not working	Stove unplugged, or electrical circuit is off	Ensure stove is plugged in to an active circuit
	Power outage	Contact your Hearthstone Dealer for battery back-up options
	Connection between mother board and display not working	Check fuse on back of stove
		Check wire connections between mother board and display
Display malfunction	Replace display	

Replacement Parts & Optional Accessories List

PART NUMBER:	DESCRIPTION:	PART NUMBER:	DESCRIPTION:
CASTINGS:*		GASKETS:	
2010-915	ASH DOOR	3110-056	GASKET: ROPE, 1/4", BLK, AD
2010-997	HOPPER DOOR HANDLE	3110-057	GASKET: ROPE, 3/8", AD, NON-CORE
2310-300	TOP	3120-021	GASKET: GLASS CLIP
2310-305	HOPPER DOOR	3160-070	GASKET: TAPE 5/8" X 1/4"
2310-310	FRONT DOOR FRAME	3160-080	GASKET: TAPE, 3/4"x1/16", AD
2310-615	FRONT DOOR	3160-390	GASKET: FEEDER TUBE
2310-617	FRONT OR SIDE DOOR HANDLE	3160-391	GASKET: CONTROL BOARD
			GASKET: 3/8" X 1/8" FLAT KNIT BLK
2310-620	SIDE DOOR	3160-392	1/4" AD SP
2310-645	SIDE: WITH DOOR OPENING	3160-396	GASKET: MTR HOUSING KNOCKOUT
2310-650	FRONT GRILL	3160-397	GASKET: INLET TUBE
2310-655	ASH PAN DOOR HANDLE		
2310-660	ASH LIP	MISC:	
2910-000	BURN POT	3900-187	WOOD HANDLE
2910-005	BAFFLE: UPPER	4700-0795	MAGNET
2910-010	BAFFLE: LOWER	5090-080	SERVICE TOOL
		6400-40468	OWNER'S MANUAL
STEEL:		3120-220	UPPER BAFFLE CERAMIC HEATSHIELD
5090-011	PAN: ASH	3120-221	LOWER BAFFLE CERAMIC HEATSHIELD
5090-016	FRAME: OUTER ASH BOX	3200-101	SATIN BLACK HIGH TEMP PAINT
5090-069	SCREEN: OUTLET GRILL	7000-037	WIRE HARNESS
5090-070	LOUVER: CIRCULATION AIR	7211-951	CONVECTION FAN ASSY
5330-025	HINGE: HOPPER DOOR, LEFT	7211-967	EXHAUST FAN MOTOR
5330-026	HINGE: HOPPER DOOR, RIGHT	7211-970	AUGER MOTOR
5330-030	DOOR: SECONDARY HOPPER	7300-000	MOTHER BOARD
5330-035	AIR WASH,	7300-005	AIR FLOW SENSOR
5330-040	HOPPER: CABLE CHANNEL,	7300-010	CONTROL BOARD
5330-045	ROD: HEAT EXCHANGER CLEANING	7300-015	IGNITER ELEMENT
5360-050	HINGE: FRONT DOOR, WITH PIN	7300-020	HOPPER SAFETY SENSOR
5360-058	HINGE: SIDE DOOR	7300-025	TEMP SAFETY LIMIT SWITCH
5360-060	CLIP: SIDE DOOR HINGE	7300-030	FLAME SENSOR THERMOCOUPLE
5360-062	HINGE: FRONT DOOR		
5240-145	ASH PAN CATCH SPRING	KITS:	
5240-146	ASH PAN CATCH KNOB	90-56925	WIRED ROOM SENSOR KIT
5532-012	PALLET MOUNTING CLIP	90-58901	GLASS KIT
5909-061	AIR INLET PIPE	90-70900	HOPPER DOOR SUPPORT KIT
5909-070	HOUSING: EXHAUST FAN	90-73901	FRONT DOOR HANDLE KIT
		90-76900	LOWER BAFFLE KIT
		90-76901	UPPER BAFFLE KIT

* Part numbers: use 2010 for Matte, 2020 for Brown Majolica.

Manchester Pellet Stove Model 8330.

Manufactured and Warranted by:

Hearthstone Quality Home Heating Products, Inc.
317 Stafford Ave,
Morrisville, VT 05661
www.hearthstonestoves.com

Safety Label

CONTACT YOUR LOCAL BUILDING RESTRICTIONS AND INSTALLATION OR FIRE OFFICIALS ABOUT INSPECTION IN YOUR AREA
Listed Room Heater, Pelletized Fuel Type

Also Suitable for Mobile Home Installation Pursuant to (UM)84-HUD

Tested & Listed by / Testé et Certifié par:

Manufactured by / Manufacturé par:



317 Stafford Ave., Morrisville, VT 05661, USA

SERIAL #

NO SÉRIE

MODEL NAME: MANCHESTER 8330

TESTED TO: ASTM E1509-04,
ULC/ORD C1482-M1990,
ULC S627-00

REPORT #: 261-S-04b-2

Type of Fuel: For Use With Pelletized Wood Fuel Only

The use of other fuels may damage the unit.

Electrical Rating: 120 V, 4 A, 60 Hz

Input Rating: 15,300 to 51,000 BTU Typical

Note: Replace glass only with 5mm Ceramic IR or Neoceram IR glass.

Components required for residential and mobile home installation: Listed 3" or 4" Pellet Vent.

DANGER: Risk of electrical shock. Disconnect power before servicing unit. Do not route power cord beneath heater.

WARNING: Do not obstruct the space beneath the heater.

NOTE: Do not open the ash pan or front door until the stove has cooled completely.

"PREVENT HOUSE FIRES"
Install and use only in accordance with manufacturer's installation instructions and your local building codes.

CAUTION: Special methods are required when passing chimney through a wall or ceiling. Follow the pipe manufacturer's instructions and local building codes for the clearance to combustibles required for the installation of the vent pipe being used. Do not pass chimney connector through a combustible surface. Do not connect this unit to a chimney flue serving another appliance. If not using an outside air inlet for combustion a source of fresh air must be provided to the room.

Room Heater, Pellet Fuel-Burning Type, Also For Use In Mobile Homes.

WARNING: (MOBILE HOME)

An outside air inlet must be provided for combustion and be unrestricted while unit is in use.

Clearance to Combustible Materials

Refer to the Manual for additional clearance and operation information.

Noncombustible Floor Protection

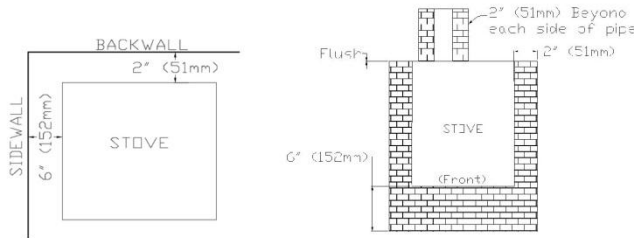

CAUTION

- Hot while in operation.
 - Do not touch, keep children, clothing, and furniture away.
 - Contact may cause skin burns.
- See name plate and instructions.

DO NOT OVER-FIRE. IF HEATER OR CHIMNEY CONNECTOR GLOWS, YOU ARE OVER-FIRING. INSPECT AND CLEAN CHIMNEY AND CONNECTOR FREQUENTLY. UNDER CERTAIN CONDITIONS OF USE, FLY ASH BUILDUP MAY OCCUR RAPIDLY. MOVING PARTS MAY CAUSE INJURY.

CAUTION: OPERATE THIS UNIT ONLY WITH THE FUEL HOPPER LID CLOSED. FAILURE TO DO SO MAY RESULT IN EMISSIONS OF PRODUCTS OF COMBUSTION FROM THE HOPPER UNDER CERTAIN CONDITIONS. MAINTAIN HOPPER SEAL IN GOOD CONDITION. DO NOT OVERFILL THE HOPPER.

WARNING: RISK OF SMOKE AND FLAME SPILLAGE, KEEP VIEWING AND ASH REMOVAL DOORS TIGHTLY CLOSED DURING OPERATION.

U.S. ENVIRONMENTAL PROTECTION AGENCY
Certified to comply with July 1990 particulate emission standards.

DATE OF MANUFACTURE / DATE DE FABRICATION

2011 2012 2013 JAN FEB MAR APR MAY JUN JUL AUG SEP OCT NOV DEC

DO NOT REMOVE OR COVER THIS LABEL

3300-215 REV B

Customized Set Up Data:

Mountain View Hearth Products
manuals.stove-parts-unlimited.com