

PLEASE KEEP THESE INSTRUCTIONS FOR FUTURE REFERENCE

SARATOGA

PELLET STOVE OWNER'S MANUAL



**Contact your building or fire officials about restrictions and
Installation inspection requirements in your area.**

**PLEASE READ THIS ENTIRE MANUAL BEFORE INSTALLATION AND USE OF
THIS PELLET BURNING ROOM HEATER. FAILURE TO FOLLOW THESE
INSTRUCTIONS COULD RESULT IN PROPERTY DAMAGE, BODILY INJURY,
OR EVEN DEATH.**

Introduction

PELLET QUALITY IS IMPORTANT; PLEASE READ THE FOLLOWING:

Your pellet stove has been designed to burn wood pellets only. Do not use any other type of fuel, as this will void any warranties stated in this manual.

The performance of your pellet stove is greatly affected by the type and quality of wood pellets being burned. As the heat output of various quality wood pellets differs, so will the performance and heat output of the pellet stove.

CAUTION: It is important to select and use only pellets that are dry and free of dirt or any impurities such as high salt content. Dirty fuel will adversely affect the operation and performance of the unit and will void the warranty. The Pellet Fuel Industries (P.F.I.) has established standards for wood pellet manufacturers. We recommend the use of pellets that meet or exceed these standards. Please use a recommended pellet type.

P.F.I. PELLET STANDARDS:

Fines (fine particles).....	1% maximum through a 1/8" screen
Bulk Density.....	40 pound per cubic foot minimum
Size.....	1/4" to 5/16" diameter 1/2 – 1 1/2" long maximum Ash
Content.....	1% maximum (Premium grade)
3% maximum (Standard grade)
Moisture Content.....	8% maximum
Heat Content.....	approximately 8200 Btu per pound minimum

ASH: The ash content of the fuel and operation of your stove will directly determine the frequency of cleaning. The use of high ash fuels may result in the stove needing to be cleaned daily. A low ash fuel may allow longer intervals between cleaning.

CLINKERING: [clinkers are silica (sand) or other impurities in the fuel that will form a hard mass during the burning process]. This hard mass will block the airflow through the Burn Pot Liner and affect the performance of the stove. Any fuel, even approved types, may tend to clinker. Check the Burn-Pot Liner daily to ensure that the holes are not blocked with clinkers. If they become blocked, remove the liner (when the unit is cold) and clean/scrape the clinkers out. Clean the holes with a small pointed object if required. Refer to the section Routine Cleaning and Maintenance.

PELLET FEED RATES: Due to different fuel densities and sizes, pellet feed rates may vary. This may require an adjustment to the slider damper setting or to the auger feed trim setting on low.

Since stove supplier has no control over the quality of pellets that you use, we assume no liability for your choice in wood pellets.

Store pellets at least 36" (1 m) away from the pellet stove.

IMPORTANT SAFETY DATA:

Please read this Owner's Manual before installing or operating your Pellet Stove. Failure to follow these instructions may result in property damage, bodily injury or even death. Contact your local building or fire official to obtain a permit and any information on installation restrictions and inspection requirements for your area.

To prevent the possibility of a fire, ensure that the appliance is properly installed by adhering to the installation instructions. The dealer will be happy to assist you in obtaining information with regards to your local building codes and installation restrictions.

Be sure to maintain the structural integrity of the home when passing a vent through walls, ceilings, or roofs.

The stove's exhaust system works with negative combustion chamber pressure and a slightly positive chimney pressure. It is very important to ensure that the exhaust system be sealed and airtight. The ash pan and viewing door must be locked securely for proper and safe operation of the pellet stove.

Do not burn with insufficient combustion air. A periodic check is recommended to ensure proper combustion air is admitted to the combustion chamber. Setting the proper combustion air is achieved by adjusting the slider damper located on the left side of the stove.

When installing the stove in a mobile home, it must be electrically grounded to the steel chassis of the home and bolted to the floor. Make sure that the structural integrity of the home is maintained and all construction meets local building codes.

Minor soot or creosote may accumulate when the stove is operated under incorrect conditions such as an extremely rich burn (black tipped, lazy orange flames).

If you have any questions with regard to your stove or the above-mentioned information, please feel free to contact your local dealer for further clarification and comments.

SAFETY WARNINGS AND RECOMMENDATIONS:

Caution: Do not connect to any air distribution duct or system.

Do not burn garbage or flammable fluids such as gasoline, naphtha or engine oil.

Unit is hot while in operation. Keep children, clothing and furniture away. Contact may cause skin burns.

FUEL: This pellet stove is designed and approved to only burn wood pellet fuel with up to 3% ash content. Dirty fuel will adversely affect the operation and performance of the unit and may void the warranty. Check with your dealer for fuel recommendations.

THE USE OF CORDWOOD IS PROHIBITED.

SOOT: Operation of the stove with insufficient combustion air will result in the formation of soot which will collect on the glass, the heat exchanger, the exhaust vent system, and may stain the outside of the house. This is a dangerous situation and is inefficient. Frequently check your stove and adjust the slider/damper as needed to ensure proper combustion. **See: "SLIDER/DAMPER SETTING".**

CLEANING: There will be some build up of fly ash and small amounts of creosote in the exhaust. This will vary due to the ash content of the fuel used and the operation of the stove. It is advisable to inspect and clean the exhaust vent semi-annually or every two tons of pellets.

Introduction

ASHES: Disposed ashes should be placed in a metal container. The closed container of ashes should be on a non-combustible floor on the ground, well away from all combustible materials pending final disposal. If the ashes are disposed of by burial in soil or otherwise locally dispensed, they should be retained in the closed container until all cinders have been thoroughly cooled. Other waste should not be placed in the same container as ashes.

ELECTRICAL: The use of a surge protected power bar is recommended. The unit must be grounded. The grounded electrical cord should be connected to a standard **115 volts (4.5 Amps), 60 hertz electrical outlet, or 1015 volts (4.5 Amps), 60 hertz electrical outlet.** Be careful that the electrical cord is not trapped under the appliance and that it is clear of any hot surfaces or sharp edges and also must be accessible. If this power cord should become damaged, a replacement power cord must be purchased from the manufacture or a qualified dealer. **The stove's maximum power requirement is 520 watts.**

GLASS: Do not abuse the glass by striking or slamming the door. Do not attempt to operate the stove with broken glass. The stove uses ceramic glass. Replacement glass must be purchased from a qualified dealer. Do not attempt to open the door and clean the glass while the unit is in operation or if glass is hot. To clean the glass, use a soft cotton cloth and mild window cleaner, gas or wood stove glass cleaner, or take a damp paper towel and dip into the fly ash. This is a very mild abrasive and will not damage the glass. Do not use any abrasive cleaners on the glass.

FLAMMABLE LIQUIDS: Never use Flammable Liquid such as gasoline, gasoline-type lantern fuel, kerosene, charcoal lighter fluid, or similar liquids to start or "freshen up" a fire in the heater. Keep all such liquids well away from the heater while it is in use.

SMOKE DETECTOR: Smoke detectors should be installed and maintained in the structure when installing and operating a pellet burning appliance.

OPERATION: The ash pan and door must be closed securely for proper and safe operation of the pellet stove. Also ensure all gaskets on the door are checked and replaced when necessary.

KEEP ASH PAN FREE OF RAW FUEL.

DO NOT PLACE UNBURNED OR NEW PELLET FUEL IN ASH PAN. A fire in the ash pan may occur.

INSTALLATION: Be sure to maintain the structural integrity of your home when passing a vent through walls, ceilings, or roofs. It is recommended that the unit be secured into its position in order to avoid any displacement.

DO NOT INSTALL A FLUE DAMPER IN THE EXHAUST VENTING SYSTEM OF THIS UNIT.

DO NOT CONNECT THIS UNIT TO A CHIMNEY FLUE SERVING ANOTHER APPLIANCE.

FRESH AIR: Outside Fresh Air connection is optional. Must be connected to all units installed in Mobile and "Air Tight Homes" (R2000) or where required by local codes. Consider all large air moving devices when installing your unit and provide room air accordingly. Limited air for combustion may result in poor performance, smoking and other side effects of poor combustion.

If you have any questions with regards to your stove or the above-mentioned information, please feel free to contact your local dealer for further clarification and comments.

SINCE STOVE SUPPLIER HAS NO CONTROL OVER THE INSTALLATION OF YOUR STOVE, STOVE SUPPLIER GRANTS NO WARRANTY IMPLIED OR STATED FOR THE INSTALLATION OR MAINTENANCE OF YOUR STOVE. THEREFORE, STOVE SUPPLIER ASSUMES NO RESPONSIBILITY FOR ANY CONSEQUENTIAL DAMAGE(S).

SAVE THIS INSTRUCTION MANUAL FOR FUTURE REFERENCE!

AUTOMATIC SAFETY FEATURES:

Your pellet Stove has the following safety features:

- A. The stove will shut off when the fire goes out and the exhaust temperature drops below 120°F(52°C).
- B. The stove has a high temperature safety switch. If the temperature on the hopper reaches 200°F (93°C), the auger will automatically stop and the stove will shut down when the exhaust temperature cools. If this happens, call your local dealer to reset the 200°F (93°C) high limit switch. **ALSO FIND THE REASONS WHY THE UNIT OVERHEATED.**
- C. If the power goes out, the unit will stop running. When the power comes back on, the stove will not restart unless the exhaust temperature is still above 120°F (52 °C).

Product performance introduction

Pellet stove is advanced designed and has individual fresh air input and venting system. Negative pressure burning technology causes high efficiency and little ash outlet during burning. It will be shut off automatically by wrong burning or out of fuel. Large BTU, quick heating and low fuel cost are its advantages.

1. Main performance

Model	SARATOGA
Rating input BTU/h	30000 BTU
Heating area	2000 SQUARE FEET
Rating voltage V	115
Rating frequency Hz	60
Rating power W	< = 150
Hopper	45 LBS
Venting pipe diameter	3 INCH
Air input pipe diameter	2 INCH
Unit size (wide* depth*high)	18 ¼" W X 20 ¾" D X 34" H

Stove Clearances

The following minimum clearances to combustibles must be maintained. Keep all combustibles at least 18" (horizontally) away from the glass windows.

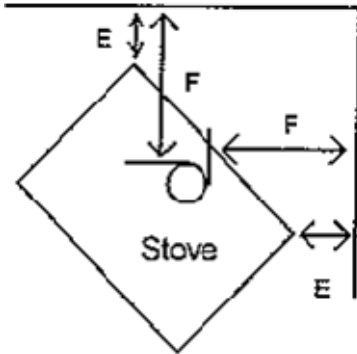

E 2"

F 1"

ALCOVE CONFIGURATION

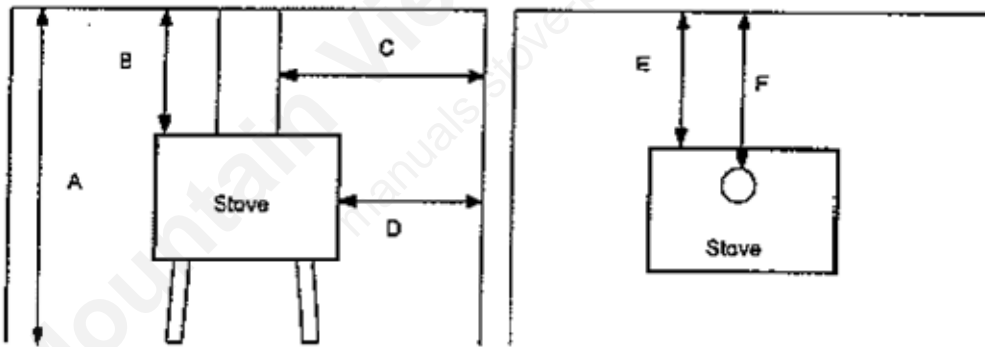

A 47"

B 13.5"

C 7.5"

D 4"

E 9"

F 1"

Installation

Deciding Where to Locate your Pellet Appliance:

When installing this unit on a combustible floor (for example linoleum, hardwood flooring) a non-combustible hearth pad (3/8" thickness) must be under the unit. The pad must extend at least the width of the appliance and at least the depth of the appliance plus 6" in front of the appliance.

Floor Protection

Your pellet stove must be installed on a non-combustible protective floor pad of minimum 3/8" thickness material or a masonry hearth. The hearth or floor pad must extend a minimum of 6" in front of and from each side of the stove or to the nearest permitted combustible material if less than 6".

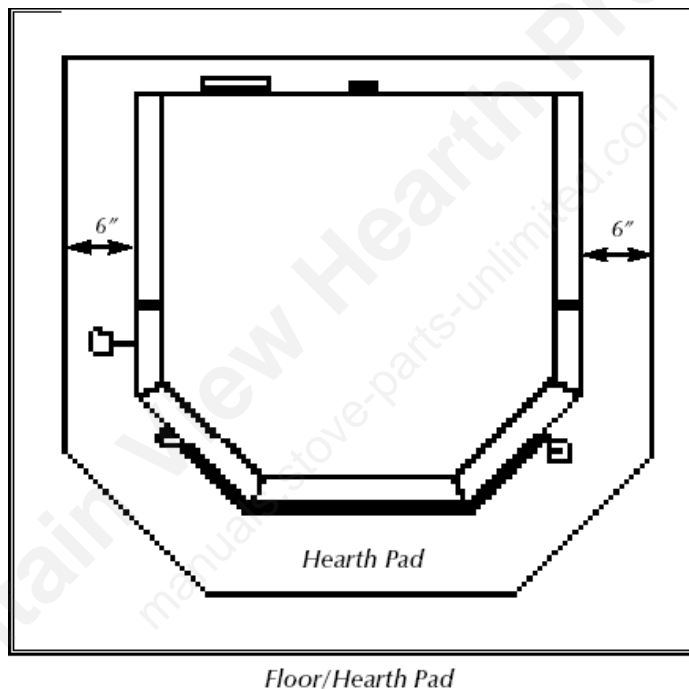

STOVE DIMENSIONS: 18 1/4" W X 20 3/4" D X 34" H

VENTING

PELLET VENT MUST MAINTAIN A MINIMUM 3" CLEARANCE TO ANY COMBUSTIBLE (install vent at clearances specified by the vent manufacturer).

Must be an approved 3" or 4" Diameter Type "L" or "PL" vent, vented to the outside or connect the vent to a factory built type "A" chimney using an adaptor; and/or stainless steel chimney liner for masonry fireplace installations. Use 4" diameter vent if vent or liner height is over 15' or if installation is over 4,000' above sea level. When passing through a wall, or partition of combustible construction the installation shall conform to CAN/CSA-B365.

MAXIMUM VENTING:

The vent must have a support bracket every 5' when on the exterior wall. To achieve optimum performance, keep vent runs as short as possible, especially on horizontal installations. Maximum venting height is 33'. Maximum horizontal offset is 10'. Use no more than 180° of elbows (two 90° elbows, or two 45° elbows and one 90° elbow, etc), plus termination.

VENT INSTALLATION:

Termination must exhaust above the air inlet elevation and parallel or above the exhaust output of the pellet appliance. It is recommended that at least 3' of vertical pipe be installed to create some natural draft. This is to help prevent the possibility of smoke or odor during the appliance shut down or in the event of a power outage. Horizontal sections must have a 1/4" rise every 12" of travel if longer than 3'. The pellet vent connections must be sealed with HI-Temp RTV Silicone and screwed together with at least 3 3/8" long stainless steel screws. Seal each vent section by injecting a liberal amount of 500°F (260°C) RTV silicone sealant into the gap. We recommend sealing the outside of the vent connections to permit easier access when servicing

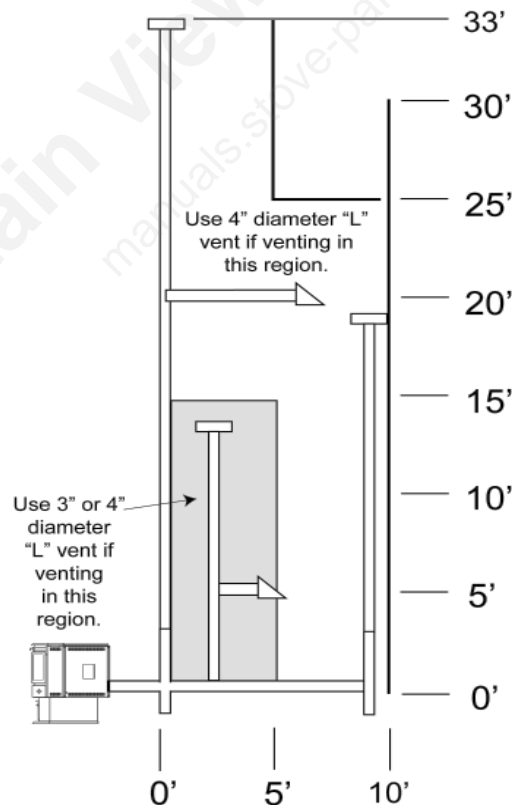

VENTING (CONTINUED)

DO NOT INSTALL A FLUE DAMPER IN THE EXHAUST VENTING SYSTEM OF THIS UNIT. DO NOT CONNECT THIS UNIT TO A CHIMNEY FLUE SERVING ANOTHER APPLIANCE.

Installation Configurations

HORIZONTAL EXHAUST VENT INSTALLATION

1. Locate your appliance in a location which meets the requirements of this manual and where it does not interfere with the house framing, wiring, etc..
2. Install a non-combustible hearth pad underneath the unit. This pad should extend at least 6" (152 mm) in front of the unit, and 6" to the left and right sides of the unit.
3. Place the stove approximately 15" (381 mm) away from the interior wall.
4. Locate the center of the exhaust pipe of your unit. This point should then be extended to the interior wall of your house. Once you have located the center point, on the interior wall, cut a 7" (175 mm) diameter hole through the wall.
5. The next step is to install the wall thimble, refer to the instructions which come with the wall thimble for this step.
6. Install the appropriate length of exhaust vent pipe into the wall thimble. See step 11 when determining the correct length of exhaust vent to use.
7. Install the combustion air intake pipe (if applicable). Be sure that the outside air vent has a proper cap on it to prevent rodents from entering and also is installed where it won't become blocked with snow, etc..
8. Connect the exhaust vent pipe to the exhaust outlet of your appliance.
9. Secure all vent joint connections with 3 screws. Seal the exhaust vent joint connections with high temperature silicone sealant.
10. Push the unit straight back to the interior wall but be sure to maintain the minimum clearances to combustibles 6" (152 mm) to the back of the unit. Seal the annular space, of the wall thimble, around the vent pipe with high temperature silicone sealant.
11. The exhaust vent pipe must extend at least 12" (300 mm) out past the exterior wall. Seal the annular space, of the wall thimble, around the vent pipe with high temperature silicone sealant.
12. Install a listed horizontal termination cap or if necessary install a 90° elbow and appropriate length of vertical venting. A listed vertical vent cap is recommended however (if local codes allow) when the vent terminates several feet above ground level and there are no trees, plants, etc. within several feet a 45° elbow can be used as a termination. The elbow must be turned down to prevent rain from entering.

Standard Horizontal Installations

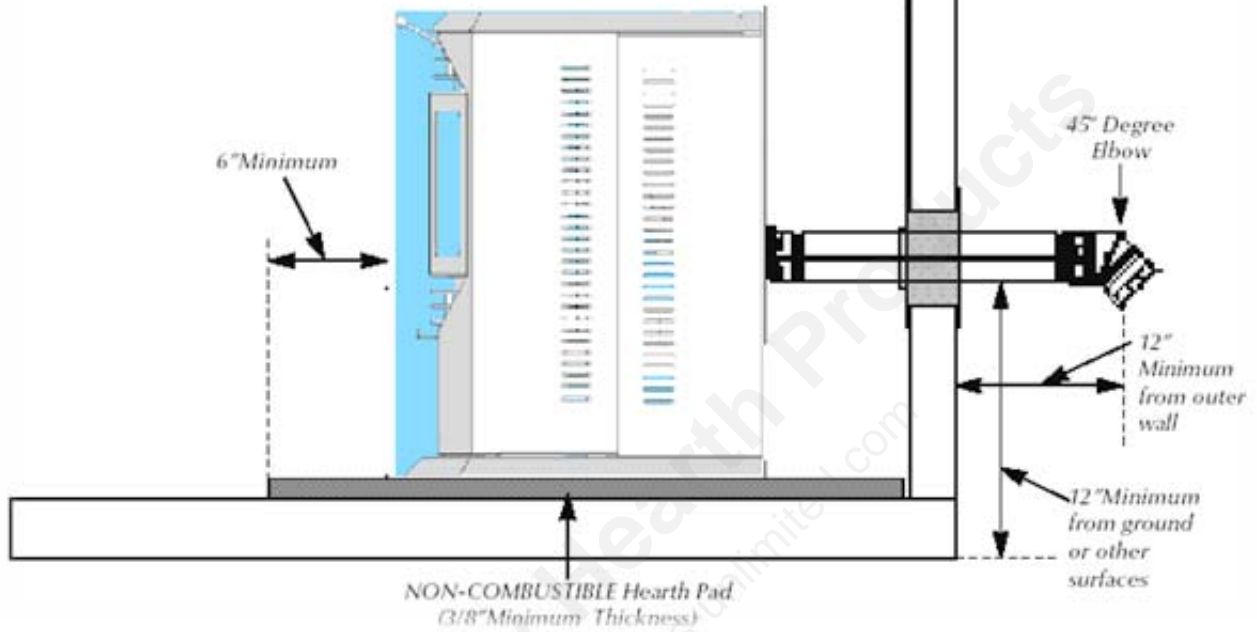

Standard Horizontal Installations

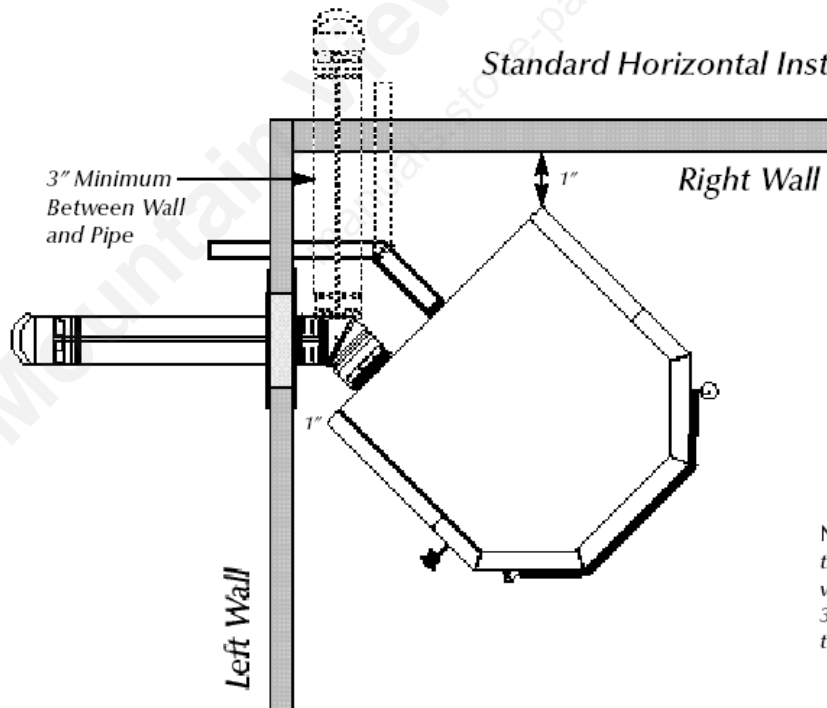

NOTE: If you vent to the Right Wall, the vent pipe must maintain a 3" clearance parallel to the left wall.

Installation Configurations (Cont'd)

FREESTANDING INTERIOR VERTICAL INSTALLATION

1. Choose the location for your pellet stove, see item 1 of the Horizontal Exhaust Vent Installation (page 16) for help in determining the correct location.
2. Install the non-combustible hearth pad.
3. Place your pellet stove on the hearth pad and locate the unit in manner that will leave the exhaust vent with a minimum of 3" (75 mm) clearance to any combustible wall.
4. Locate the center of the combustion air intake pipe at the back of your unit. Line up the center with the same spot on your exterior wall and cut a hole 2-1/2" (64 mm) in diameter through the wall.
5. Secure all vent joint connections with 3 screws. Seal the exhaust vent joint connections with high temperature silicone sealant.
6. Install the optional combustion air intake pipe.
7. Install a tee, with a cleanout, on the exhaust pipe found at the rear of your unit.
8. Install listed vent upward through the ceiling. When you pass through the combustible framing ensure that the appropriate ceiling is used. You must maintain a minimum 3" (75 mm) clearance to combustibles and keep any insulation away from the exhaust vent.
9. Extend the exhaust vent through the roof flashing and ensure that the vertical cap is approximately 36" (900 mm) above the roof.

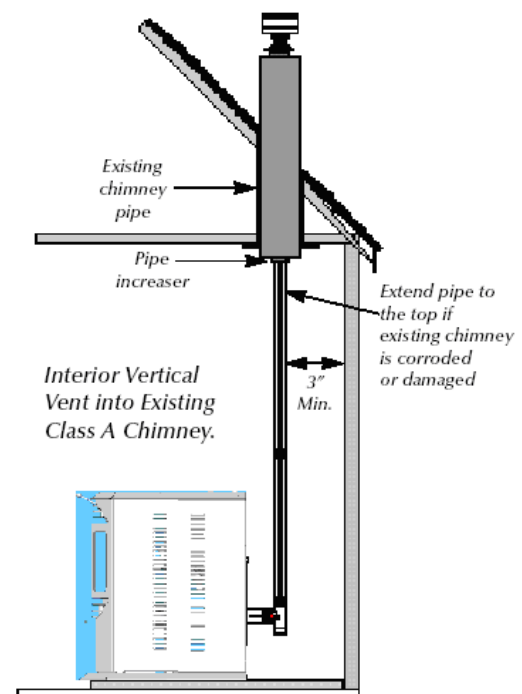
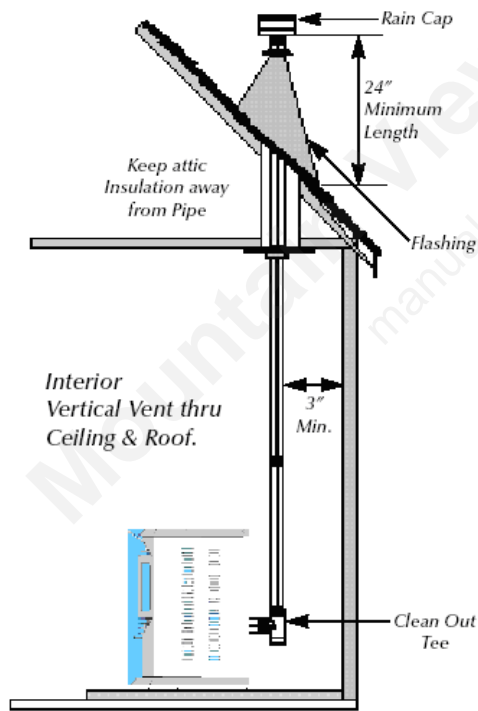

FREESTANDING EXTERIOR VERTICAL INSTALLATION

1. Follow steps 1 – 5 from previous page.
2. Locate the center of the exhaust pipe, at the back of the unit. Line up the center with the same spot on the exterior wall a cut a 7" (175 mm) diameter hole through the wall.
3. Install the wall thimble, refer to the instructions which come with the wall thimble for this step.
4. Install a listed exhaust vent through the wall, be sure to make sure that 3" (75 mm) clearances to combustibles are maintained.
5. Secure all vent joint connections with 3 screws. Seal the exhaust vent joint connections with high temperature silicone sealant.
6. Install a Tee with a cleanout on the end of the exhaust pipe, then install listed venting upward from there. Be sure to install support brackets every 5' (1500 mm) to keep the venting straight and secure.
7. Extend the exhaust vent through the roof flashing and ensure that the vertical cap is approximately 36" (900 mm) above the roof.

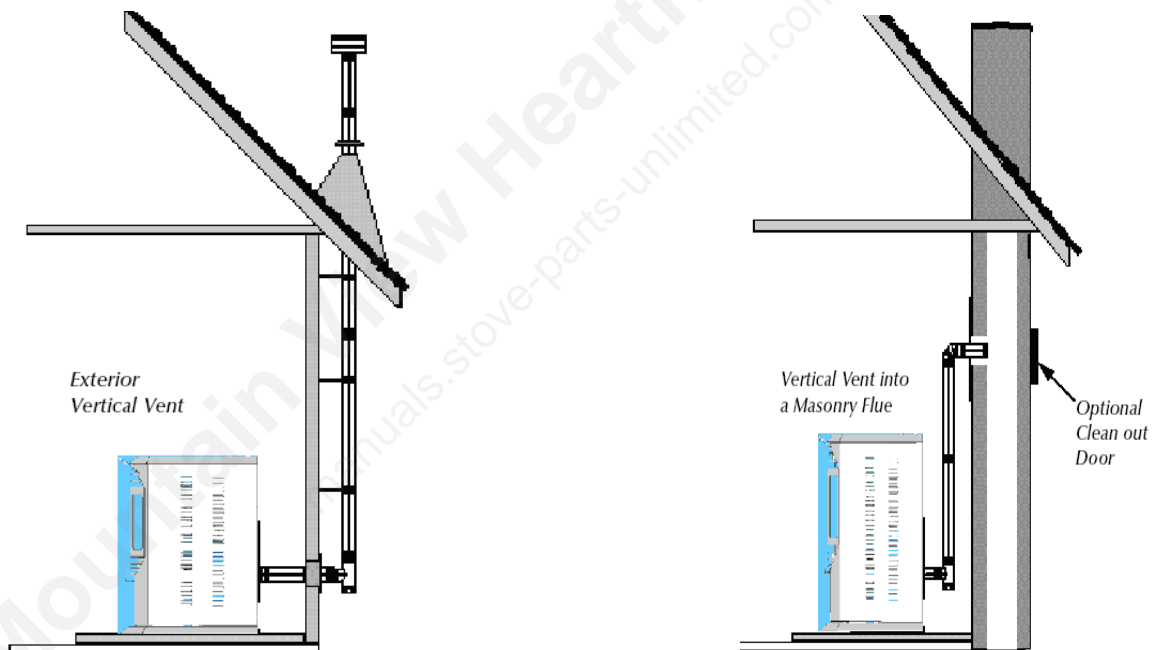

VENTING: TERMINATION REQUIREMENTS

In determining optimum vent termination, carefully evaluate external conditions especially when venting directly through a wall. Since you must deal with odors, gases, and fly ash, consider aesthetics, prevailing winds, distances from air inlets and combustibles, location of adjacent structures and any code requirements.

1. Exhaust must terminate above combustion air inlet elevation.
2. Do not terminate vent in any enclosed or semi-enclosed area, (i.e. Carports, garage, attic crawl space, etc.) or any location that can build up a concentration of fumes.
3. Vent surfaces can get hot enough to cause burns if touched by children. Non-combustible shielding or guards may be required

The type of installation must first be considered before determining the exact location of the venting termination in relationship to doors, window, cavities or air vents. See figures 4a and 4b below.

A. WITHOUT OUTSIDE AIR CONNECTED TO THE UNIT.

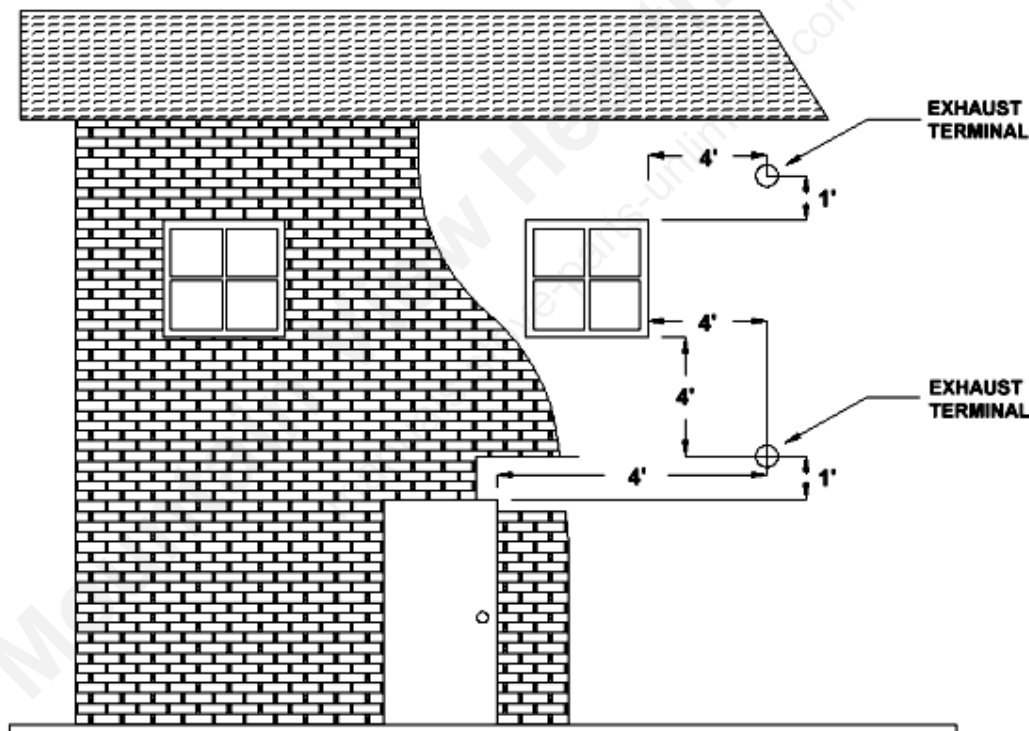

FIGURE 4a

- 4' (1.2 m) BELOW a door, window, cavity, or air vent
- Or
- 4' (1.2 m) HORIZONTALLY FROM a door, window, cavity, or air vent
- Or
- 1' (305 mm) ABOVE a door, window, cavity, or air vent

B. WITH OUTSIDE AIR CONNECTED TO THE UNIT.

In this manner the appliance is a Direct Vent Appliance (sealed Combustion System) as listed in NFPA 211-6.

3.3.3.2 Direct Vent Appliance (Sealed Combustion System Appliance) A system consisting of an appliance, combustion air and flue gas connections between the appliance and the outside atmosphere, and a vent cap supplied by the manufacturer, and constructed so that all the air for combustion is obtained from the outside atmosphere and all flue gases are discharged to the outside atmosphere.

Special Venting Arrangements are listed in NFPA 211-31

10.7.1.2 The Vent Terminal of a Direct Vent Appliance with an input of 10000 BTU/Hr or less shall be located at least 6" from any opening into a building, and such an appliance with an input of over 10000 BTU/Hr, but not over 50000 BTU/Hr shall not be located less than 9" from any opening through which vent gases could enter a building, and the vent terminal of such appliance with an input over 50000 BTU/Hr shall be located not less than 12" from the opening.

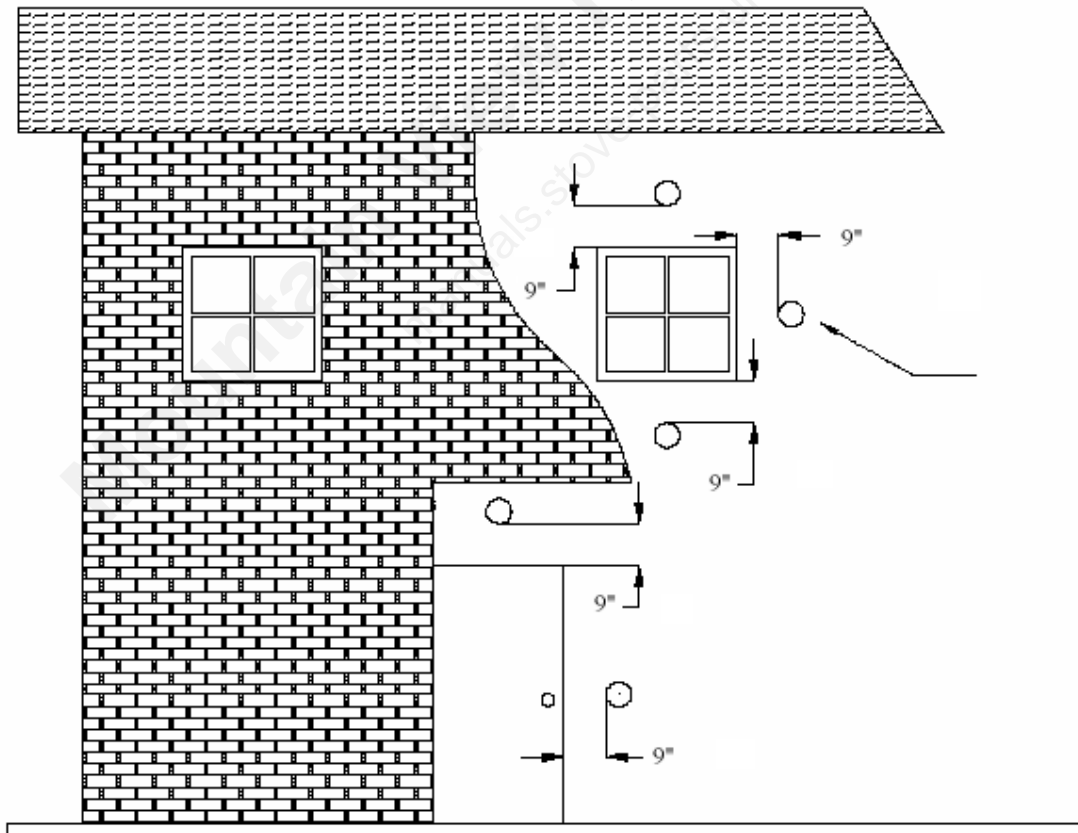
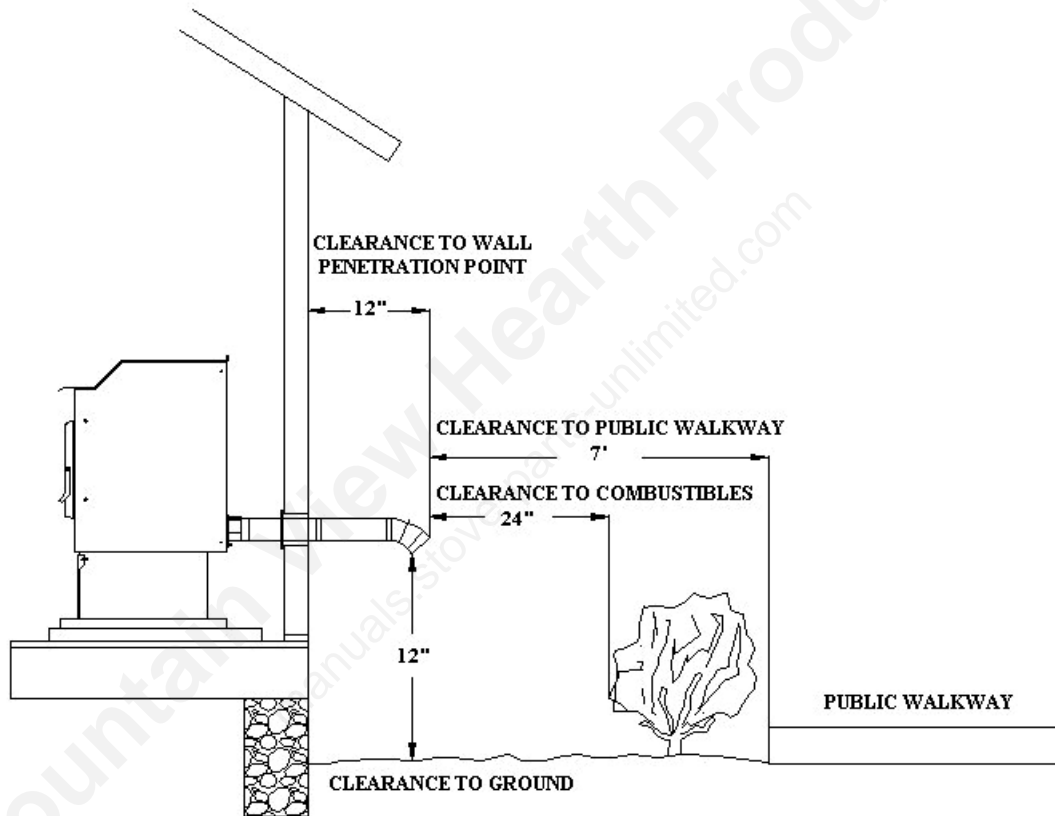

Figure 4b

THE EXHAUST TERMINATION LOCATION MUST BE AT LEAST:

- 1' (305 mm) ABOVE the ground level
- 7' (2.1 m) FROM a public walkway
- 1'(305 mm) FROM The wall penetration point
- 3' (915mm) FROM a gas meter/regulator assembly
- 2' (610 mm) FROM any adjacent combustibles such as:
Adjacent buildings, fences, protruding parts
of the structure, roof eaves or overhangs,
plants, shrubs, etc.

Note: Certain local code restrictions may apply. Check with Local Officials first before installing.



VENTING: TERMINATION CLEARANCE REQUIREMENTS SIDE VIEW
(All dimensions show MINIMUM distances)

COMBUSTION AIR

WARNING: USE THE AIR INTAKE DAMPER FOR ADJUSTING COMBUSTION INLET AIR ONLY! OTHER METHODS OF RESTRICTING OR BLOCKING COMBUSTION INLET AIR IS STRICTLY PROHIBITED!

1. It is recommended that the stove be connected to an outside source of combustion air under certain conditions (negative pressure). Any flexible metal hose or rigid metal pipe (conduit) must be connected around (NOT INSIDE) the combustion air inlet tube. Be careful not to pinch or bend the outside air pipe with too small a radius. Outside Air Pipe may be terminated flush with the outside wall but should be protected from wind and weather by a hood. Note: The outside air pipe must terminate above the maximum snow line and below the exhaust vent outlet.
2. Increase the outside air pipe diameter to 3" for runs over ten (10) feet and elevation over 4,000 feet. Note: Long runs should be avoided.
3. Terminate the outside air pipe below the exhaust vent outlet.
4. An open mesh screen should be placed over the outside air pipe opening to prevent birds or rodents from nesting in the opening. Use an elbow or shield to prevent prevailing winds from blowing directly into the outside air intake pipe. NOTE: Mesh screen should be no smaller than one-fourth inch (1/4") by one-fourth inch (1/4").
6. In the case of a **Custom made** sealed fireplace insert shroud, an outside air inlet to the fireplace cavity is necessary to ensure adequate airflow for combustion.

Electrical:

The unit must be grounded. The grounded electrical cord should be connected to a standard **115V, 60Hz(4.5 Amps), (115 volts (4.5 Amps), 60 hertz)** electrical outlet. Be careful that the electrical cord is not trapped under the appliance and that it is clear of any hot surfaces or sharp edges and also must be accessible. If this power cord should become damaged, a replacement power cord must be purchased from the manufacturer or a qualified dealer.

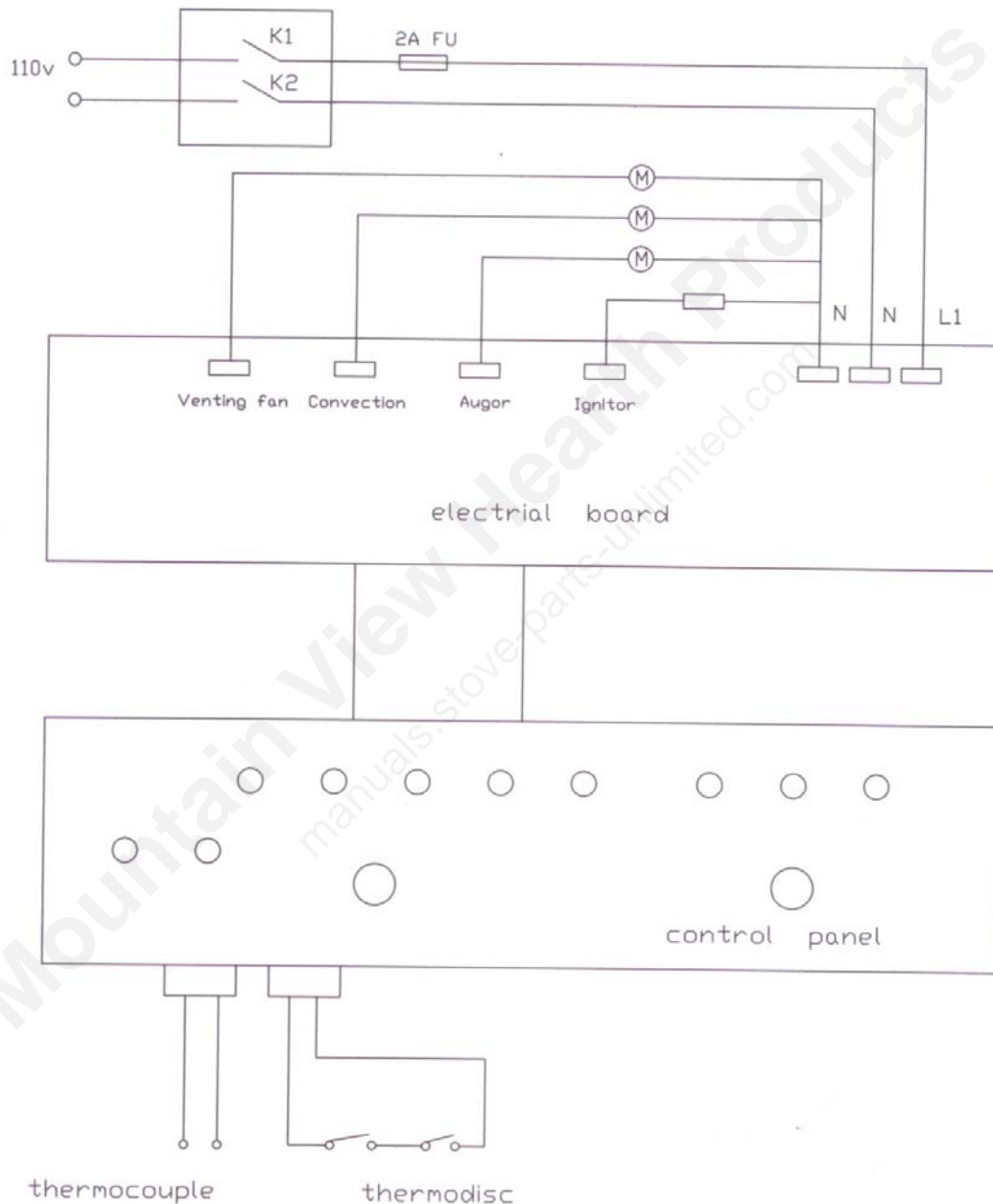

Electrical figure

MOBILE HOME INSTALLATION

Mobile home installation should be done in accordance with the Manufactured Home and Safety Standard (HUD), CFR 3280, Part 24.

In order for this unit to be installed in a mobile home the following criteria must be met:

- The unit must be secured to the floor using lag bolts in the holes provided in the pedestal base.
- Ensure that the unit is permanently electrically grounded to the chassis of your home.

IT IS MANDATORY TO TAKE THE COMBUSTION AIR FROM THE OUTSIDE WHEN INSTALLING THIS UNIT IN AIR TIGHT OR MANUFACTURED/MOBILE HOMES.

CAUTION:

THE STRUCTURAL INTEGRITY OF THE MANUFACTURED HOME FLOOR, WALL, AND CEILING/ROOF MUST BE MAINTAINED.

WARNING: DO NOT MAKE COMPROMISES DURING INSTALLATION. FOLLOW ALL CLEARANCE REQUIREMENTS AND CHIMNEY INSTRUCTIONS CAREFULLY. FAILURE TO FOLLOW THESE REQUIREMENTS MAY RESULT IN PROPERTY DAMAGE, BODILY INJURY, OR EVEN DEATH.

WARNING:

DO NOT INSTALL IN A BEDROOM.

Maintain an effective vapor barrier at location where vent exits the structure.

Check any other local building codes or other codes that may apply.

Follow Vent manufacturer's installation directions and observe all listed clearances to combustibles.

Operation Instructions

1. The first ignition

Some odors may be given off during the first few hours of burning during initial break-in.

These odors are normal and not harmful. However, ventilating the room until the odors disappear is recommended. The stove will become HOT while in operation. Keep children, clothing and furniture away from all stove surfaces. **WARNING: DIRECT CONTACT WITH THE STOVE WHILE OPERATING MAY CAUSE SKIN BURNS.**

To avoid the possibility of smoke and/or sparks entering the room always keep firebox and de ashing doors closed whenever the stove is operating.

Please connect the power and put wood pellet fuel (max. 20kg) into the hopper.

2. Start and operation



To Start up a Cold Stove

Press and release the On/Off button. The green light above the On/Off button will flash to indicate that the start up cycle has started. The light above the Auger button will turn on, intermittently, indicating the activation of the auger which is feeding the pellets into the burn pot. At this time the electric igniter is activated. The igniter takes a few minutes to heat up enough to ignite the pellets in the burn pot. This may take as little as 3 minutes or as much as 8 minutes. **If no flames appear prior to 15 minutes the stove will shut down and will need to be turned back on again.**

Once the flame has been established, the start up cycle will end, this takes between 10 - 15 minutes. At this point, if the stove is in the manual mode, it will default to the lowest heat level setting. If the stove is in either the AUTO or T-STAT mode the heat output will vary in accordance with the commands from the thermostat.

To Start up a Hot Stove

If the stove is warm at re-start, the On/Off button must be pressed down and held for 2 seconds or more until the Heat Level light is lit.

When first starting a new pellet stove, or when you completely empty the hopper of pellets, you can press and hold the AUGER button to get the pellets into the burn pot quicker. See AUGER button description on page 10.

The convection air flow will change in accordance with the heat setting. Convection air flow is at maximum when the heat setting is at maximum. Air flow will be at a minimum when the heat setting is at a minimum. If the user wishes to turn the convection fan on maximum, at any heat setting, they may do so by pressing the FAN button.

If the flame goes out, or the heat output is too high on minimum heat level setting, use the AUGER TRIM button to make adjustments. See the AUGER TRIM button description on page 11.

To Shutdown Stove

Turn off the unit by pressing the On/Off button. The stove will enter the shutdown cycle where the pellets will stop feeding to allow the fuel in the burn pot to be used up. The exhaust blower and convection fan will continue to operate until the flames are out and the unit has cooled down. Once this has been accomplished the stove will shut down completely.

In the AUTO mode the turning the thermostat all the way down can also be used to turn off the stove.

DO NOT TURN OFF THE UNIT BY DISCONNECTING THE ELECTRICAL POWER TO THE UNIT. THIS WILL CAUSE THE UNIT TO MISS THE PROPER SHUTDOWN CYCLE, CAUSING THE RELEASE OF SMOKE INTO THE HOUSE AND OVERHEATING OF THE STOVE.

Safety Features:

The stove will power off and the fire will be put out within 25min when the auger motor stops.

The stove will power off and the fire will be put out within 30min when the convection blower stops.

The auger motor stops feeding when thermodisc $T_3 \geq 93^\circ\text{C}$. When the $T_3 < 93^\circ\text{C}$, the auger motor feeds again, the stove will keep working.

IF YOU HAVE A FIRE:

- Call the fire department immediately.
- If all the stovepipe joints are tight and no other appliance is connected to the same flue, close all openings, and draft controls if you have an airtight stove. Close the stovepipe damper in a non airtight stove.
- If you have a leaky stove, you may have to wait for the fire to burn out.
- Get everyone out of the house, and put them to work watching for sparks or signs of fire on the roof or nearby. One adult should stay in the house to check the attic and upper floors for signs of fire.
- Discharge a class ABC dry chemical fire extinguisher or throw baking soda into the stove if the chimney is not sound or there is a danger of the house or surroundings catching on fire. The chemical travels up the chimney and often extinguishes the flame. Special fire extinguishers are also available for stove and chimney fires. They give off intense smoke and smother the fire.
- Throwing water in a stove will cause the metal to warp, but if it's a choice between the house or the stove, use water.
- Make sure the chimney is inspected after a fire. A chimney fire can cause deterioration of metal or cause masonry to weaken.

Maintenance

Daily Maintenance

ALL Maintenance should be done when the stove is shut off and cold.

1. Check Grate and Shaker Plate to determine if holes are plugged.
 - a. Clean as needed.
 - b. Open the firebox door slowly to prevent drawing ash or odors into the room.
 - c. Use the “scraper” provided to move the burning pellets to one side of the grate, leaving the ash in the bottom of the grate.
 - d. Rake the ash & clinkers out over the grate into the ash pan.
 - e. Rake the burning pellets across the bottom of the grate.
 - f. Close the door.

CAUTION: NEVER ADD FIRE STARTER TO A HOT STOVE.

2. Remove ash buildup under the grate bottom daily or as frequently as needed. Clean the ashes out from under the burn pot by pulling the Ash Cleanout Rod in and out several times

CAUTION: The Ash Cleanout Rod must be pushed all the way in during operation of the unit. Failure to keep this area clean could result in a safety hazard.

3. Check ash pan to determine emptying frequency needed. NOTE: Do not use a vacuum cleaner for this purpose. Hot coals may cause your vacuum filter to catch fire. Place ashes in a metal container with a tight fitting lid. The closed container of ashes should be placed on a noncombustible floor or on the ground, well away from all combustible materials, pending final disposal. If the ashes are disposed of by burial in soil or otherwise locally dispersed, they should be retained in the closed container for at least two days until all cinders have thoroughly cooled.
4. Once or twice daily pull the Heat Exchange Tube Scraper, out and back to clean heat exchange tubes. Failure to operate the tube scraper daily may result in poor combustion and loss of heat output. This should be done when the stove is cool or operating on the low temperature setting.
5. The rate of burn and the quality of fuel will determine how often the window needs cleaning. Prolonged burning at a slow burn rate will result in the need for more frequent window cleaning. Burning poor fuel also increases the need to clean the window. Cooling the stove and wiping the window daily with a cloth or paper towel will normally keep the window from accumulating difficult to clean residue. Use of a glass cleaner ONLY permitted when the stove is cold. *Tip: Dip the damp towel in the ashes to remove stubborn buildup on the glass. NEVER USE ABRASIVE CLEANER ON GLASS SURFACES.*

CAUTION: Do not slam the door. Do not operate the stove with a broken or cracked glass. Replace only with heat resistant ceramic glass supplied by the manufacturer.

6. Burn the stove at the HI fuel setting for at least 20 to 30 minutes each day. This helps keep the window, ceraboard and firebox area clean. A daily high burn also aids in maintaining the overall efficiency and performance of the stove.

Maintenance (CONTINUED)

PERIODIC MAINTENANCE

CAUTION: Periodic maintenance should only be done while the stove is shut off and cold. Empty the ash pan when it appears full. The frequency of cleaning the ash pan will depend on the quality and amount of pellets being used. Carefully check to make sure the ash pan door is tightly closed after each opening. Scrape ash into ash pan. Use a vacuum (cold stove only) to thoroughly clean these areas.

IT IS CRITICAL THAT YOU KEEP ASH CLEAN OUTS CLEAN FOR SATISFACTORY PERFORMANCE.

Failure to clean the ash traps can cause the stove to become plugged with fly ash and could result in a Safety Hazard.

Clean burn grate holes at least weekly. Remove the burn grate and use a small metal object to clean out plugged holes.

Remove the baffle and clean the ashes that accumulate on a regular basis. Frequency of cleaning depends on amount of fuel being burnt and the quality of the pellets. Fuel with low ash content is recommended.

Failure to clean the baffle can cause the stove to become plugged with fly ash and could result in a Safety Hazard.

Periodic cleaning of the exhaust system is required. Under certain conditions creosote buildup may occur rapidly. Low quality pellets and poor installations require more frequent chimney cleanings. The products of combustion will also contain small particles of fly ash. The fly ash will collect in the exhaust vent and restrict the flow of the flue gases. Judge the frequency of cleaning by checking the amount of ash that accumulates in the elbows or tee's of the exhaust system. Ask the dealer for suggested frequency of cleaning, equipment needed and procedures for cleaning. Check the exhaust system at least once every two months during the heating season. Periodically inspect the condition of the rope gasket around the door, window and ash door. Replace as needed.

Maintenance (CONTINUED)

Yearly Maintenance

Yearly maintenance is designed to assure safe operation, prolong the life of the stove and help preserve its aesthetic appeal.

1. **Spring Shutdown.** After the last burn in the spring, cool the stove. Remove all pellets from the hopper and the auger. Thoroughly clean the burn grate, burn grate box, ash pan and ash traps behind the ash pan.

NOTE: UNPLUG THE STOVE. Open the side panels of the stove. Carefully clean or vacuum any sawdust, cobwebs and household dust.

Carefully vacuum around the fan motors. If electrical wires become disconnected call your dealer for service.

2. The exhaust system should be thoroughly cleaned at least annually. Call your dealer for this service.

3. The motor/fan area behind the firebox and under the hopper should be vacuumed annually.

4. The Exhaust and Room fans should be removed and cleaned annually. Call dealer for this service. Annual oiling of the motors is not needed

SAFE OPERATION

1. **Disposal of Ashes.** Ashes should be placed in a metal container with a tight fitting lid. The closed container of ashes should be placed on a non-combustible floor or on the ground, well away from all combustible materials, pending final disposal. If the ashes are disposed of by burial in soil or otherwise locally dispersed, they should be retained in the container until all cinders have thoroughly cooled.

2. **Never use Gasoline,** gasoline type lantern fluid. Kerosene, charcoal lighter fluid or similar liquids to start or “freshen up” a fire in this heater. Keep all such liquids well away from the heater while it is in use.

3. **Creosote, Soot and Fly Ash:** Formation and Need for Removal. The products of combustion will contain small particles of Fly Ash. The fly ash will collect in the venting system and restrict the flow of flue gases. Incomplete combustion, such as occurs during start-up and shutdown, or incorrect operation of the room heater will lead to some soot or creosote formation which will collect in the venting system. The exhaust system should be inspected at least once every year to determine if cleaning is necessary. Check more frequently at first to determine a schedule for cleaning the venting system based on individual use of this Pellet-burning heater. If creosote has accumulated, it should be removed to reduce the risk of a chimney fire.

4. **Do not Overfire this unit.** Follow all instructions regarding the proper use of this heater.

CAUTION: The Electrical Components of the stove are not Owner Serviceable. Call your dealer for proper diagnosis of electrical problems and service to those components.

5. DO NOT MODIFY ANY OF THE BURN AREAS INSIDE THE STOVE. THE STOVE HAS BEEN ENGINEERED TO UTILIZE THE BURN POT AND DROP CHAMBER. DO NOT ADD GRATES OR OTHER METHODS OF SUPPORTING FUEL.

Troubleshooting

The control panel of the stove has trouble examine lights kit which are red, green and blue by 220V. Three lights are bright and flash when the stove is on normal work. When the sensor detect the abnormal work temperature (below 50°C or over 93°C), the auto-control temperature switches will shut off the fuel feed system automatically to prevent the pellet pile or overheat. When temperature is below 50°C, the safety control system will stop the stove automatically.

The general trouble, the possible reason and the solution are as following, after solving problems, start the stove again:

problems	reason	solution
1. The blower doesn't work after pressing the start bottom.	No power in stove or in the control panel.	Check the power and wires.
2. No feed after igniting. A. Three lights are bright and flash.	Feed unit is blocked. Auger motor doesn't work.	Check the auger is blocked or not. Check auger motor is blocked or not. And the wires break or not. Check the fasten screw between auger and motor loose or not.
B. Three lights are bright but no flash.	No fuel in the hopper. The clock unit breaks.	Fill the fuel into the hopper. Change the clock unit.
C. The red light is bright and flash but other lights aren't bright.	The high temperature switch disconnects. The high temperature switch breaks.	Tight the high temperature switches connection. Change the high temperature switch
D. Three lights aren't bright.	No 115V power. Pellet feeder is power off. The wires of start and clock unit loose or break.	Check the 115V power. Turn on the auger motor switch. Check the wires of start and clock unit or change the unit.
3. After ignition the power is off 15min late.	Pellet feeder unit is off or pellet is too little. 50°C temperature switch breaks or the connection wires of switch loose.	Check the pellet feeder unit and restart. Check the connection wires or change the 50°C temperature switch.
4. orange and lazy fire, piled pellet, carbon on the glass	Lack of air intake for burning.	Clean the block in gatebar. Adjust the knob of convection blower and increase the air intake. Check the door and window glass gasket sealed or not. Check the air intake pipe and venting pipe blocked or not, and clean it. Change to the big diameter pipes if pipes are too long to affect combustion.

5. The fire put out and power is off automatically.	The hopper is empty. No fuel feed. The fuel feed is too little. High temperature switch (93°C) is wrong.	Put fuel into the hopper. refer to (2) Increase the fuel feed. Cool the stove at least 1 hour then operate again or change the high temperature switch (93°C).
6. The blower still works after the stove is cool and fuel feed stops.	The low temperature switch (50°C) is broken.	Change this switch.
7. no enough heat wind	Unqualified fuel Blower speed is too high. Heat exchange tubes are dirty.	Use the standard specially pellet. Turn down the blower. Clean the heat exchange tubes.
8. Ash and smoke fly out.	Leak between the connection of convection motor and venting pipe. The clean method is wrong.	Use silicon rubber to seal. Clean the dust in the stove with brush to ash drawer.

REPLACEMENT PARTS

Contact an authorized Hudson River Stove pellet stove dealer to obtain any of these parts. Never use substitute materials. Use of non-approved parts can result in poor performance and possible safety hazards as well as voiding the Warranty.

<u>506S</u>	<u>CONTROL BOARD</u>
<u>510S</u>	<u>CONVECTION BLOWER</u>
<u>511S</u>	<u>COMBUSTION BLOWER</u>
<u>508S</u>	<u>HIGH LIMIT SWITCH</u>
<u>509S</u>	<u>LOW LIMIT SWITCH</u>
<u>507S</u>	<u>AUGER MOTOR</u>
<u>514S</u>	<u>IGNITOR</u>
<u>512S</u>	<u>VACUUM SWITCH</u>
<u>529S</u>	<u>POWER CORD</u>
<u>528S</u>	<u>AUGER SHAFT</u>

Warranty

Limited Lifetime Warranty:

Under this warranty, Hudson River Stove Works covers the body of the stove including all exterior metals. This warranty covers: Firebox, Heat Exchanger, Pedestals, Legs, and Door Assembly.

Limited Two Year Warranty:

Under this warranty, Hudson River Stove Works covers electrical components against defects in materials and workmanship for part repair and replacement for the first two years and labor for the first year only to the original purchaser. (Glass and all gaskets are not included under any part of this warranty).

There is no written or implied performance warranty on the stove, as the manufacturer has no control over the installation, daily operations, maintenance or the type of fuel burner. This warranty will not apply if the stove has not been installed, operated and maintained in strict accordance with the manufacturer's instructions.

This warranty does not cover damage or breakage due to misuse, improper handling or modifications.

All Claims under this warranty must be made through the dealer in which the stove was originally purchased from. If an inspection by the dealer indicated that a warranty claim is justified, and that all conditions of this warranty have been met, the manufacturer's total responsibilities and liabilities shall be to repair or replace the defective part (s). All costs of removal, shipment to and from the dealer of manufacturer, any losses during shipment and reinstallation and any other losses due to the stove being removed shall be covered by the owner of the stove.

The Retailer does not have the authority to alter this warranty.

For **further information**, contact:

Hudson River Stove Works

1871Route 9H Hudson NY 12534

www.hudsonriverstoves.com