

“Save These Instructions”



Cheap Charlie

THE THRIFTY HEATER

Owner's Manual

ACUIRON II^{or}III CONTROL

CC Edison Sr.
HCS



Model
CC 2

CC Franklin300
HCF300



Model
CC 2

CC Franklin120
HCF120



Model
CC 1

CC Edison Jr.
HCJ



Model
CC 1

Toll Free Technical Support

1 - 866 - 456 -9269

Manufactured by:

CCI Canadian Comfort Industries

A Vanderwell Company

DGI Dansons Group Inc.
Responsible Resource Development

To register your purchase

www.dansons.com/support

My local Cheap Charlie dealer is:

www.cheapcharliestoves.com



**READ THIS ENTIRE MANUAL BEFORE YOU INSTALL AND USE YOUR HEATER.
FAILURE TO FOLLOW INSTRUCTIONS MAY RESULT IN PROPERTY DAMAGE,
BODILY INJURY OR EVEN DEATH!**

Installation shall conform to CAN/CSA B365 Installation Code for Solid-Fuel-Burning Appliances and Equipment in Canada and NFPA 211 Chimney, Fireplaces, Vents and Solid Fuel Burning Appliances in the USA.

Contact local building or fire officials about restrictions and installation inspection requirements in your area.

Dear **Cheap Charlie** Owner:

CONGRATULATIONS on the purchase of your **Cheap Charlie** wood pellet shop and home heater! You have selected the finest in residential wood pellet heating technology.

Let us pass on a few "**tips**" concerning installing your heater and heating with wood pellets.

1. Whether you install your stove yourself or hire a professional installer, **a quality installation is a must** for the safety of your family and for efficient, satisfactory operation of your stove.
2. **Initial setup of the stove is the most important step** to ensure the efficient and satisfactory operation of your home and shop heater for many years to come.
3. **Know the quality and characteristics of the pellets you burn.** Pellets can vary greatly from company to company, from load to load and occasionally from bag to bag.
4. **Be extra diligent in your cleaning program.**
5. Remember that **most operational dilemmas** with pellet stoves are usually traced back to **Improper installation, poor quality pellets and/or a lack of timely cleaning.**

With just a minimum of daily care your **Cheap Charlie** heater will provide years of clean, efficient, comfortable and environmentally sound heating.

Thank you for selecting a **Cheap Charlie** wood pellet shop and home heater.

Sincerely,

**Canadian Comfort Industries &
Dansons Group Inc.**

UPDATES

Up to date additions, product registration and warranty extension registration can be found on our website
www.dansons.com/support.

COPYRIGHT NOTICE

Copyright 2004, **Canadian Comfort Industries**. All rights reserved.

No part of this manual may be copied, transmitted, transcribed, stored in a retrieval system, in any form or by any means without the expressed written permission of,
Canadian Comfort Industries; 26319 Twp Rd 531, Acheson, AB, Canada T7X 5A3

TABLE OF CONTENTS

INTRODUCTION	2
TABLE OF CONTENTS	3
SAFETY PRECAUTIONS	4,5
SPECIFICATIONS	6
AUTOMATIC SAFETY FEATURES	7
INSTALLATION OPTIONS	8
INSTALLATION CHECK LIST	9
EXHAUST SYSTEMS	10
GENERAL	10
EXHAUST SYSTEM SIZING	10
EXHAUST SYSTEM TERMINATION	11
OUTSIDE AIR	12
FREESTANDING INSTALLATION	13
STOVE PLACEMENT	13
FLOOR PROTECTION	13
CLEARANCES TO COMBUSTIBLES	13
STRAIGHT INSTALLATION	13
CORNER	14
ALCOVE	14
THROUGH THE WALL DIRECT INSTALLATION	15
VERTICAL INSTALLATIONS	16
MOBILE HOME INSTALLATION	17
OPERATING YOUR STOVE	18
HOW YOUR HOME OR SHOP HEATER WORKS	18
LIGHTING A FIRE	19
THE CONTROLS	20-21
SHUTTING THE STOVE OFF	21
PERFORMANCE ENHANCEMENT TIPS	22
INITIAL BURN SETUP	23
PELLETS	
PELLET QUALITY	24
PELLET CONSUMPTION	24
FACTORS EFFECTING PELLET FEED RATES	24
FINE TUNING THE PELLET FEED RATES	24
ASH and CLINKERS	24,25
FINES	25
PFI PELLET STANDARDS	25
REQUIRED ROUTINE CLEANING	26
PERIODIC MAINTENANCE	27-28
TROUBLE SHOOTING	29
LIMITED WARRANTY	30
APPENDIX "A" - INSERTING, REMOVING, AND ADJUSTING THE BURN GRATE	31,32
APPENDIX "B" – SETUP TIPS	33
APPENDIX "C" – OPTIONS	34
APPENDIX "D" – ACCESSORIES	35
APPENDIX "E" – "ACU-TRON" WALL THERMOSTAT	36,37
APPENDIX "F" – HOPPER CLEAN-OUT DROP CHUTE	38
SERVICE & MAINTENANCE LOG	39

SAFETY PRECAUTIONS

- Do not operate the heater if you smell smoke coming from the heater. Push the “OFF” Touch pad, monitor your heater, and call your dealer.
- Never use gasoline, gasoline-type lantern fuel, kerosene, charcoal lighter fluid, or similar liquids to start or ‘freshen up’ a fire in this heater. Keep all such liquids well away from the heater while it is in use.
- Don’t unplug the heater if you suspect a malfunction. Push the “OFF” Touch pad and inspect the heater.
- Do not operate the heater if the flame becomes dark & sooty or if the firepot overfills with pellets. Push the “OFF” Touch pad and periodically inspect the heater (see “Operating Your Stove”).
- Never try to repair or replace any part of the heater unless instructions for consumer are given in this manual. All other work should be done by a trained technician.
- The viewing door and ash pan must be closed and latched during operation.
- Never block free airflow through the open vents of the unit.
- Contact your local building officials to obtain a permit and information on any installation restrictions or inspection requirements in your area. Notify your insurance company of this heater as well.
- The pellet appliance exhaust system works with negative combustion chamber pressure and a slightly positive chimney pressure, therefore the exhaust system must be completely airtight and properly installed. All pellet vent joints must be sealed with HI-TEMP RTV silicone sealant and at least 3 sheet metal screws, to each other as well as to the heater.
- This unit must be properly installed to prevent the possibility of a house fire. The instructions must be strictly adhered to. Do not use makeshift methods, which may compromise the installation.
- Your heater requires periodic maintenance and cleaning (see “Operating Your Stove”). Failure to maintain your heater may lead to smoke spillage in your home.
- Allow the heater to cool before carrying out any maintenance or cleaning. Ashes must be disposed in a metal container with a tight fitting lid. The closed container of ashes should be placed on a non-combustible surface or on the ground, well away from all combustible materials, pending final disposal.
- This heater is designed and approved for pelletized wood fuel only. Any other type of fuel burned in this heater will void the warranty and safety listing.
- The heater will not operate during a power outage. If a power outage does occur, check the heater for smoke spillage and open a window if any smoke spills into the room.
- Keep foreign objects out of the hopper.

SAFETY PRECAUTIONS . . . Continued

- Disconnect the power cord before performing any maintenance. NOTE: Touching the OFF touch pad does not disconnect all power to the heater.
- **Do not throw this manual away.** This manual has important operating and maintenance instructions that you will need at a later time. Always follow the instructions in this manual.
- Do not place clothing or other flammable items on or near the heater. Because this heater can be controlled by a thermostat there is a possibility of the heater turning on and igniting any items placed on or near it.
- This heater must be connected to a standard 110 - 120V., 60 Hz grounded electrical outlet. Do not use an adapter plug or sever the grounding plug. Do not route the electrical cord underneath, in front of, or over the heater.
- It is recommended to connect the heater to a standard 110 – 120V ground surge protected unit or surge protected electrical outlet..
- When installed in a mobile home, the heater must be bolted to the floor, have outside air, and **MUST NOT BE INSTALLED IN THE BEDROOM** (Per H.U.D. requirements). Check with local building officials.
- Educate all children on the dangers of a high-temperature heater.
- Young children should be supervised when they are in the same room as the heater.
- Caution: **NEVER PUT FINGERS NEAR AUGER.** Pellet fuel is fed to the burn pot by a screw auger that is driven by a high torque motor. The auger can start and stop automatically anytime while the heater is operating.
- Do not connect this appliance directly to air ducts or any air distribution system. This will void any warranty.
- Do not burn with insufficient combustion air. A periodic check is recommended to ensure proper combustion air is admitted to the combustion chamber. Setting the proper combustion air is achieved by adjusting the slide damper located on the right hand side of the appliance.
- It is advisable to clean the exhaust vent bi-annually or every two tons of pellets.
- Soot or creosote may accumulate when the stove is operated under incorrect conditions such as an extremely rich burn (black tipped, lazy orange flames).

Note: Canadian Comfort Industries grants no warranty, implied or stated, for the installation or maintenance of your heater, and assumes no responsibility of any consequential damage(s).

SPECIFICATIONS

HEATING SPECIFICATIONS

- Approx. Heating capacity (Sq Feet) ¹ = 800 – 2,000 sq ft
- Approx. Fuel burn rate per hour ¹¹ = 1.75 – 5.5 lbs per hour
- Hopper Capacity CC Edison Jr. / CC Franklin120 = 120+ pounds
- Hopper Capacity CC Edison Sr./ CC Franklin300 = 300+ pounds

¹ Heating capacity will vary depending on floor plan layout of your home, degree of insulation, and the outside temperature. Fuel size, quality, density and moisture level will also have an effect.
¹¹ Pellet size may affect the actual rate of fuel feed and burn times. Fuel feed rates may vary by as much as 20%. Use PFI listed fuel for best results.

DIMENSIONS

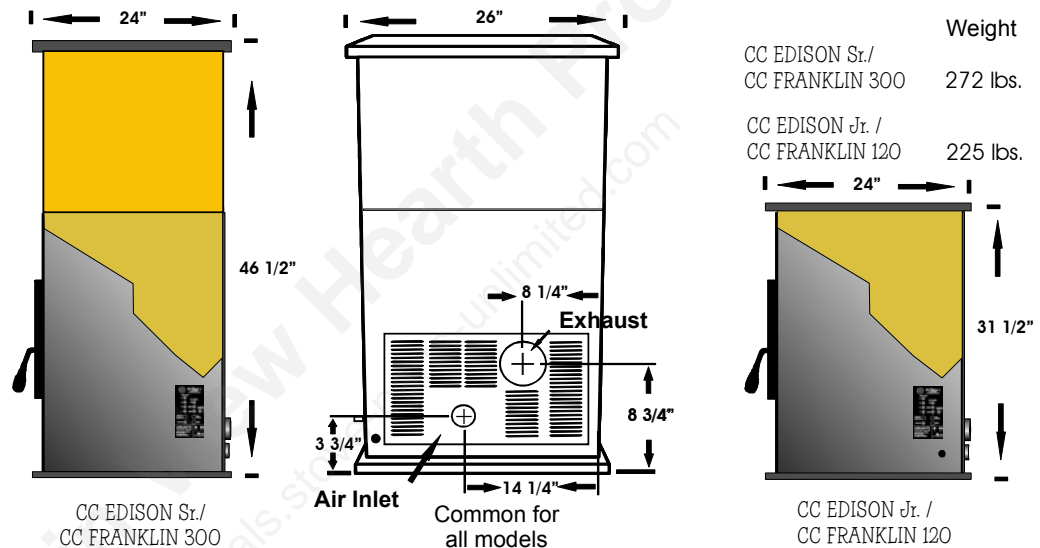

	Weight
CC EDISON Sr./ CC FRANKLIN 300	272 lbs.
CC EDISON Jr. / CC FRANKLIN 120	225 lbs.

ELECTRICAL SPECIFICATIONS

- Electrical Rating = 115 Volts 60 HZ 2.0 Amps
- Watts (operational) = 175 (approximately)
- Watts (optional igniter) = 475 (approximately)

A voltage surge protector or ground fault outlet is required for this unit. The warranty on the circuit board will be voided if surge protection is not installed before operating this unit.

FUEL CONSIDERATIONS

Your Cheap Charlie shop and home heater, is designed to burn pellets that comply with Association of Pellet Fuel Industries standards. (Minimum of 40lbs density per cubic ft, ¼ to 5/16' diameter length no greater than 1.5", not less than 8,200 BTU's/lb, moisture under 8% by weight, ash under 1% by weight, and salt under 300 parts per million) Pellets that are soft, contain excessive amounts of loose sawdust, have been or are wet, produce clinkers and/or heavy ash will result in reduced performance and may actually cause the fire to go out. (see pelletheat.org for further information)

EPA COMPLIANCE

This heater is exempt from EPA Phase II requirements, but has been tested for emissions using EPA test methods by Warnock Hersey , US. Pellet appliances that are designed with the combustion air supply exceeding 35:1 (by ratio) are exempt from EPA regulations.

PRODUCT IS SUBJECT TO CHANGE WITHOUT NOTICE.

AUTOMATIC SAFETY FEATURES

L250 HIGH LIMIT SWITCH

Your pellet appliance has a high temperature limit switch installed. If the temperature at the back of the firebox reaches approximately 250deg F., the switch will shut off the electricity going to the Vacuum Switch and to the Auger Motor. The auger will automatically stop, and the appliance will shut down when the exhaust temperature cools (120deg F). If this happens call your dealer or Dansons Customer Service (1-866-456-9269).

IT IS IMPORTANT TO FIND THE REASON WHY THE UNIT OVERHEATED.

L120 LOW LIMIT SWITCH

This limit switch is mounted on the exhaust blower housing and has 2 main functions.

1. Should the fire happen to go out, for any reason, this limit switch will shut the stove off when the exhaust temperature drops below 120deg F.
2. Upon starting the appliance, the AcuTron control board has a 15 minute "Lighting Mode", if the stove exhaust does not reach 120deg F in that 15 minutes the stove will shut off. As soon as the stove exhaust does reach 120deg F, the limit switch opens and the AcuTron enters a 5 minute "Safety Delay" mode.

F140 FAN LIMIT SWITCH

Your pellet appliance has a convection fan control limit switch. The room air fan's (F140) temperature limit snap switch automatically sets the fan on high when your stove is producing heat faster than the fan is carrying it into the room. This may occur when the heat control lever is set at [3 or 4] and the **FAN SPEED** is set to a very low or off setting. After the fan runs at this automatic high setting a few minutes, it may cycle back to its lower setting and may continue to cycle between [HIGH] and your selected setting.

The circulation (room air) fan cycling from high to low is a normal condition as well as a safety feature of your appliance. To compensate for the fan cycling, adjust the FAN SPEED to a higher setting.

VACUUM SWITCH

This safety device (mounted on the back panel pillar) detects vacuum in the exhaust system, firebox, and air intake. If the exhaust blower fails, the vent pipe becomes plugged, the viewing door is open, or if you are out of pellets, this switch will sense that there is no airflow and will stop the auger from continuing to feed pellets.

If the power does go out, the pellet appliance will stop running. When the power comes back on, the stove will not restart if the switch is in the manual mode. If the exhaust temperature is above 120deg F or the switch is in the manual position, the stove will start to feed pellets again and may re-light itself.

NOTE: If power outages are a concern you may wish to purchase a battery back-up system. It must state "For Igniter Equipped Appliance" and be a minimum of 750 watts.

For further information contact your local Specialty Retailer, Certified HVAC Service Depot, or Dansons Group Inc. Customer Service Department at 1-866-456-9269.

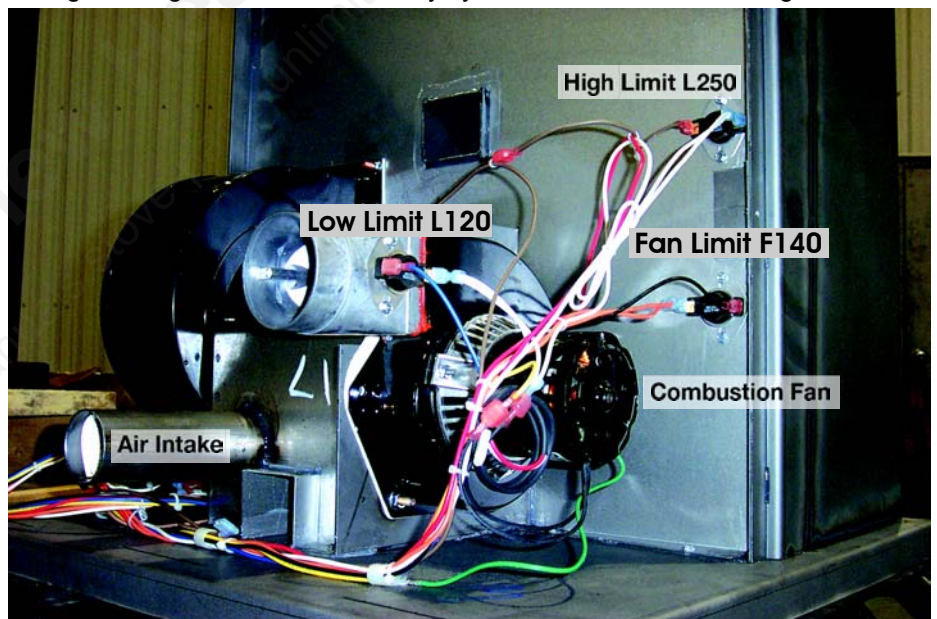

INSTALLATION OPTIONS

**READ THIS ENTIRE MANUAL BEFORE YOU INSTALL AND USE YOUR
Cheap Charlie HOME & SHOP HEATER.**

**FAILURE TO FOLLOW INSTRUCTIONS MAY
RESULT IN PROPERTY DAMAGE, BODILY INJURY OR EVEN DEATH!**

(See specific installation details for clearances and other installation requirements)

The four Cheap Charlie products are the: “HCJ” CC Edison Jr. (figure 1), the “HCS” CC Edison Sr. (figure 2); the “HCF” CC Franklin120 (figure 3) and “HCF” CC Franklin300 (figure 3a). The “HCJ” and “HCS” product come with a black door with small viewing area. The “HCF” product comes with either black painted, or brass trimmed doors, with large viewing area.

All makes& models may be installed to code in both **conventional** and **mobile homes**.

INSTALLATION OPTIONS INCLUDE:

1. A **FREESTANDING STOVE**: Set on a non-combustible floor pad.
2. A **HEARTH STOVE**: When installed on a non-combustible hearth of a masonry or factory built wood or coal burning fireplace.
3. An **ALCOVE**: When placed on a non-combustible floor pad in compliance with clearance requirements for an installation in an **alcove** (a recessed space or nook in a wall).



INSTALLATION CHECK LIST

Unless you are knowledgeable and experienced in stove installation, we recommend your Cheap Charlie heater receive a Pre-delivery Check and be installed by an Authorized Cheap Charlie Dealer.

COMPLETE THIS CHECK LIST PRIOR TO LIGHTING YOUR FIRST FIRE:

- _____ Carefully read this "Owner's manual". **SAVE THIS MANUAL.**
- _____ Obtain final inspection and approval by local building officials.
- _____ Carefully clean all marks off the brass parts before the first fire is lit. Use a soft cloth and a "Windex" type cleaner. **Caution:** Never use an abrasive cleaner on any part of your stove.
- _____ Polish the hopper to remove the oil type coating used in manufacturing.
- _____ Have your Authorized Cheap Charlie Dealer demonstrate all the operational, cleaning and maintenance steps necessary for your stove.
- _____ Sign and keep a copy of the Pre-delivery Check List supplied by your Authorized Pelpro Dealer, "Dansons Certified Installer", found inside our appliance or available online. Register online at www.dansons.com/support for Extended Warranty.
- _____ Register your purchase online at www.dansons.com/support.
- _____ Fill the hopper with quality pellets to prime the unit; Using the CCI "Acu-Tron", (figure 5), PUSH the FEED RATE Touch Pad and this will start the auger and the combustion fan.

NOTE: Do not attempt to light a fire at this time. Leave the **START / FEED RATE [ON]** for 2 to 5 minutes until pellets start dropping into the burn grate. Then touch the **OFF** pad to turn off system. The auger is now primed to deliver fuel to the burn grate (figure 6). Then light the stove according to the directions outlined in "LIGHTING YOUR STOVE",

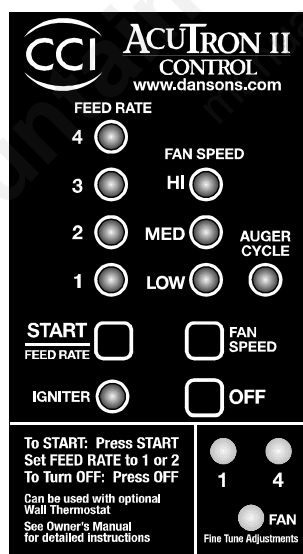

CCIAU –“AcuTron Board”
Figure 5

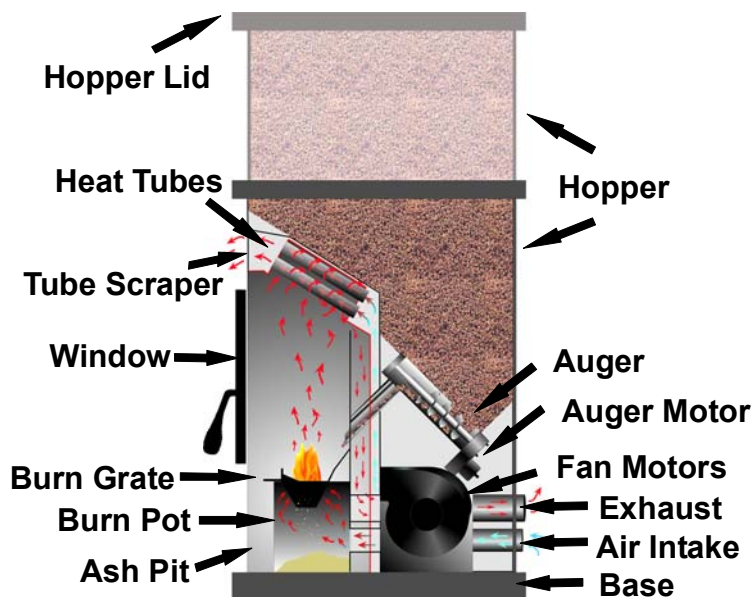

Cutaway View
Figure 6

EXHAUST SYSTEMS (GENERAL)

PELLET VENT MUST MAINTAIN A MINIMUM 3" CLEARANCE TO ANY COMBUSTIBLE (INSTALL VENT AT CLEARANCES SPECIFIED BY THE VENT MANUFACTURER).

DO NOT CONNECT THE PELLET VENT TO A VENT SERVING ANY OTHER APPLIANCE OR STOVE.

DO NOT INSTALL A FLUE DAMPER IN THE EXHAUST VENTING SYSTEM OF THIS UNIT.

PELLET VENT TYPE:

Must be an approved 3" or 4" Diameter Type "PL" vent, vented to the outside (fig. 7) or connect the vent to a factory built type "A" chimney using an adaptor; and/or "All Fuel" Stainless Steel chimney liner for masonry fireplace installations (fig. 8) . Use 4" dia. vent if vent or liner height is over 15' or if installation is over 4,000' above sea level.

VENTING DISTANCE:

Maximum venting height is 33'.
Maximum horizontal offset is 10'.
Use no more than 180° of elbows (two 90° elbows, or two 45° elbows & one 90° elbow, etc), plus termination.

Vent must have a support bracket every 5' when on the exterior wall.

If appliance is installed above 4,000' elevation, always use 4" diameter venting.

Vent height and run **must not** exceed the distance shown in the un-shaded region of chart.

To achieve optimum performance, keep vent runs as short as possible. Especially on horizontal installations.

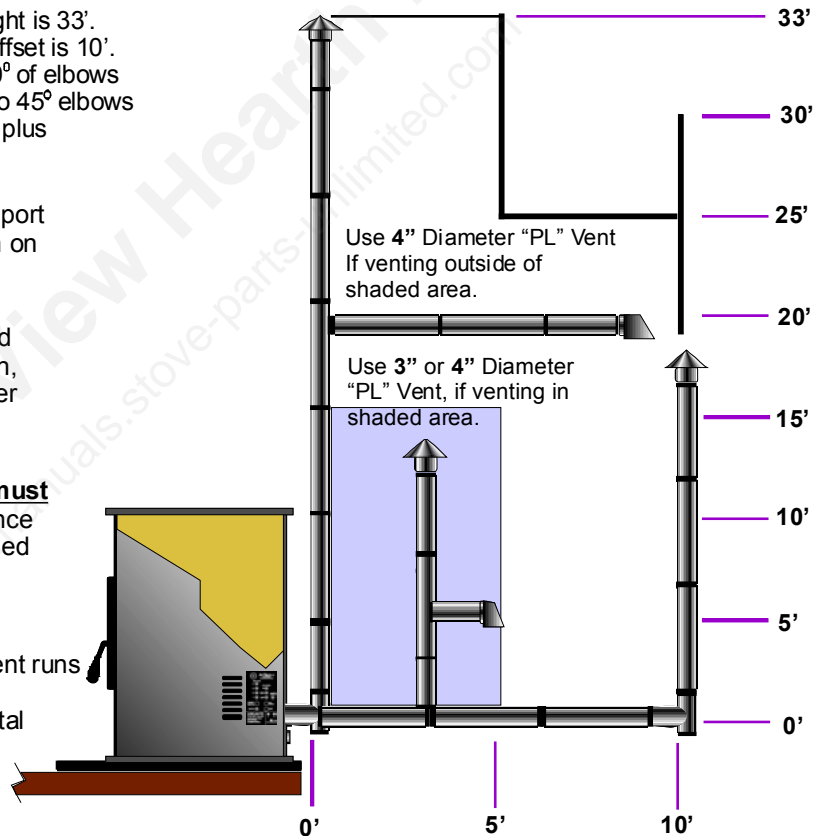

VENT INSTALLATION:

- Termination must exhaust above the air inlet elevation, and parallel or above the exhaust output of the pellet appliance. It is recommended that at least 3' of vertical pipe be installed to create some natural draft. This is to help prevent the possibility of smoke or odor during the appliance shut down.
- Horizontal sections must have a 1/4" rise every 12" of travel after 3' long.
- Pellet Vent connections must be sealed with HI-Temp RTV Silicone and screwed together with at least 3 x 3/8" long stainless steel screws. Seal each vent section by injecting a liberal amount of HI-TEMP RTV silicone sealant into the gap.

EXHAUST SYSTEMS . . . Continued

PELLET VENT TERMINATION: (Figures 7 & 8)

- ☪ Termination must be a minimum of 6" above the chimney (B) (note: the chimney must meet local codes for height above the roof or other obstructions)
- ☪ Must have an approved cap (G) (to prevent water from entering) or a 45° elbow downturn (F)
- ☪ If the termination is located on a windy side of house, an approved house shield is recommended to prevent soot from accumulating on the side of the house.
- ☪ Must not be located where snow or other materials will plug it.
- ☪ Must have a "Metal Seal Plate" or "Wall Thimble" at point (A)

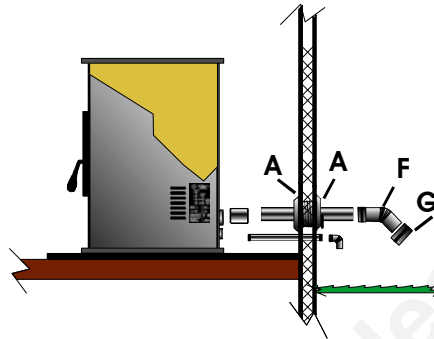

Figure 7

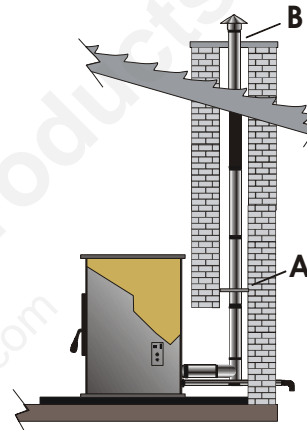

Figure 8

VENT TERMINATION CLEARANCES:

- Horizontal terminations must protrude 12" from the wall, vertical terminations 24"

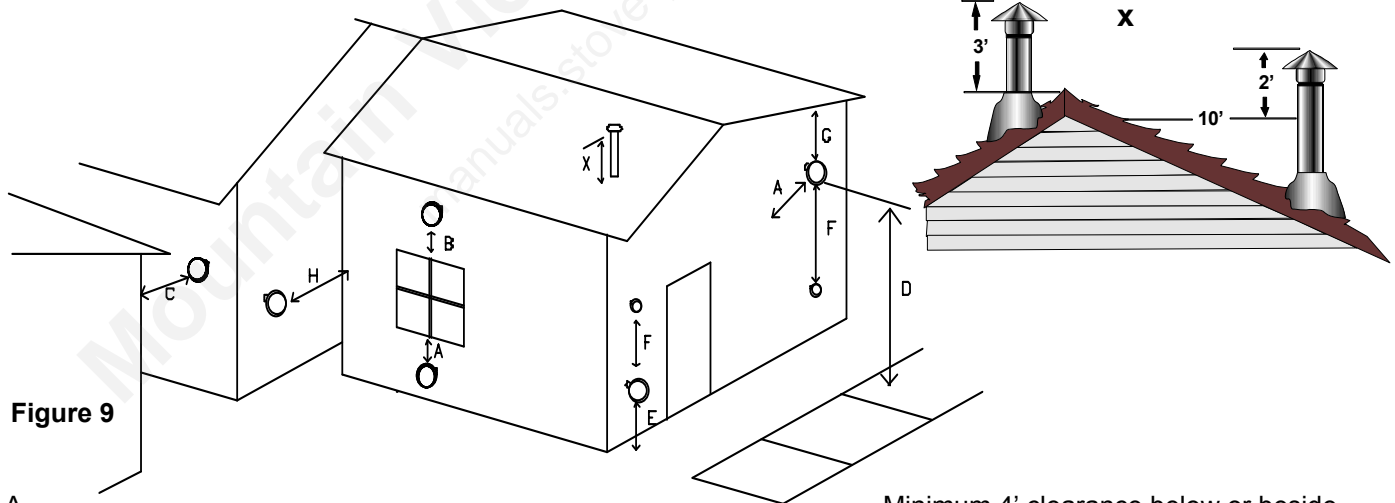







Figure 9

Minimum 4' clearance below or beside

- A any door or window which opens.
- B Minimum 1' clearance above any door or window that opens.
- C Minimum 3' clearance from any adjacent building.
- D Minimum 7' clearance above any grade when adjacent to public walkways.
NOTE: Vent may not terminate in covered walkway or breezeway.
- E Minimum 2' clearance above any grass, plants, or other combustible material.
- F Minimum 3' clearance from any forced air intake of any other appliance.
- G Minimum 2' clearance below eaves or overhang.
- H Minimum 1' clearance horizontally from combustible wall.
- X Must be a minimum of 36" above the roof and 24" above the highest point of the roof within 10'.

OUTSIDE AIR

-  Outside air is **REQUIRED ON ALL MOBILE HOME INSTALLATIONS**.
-  Outside air is strongly recommended for all other installations. Failure to install intake air may result in improper combustion as well as the unit smoking during power failures.
-  Metal pipe, **ONLY**, either solid or flexible, must be used in all outside air installations.(B)
NOTE: Non-metallic material MUST NOT BE USED for outside air installations.
-  A wind shield, (C), over the termination of the outside air pipe or a 90 degree elbow or bend directed away from the prevailing winds **MUST** be used when an outside air pipe is installed through the side of a building. Keep the outside air pipe termination at least 1 foot away from the exhaust system termination.
-  When outside air is taken from an existing chimney the exhaust system must not terminate in the same chimney.
-  The outside air pipe on your stove is 2" OD. The outside air connecting pipe must be at least 2" ID
The outside air connecting pipe must be as short and free of elbows as possible, and **must fit over**, (A), not inside, the outside air pipe on your stove.

Through The Wall Kits Include:

3 FOOT PACKAGE – PART# ACFAKT03

- 1 – 2" Galvanized Hood c/w screen
- 1 – 2" Aluminum Flex Duct – compressed 15" length, extends to 30" – 36"
- 2 – 2" Worm Gear Clamps

10 FOOT PACKAGE – PART# ACFAKT10

- 1 – 2" Galvanized Hood c/w screen
- 1 – 2" Aluminum Flex Duct – compressed 4' length, extends to 120"
- 2 – 2" Worm Gear Clamps



NOTE: Available from your local Authorized Dealer or Dansons Group Inc. 1-877-303-3134

Figure 11

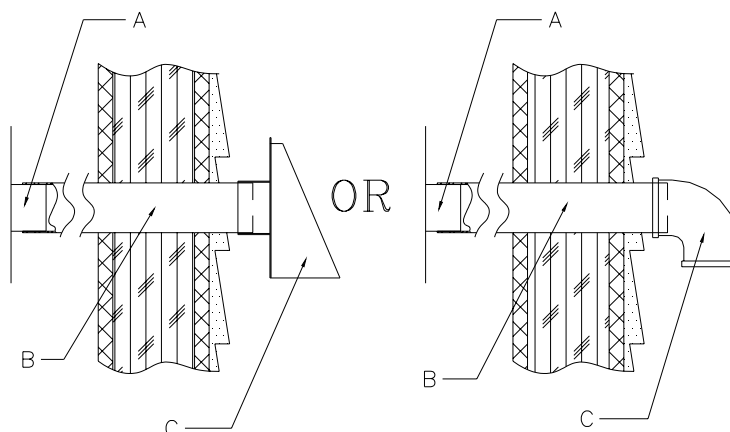

FREESTANDING INSTALLATION

HEATER PLACEMENT:



Stove must be placed so that no combustibles are within, or can swing within (i.e. drapes doors), 36" of the heater.



If the stove is placed in a location where the ceiling height is less than 7', it must follow the requirements in the section "Alcove Installation".

FLOOR PROTECTION REQUIREMENTS:



Stove and floor protection must be installed on a level secure floor



The stove must be installed on a non-combustible floor protector (i.e. sheet steel with cement, tile slate) extending the full width and depth of the stove and extending 6" in front of the stove. Floor protector needs to be a minimum of 24.5" deep X 30.5" wide and be a minimum of .018" thick (26 gauge).



Must extend under and 2" to each side of chimney tee (if used).

MINIMUM CLEARANCES TO COMBUSTIBLES

(Figures 12-17)

1" From Back Of Heater to Combustibles

10" From Front Side of Heater to Combustibles

1" From Back Corner of Heater to Combustibles

16" From Top Of Heater to Combustibles

3" From PL Vent to Combustibles

6" Non Combustible Surface In Front Of Heater
36" to drapes, doors, anything that can swing

CLEARANCES – "STRAIGHT INSTALLATION": THROUGH THE WALL

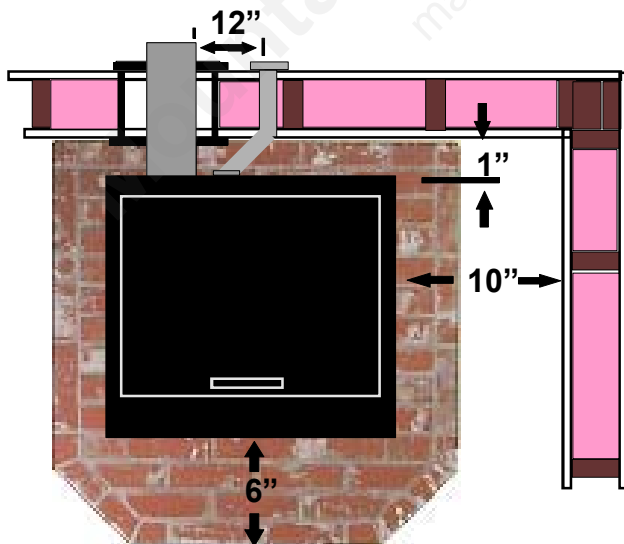

Figure 12

INTERIOR VERTICAL

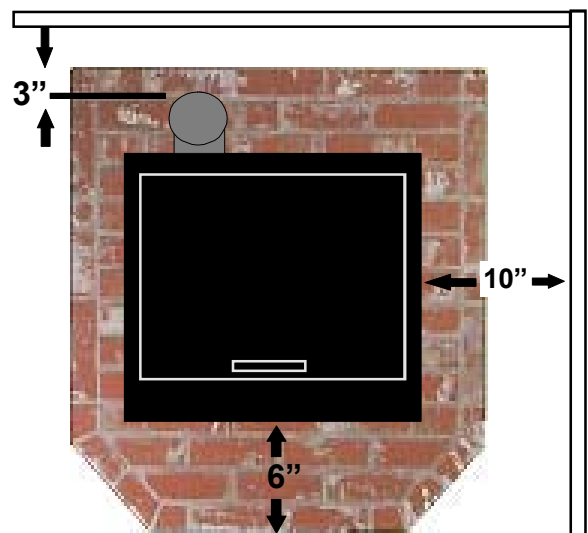

Figure 13

FREESTANDING INSTALLATION . . . continued
CLEARANCES – “CORNER INSTALLATION”:

45° CORNER

THROUGH THE WALL

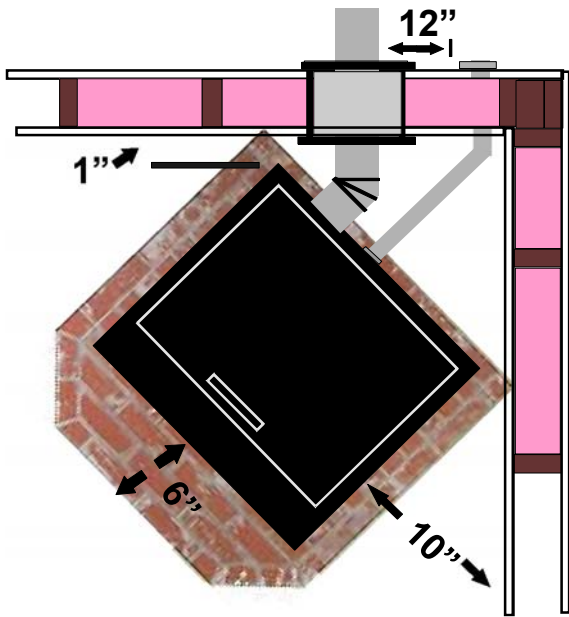

Figure 14

**45° CORNER
 INTERIOR
 VERTICAL**

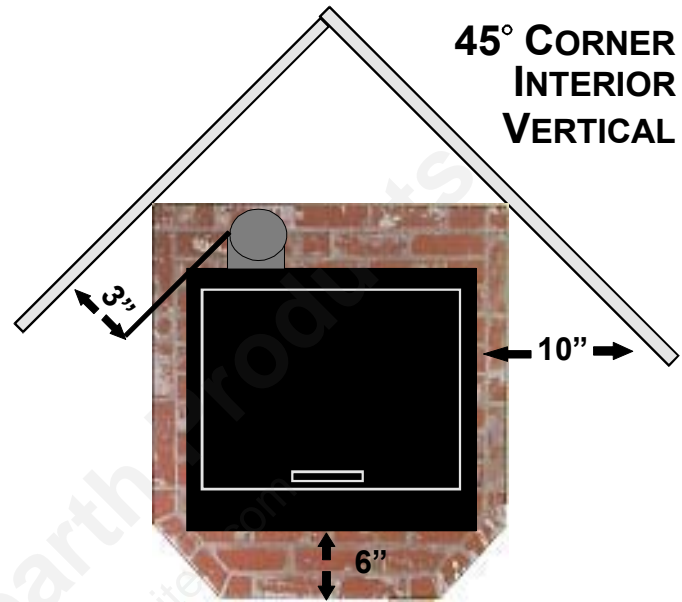

Figure 15

Note: If interior vertical vent is used, the clearance to the back wall is determined by the upward-turned elbow or “Tee”. It will vary in depth depending on the brand of PL vent used. Before placing the stove, connect the elbow or “Tee” and measure off the 3” clearance.

ALCOVE INSTALLATION:

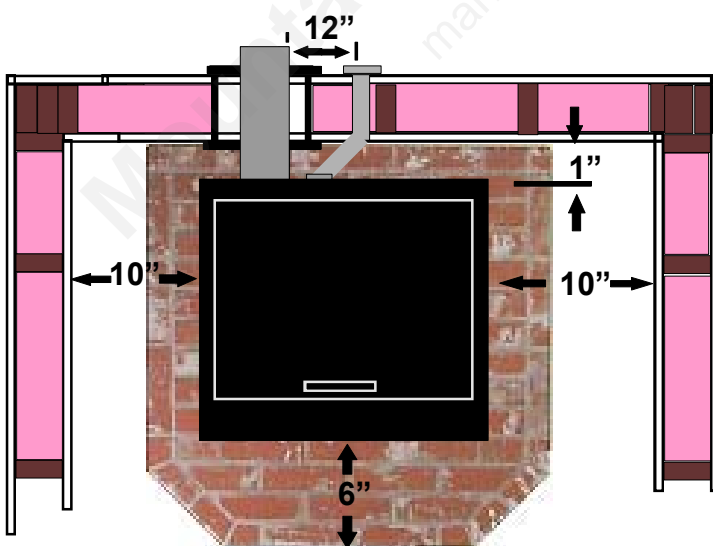

Figure 16

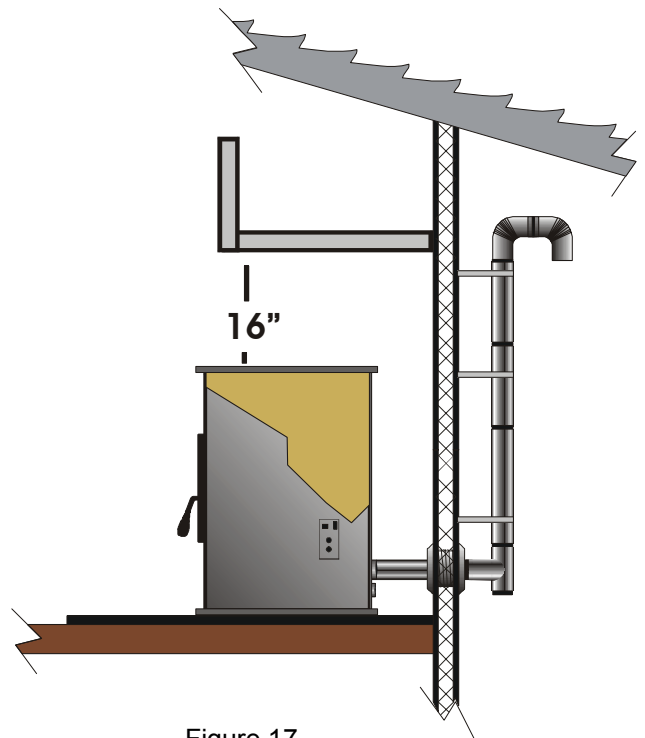

Figure 17

FREESTANDING INSTALLATION . . . continued

THROUGH THE WALL - DIRECT INSTALLATION. (Figure 18)

1. Select the location for your stove, design the exhaust system and determine the brand and size of "PL" vent to be used.
 2. Position the floor pad. (C).
 3. **INSTALL VENT AT CLEARANCES SPECIFIED BY THE VENT MANUFACTURER**
Following the "PL" vent manufacturer's specifications, mark and cut a hole through the wall to accommodate the wall thimble, (A), and the outside air pipe, (B), if outside air is to be used.
 - Install the wall thimble, (A). Be sure to run a bead of silicone around the outside edges of the wall thimble to reduce drafts. Insert the proper size of "PL" vent, (D), through the wall thimble, (A).
 - Place your stove on the floor pad, (C), close to its final position. Leave room to connect the "PL" vent to your stove. Place a bead of RTV silicone around the end of your stove's exhaust pipe, (E). Connect the "PL" vent pipe adaptor (J) onto the stove's exhaust pipe.
 - Connect the length of "PL" vent, (D), that is in the thimble, (A), onto the pipe adaptor (E). Fasten together with at least three sheet metal screws (approx. ½" in length). Place a bead of RTV silicone around the connection.
 - Place your stove in its final position on the pad. Place another bead of RTV silicone around the "PL" vent and the inside of the wall thimble, to stop cold air drafts.
- Note:** If 4" PL vent is required, use an increaser, (J), on the stove exhaust pipe.
4. On the outside of the building, place a 45 degree "PL" type elbow, (F), onto the end of the horizontal "PL" vent, (D). Optionally, place a rodent screen cap, (G), (may be required in some locals), on the end of the elbow, (F). Secure all connections using 3 sheet metal screws and run a bead of RTV silicone around all connections. Also run a bead of RTV silicone around the "PL" vent pipe and the outside of the wall thimble.
 5. If outside air is used, install the outside air pipe, (B). Seal the outside air pipe, (B), to your stove's outside air pipe, (I), with RTV silicone. Make sure the outside air pipe fits over, (**not inside**), your stove's outside air pipe. Install a wind shield (H). Run a bead of silicone around the inside and outside walls, again to reduce cold drafts.

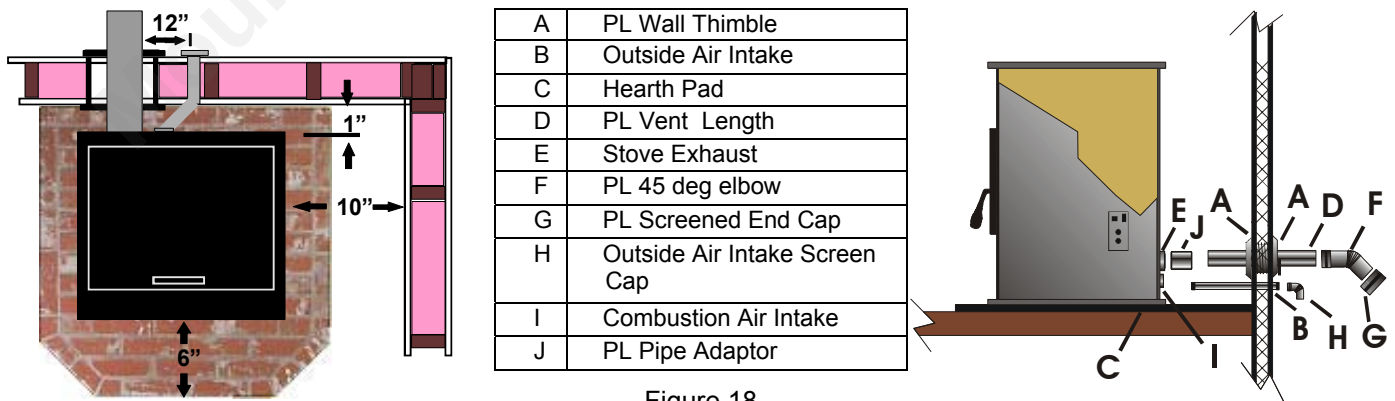

Figure 18

NOTE: Some horizontal, through the wall installations may require a Clean-Out Tee and a minimum 3' vertical rise of pipe outside the building to help draft the stove. This is required if a proper burn cannot be maintained, after the stove has been tested and the airflow set. This is due to backpressure in the exhaust, caused by the airflow around the house.

FREESTANDING INSTALLATION . . . continued

VERTICAL INSTALLATIONS: (Figures 19 - 24)

Your stove may be installed using many different vertical designs. Follow the same basic steps in locating your stove, attaching the exhaust system and outside air intake to your stove as described in "**THROUGH THE WALL – DIRECT INSTALLATION**" and the "PL" vent manufacturer's procedures for installing through a wall, ceiling, eave and roof.

COMMON, (but not inclusive), VERTICAL INSTALLATION DESIGNS ARE:

- 🔥 **VERTICAL, THROUGH THE CEILING**, through another room or space, or attic, then through the roof, terminating with a rain cap. Figure 19.
- 🔥 **VERTICAL, UP TO AN EXISTING CLASS A CHIMNEY OR MASONRY CHIMNEY**. An appropriately sized adapter will be needed when connecting onto either a Class A or into a masonry chimney. NOTE: The connection into a masonry chimney must be airtight. Figures 20, 21, and 23.
- 🔥 **HORIZONTAL, OUT THE WALL, THEN VERTICAL** to a minimum of 5 feet, into a 90-degree elbow and terminating with a 45-degree elbow pointed downward. Figure 22.
- 🔥 **HORIZONTAL, OUT THE WALL, THEN VERTICAL THROUGH THE EAVES**, then the roof, terminating with a rain cap. Figure 24.

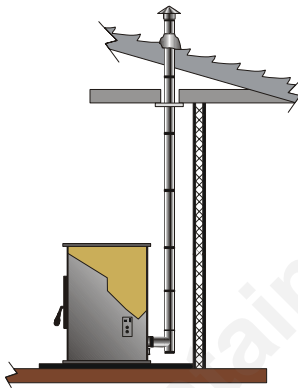

Figure 19

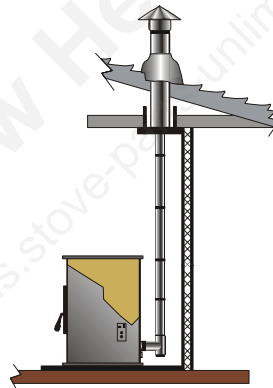

Figure 20

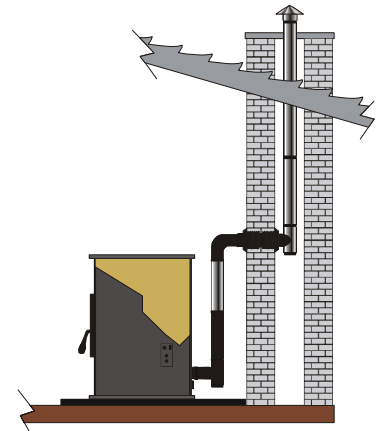

Figure 21

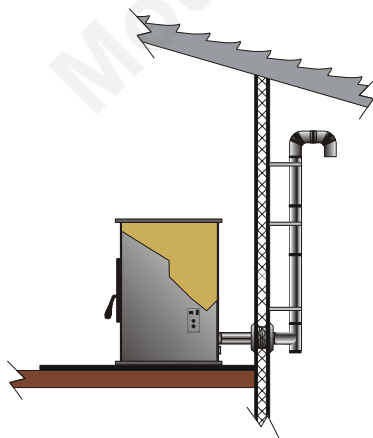

Figure 22

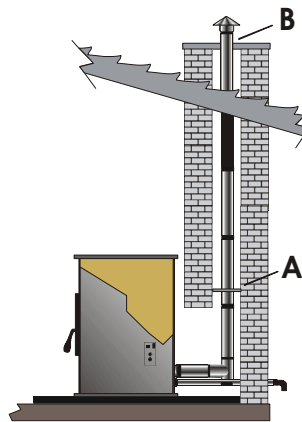

Figure 23

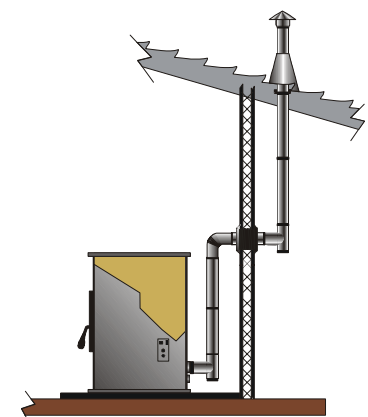







Figure 24

MOBILE HOME INSTALLATION

**CAUTION: DO NOT INSTALL STOVE IN SLEEPING ROOM
THE STRUCTURAL INTEGRITY OF THE MANUFACTURED HOME FLOOR,
CEILING/ROOF MUST BE MAINTAINED!**

Your Cheap Charlie stove has been tested and listed for mobile home installation. It may be installed in a mobile home as a "Free Standing Stove" or a "Hearth Stove", see detailed install and clearance requirements in these sections as they imply there.

In addition to all previously detailed installation requirements, mobile home installations must meet the following requirements:

-  Permanently bolt your stove to the floor, (A), figure 26.
-  Electrically ground your stove or the pedestal to the steel frame of the home. Use a number 8 gauge copper wire, (B), figure 26, or equivalent.
-  The stove must have a permanent outside air source with a ¼ inch screen over the inlet. Figure 25, (B, C & D)
-  For transportation all chimney/vent above the mobile home must be removed.
-  Chimney/PL Vent must be 3" or 4" PL Vent and must extend a minimum of 36" above the roofline of the mobile home and must be installed using a UL / ULC listed ceiling fire stop (J), figure 25, and rain cap (L), figure 25.

INSTALL VENT AT CLEARANCES SPECIFIED BY THE VENT MANUFACTURER.

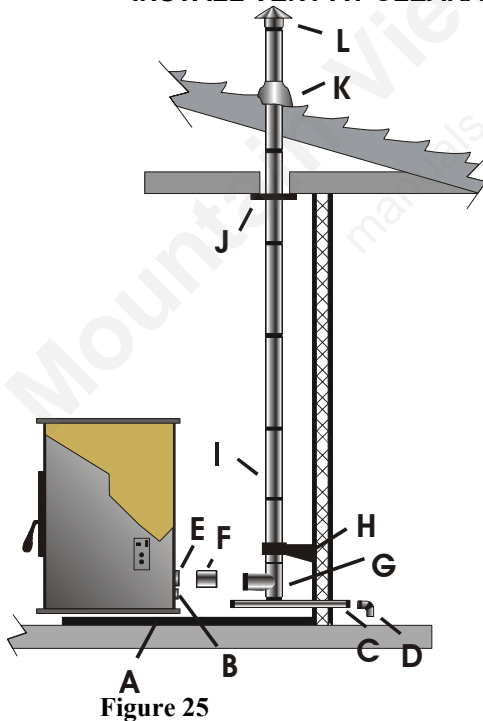

A	Floor Pad
B	Combustion Air Intake
C	Fresh Air Duct
D	Fresh Air Hood
E	Stove Exhaust
F	Pipe Adapter
G	Clean Out Tee
H	Tee Support Bracket
I	Pipe
J	Firestop Spacer / Ceiling Support
K	Roof Flashing / Storm Collar
L	Rain Cap

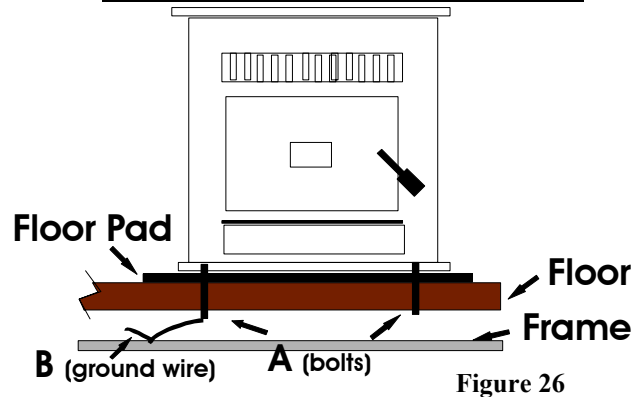





Note: When moving your Mobile Home, all exterior venting must be removed while Mobile Home is being relocated. Upon completion of relocation all venting must be reinstalled and securely fastened.

OPERATING YOUR STOVE

The operations and maintenance of your Cheap Charlie heater are unique and should not be considered to be like a wood, coal stove, gas, electric, propane or oil heater.

Cautions:

-  Do not try to operate your stove with viewing or ash pan doors open. Pellets will not feed under these circumstances and a safety concern may arise from sparks or fumes entering room.
-  Burn only pellet fuel that complies with PFI standards. Burning other types of fuels may result in the formation and leakage of Carbon Monoxide which if undetected can be deadly.
-  If you are not drawing combustion air from outside, care must be taken to allow for adequate air make up, to avoid possible room air starvation when stove or other exhaust fans are in operation.
-  It is recommended that you install a high quality smoke detector in the room where stove is installed. Care should be taken to make sure detector is in working order at all times.

HOW YOUR Cheap Charlie HEATER WORKS

Fuel in the form of wood pellets is stored in the hopper. An auger delivers the pellets to the burn grate. The fuel rate, or heat output, is set by adjusting the feed rate touch pad (settings 1 to 4). A fan provides combustion air to the burn grate. The amount of combustion air in the burn grate is adjustable, and automatically changes as the fuel rate changes. The higher the fuel rate, the larger the amount of combustion air and visa versa. The fuel burns in the burn grate, producing heat. Some heat radiates out the front and sides of your stove. The majority of the heat passes around the 13 stainless steel heat exchange tubes and air plenum around the firebox and is then moved into the room by the room air fan. A small amount of heat must pass out of your stove, along with exhaust gases, into the atmosphere.

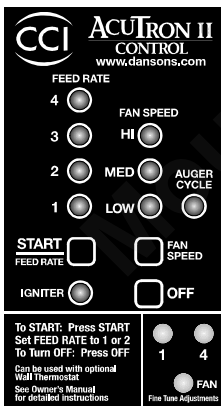

Your stove's heat output can be adjusted from settings 1-4 by using the FEED RATE touch pad available on the AcuTron control boards. The room air fan can be manually adjusted through the FAN SPEED to run faster or slower to correspond to the amount of heat being produced. The room air fan is also on a limit switch, controlled to run on high when the stove reaches higher temperatures and then resume the speed you had selected once it cools to a lower temperature.

Your stove can run efficiently over extended periods of time and at different heat output levels as long as the fuel supply is uninterrupted and **timely cleaning and maintenance is performed**. An example of how improper cleaning effects operations is; the exhaust pressure switch will shut the pellet supply off and your stove will shut off if the exhaust system becomes plugged.



Figure 27

LIGHTING YOUR STOVE

Before lighting a fire check to ensure the Burn Grate is clean and adjusted and the Ash Tray is not full.
For safety reasons use extra caution when lighting a stove that is HOT!

Lighting stove manually (No Igniter) In the NON-Thermostat Mode

1. Push firmly on the **FEED RATE** or **START** touch pad.
 - The **COMBUSTION FAN** (exhaust) will start and operate at full speed for 60 seconds, then adjust downward to match feed rate #1
 - The **CONVECTION FAN** (heating) will start and the LED will go solid on LOW setting
 - The **AUGER CYCLE** LED will go solid for 3 seconds, indicating signal being sent to auger motor.
2. Place a small amount of a solid fuel fire starter, such as those made from sawdust and wax or use wood shavings, in the bottom of the burn grate.
Add a small handful of pellets to the starter material.
Add a small amount of fire starter over the pellets.

CAUTION: DO NOT USE ANY FLAMMABLE LIQUIDS SUCH AS GASOLINE, GASOLINE-TYPE LANTERN FUEL, KEROSENE, CHARCOAL LIGHTER FLUID, OR SIMILAR LIQUIDS TO START OR FRESHEN-UP THE FIRE! KEEP ALL SUCH LIQUIDS WELL AWAY FROM THE HEATER WHILE IT IS IN USE.

3. Light the fire starter and slowly close the **MAIN DOOR**, leaving it about 1 inch open. When the pellets are burning, close and latch the main door. If the fire goes out when the main door is closed, add more fire starter, re-light the fire and leave the main door open an inch or so until the pellets start to burn, then close and latch the main door.
4. Adjust the **FUEL RATE** and the **FAN SPEED** to your desired settings you require upon completion of startup sequence.

NOTE: If the fire does not start, your stove will continue to feed pellets and the fans will run for approximately 15 minutes. The stove will then automatically shut off. If this happens, some unburned pellets will build up in the burn grate. To restart the fire, clean the excess pellets out of the burn grate and follow the above "Lighting a Fire".

NOTE: Some odors may be given off a new stove during the initial few hours of burning while the stove and the paint are being cured. These odors are not harmful. However, ventilating the room until the odors disappear is strongly recommended.

CAUTION: Never use liquid or volatile fire starters to start a fire in your stove! Do not install or operate your stove in any room where any liquid or volatile fuels or any other highly combustible items are in the air or stored in the room. These could cause a safety hazard.

Lighting stove with Auto-Igniter In the NON-Thermostat Mode

1. Push firmly on the **FEED RATE** or **START** touch pad.
 - The **COMBUSTION FAN** (exhaust) will start and operate at full speed for 60 seconds, then adjust downward to match feed rate #1
 - The **CONVECTION FAN** (heating) will start and the LED will go solid on LOW setting
 - The **AUGER CYCLE** LED will go solid for 3 seconds, indicating signal being sent to auger motor.
 - The **IGNITER** LED will light up solid and the 300 watt igniter will begin to operate.
2. On a primed **AUGER** system pellets will begin to fall into the **BURN GRATE**, and the **AUTO SELF IGNITER** will automatically ignite the pellets in approx. 3 – 5 min.
Note: If stoves fails to light within 15 minutes, shut off the stove, remove the pellets from the burn grate and repeat step 2. If stove fails to ignite a second time, disconnect and contact your dealer.
3. Adjust the **FUEL RATE** and the **FAN SPEED** to your desired settings you require upon completion of startup sequence.

THE ACUTRON CONTROLS

Basic Overview

The AcuTron II or III digital control board was designed to give you flexibility on how you want to operate your stove. The AcuTron can be operated as a **MANUAL** control or by a **THERMOSTAT**. When operating in the Thermostat option, you can also choose to run your appliance in the **ON/OFF** mode or the **LOW/HIGH** mode.

The **START** or **FEED RATE** touch pad allows electricity to flow to your stove's electrical components for 15 minutes. If after 15 minutes your stove has heated to normal operating temperatures your stove will continue to run. If the fire does not light and/or burn properly, the electricity to your stove's components will be shut off at the end of 15 minutes.

The **FAN SPEED** controls the speed of the room air fan. This fan blows room air through the heat exchange tubes and back into the room. When the **FEED RATE** is set to a higher position, the **FAN SPEED** should be set higher and visa versa. To achieve optimum heat transfer it is recommended to set the **FAN SPEED** to **LOW** when running the **FEED RATE** at 1 or 2, and Fan on **MED** on **FEED RATE** #3 or 4.

When the **START / FEED RATE** is **ON**, the **AUGER CYCLE** LED will turn on when the auger is active. When the **OFF** touch pad is pushed [**OFF**], the auger motor will not run, fuel stops feeding and the fire will die.

The **FEED RATE** works in a synchronized manner setting both the fuel rate and combustion air at the same time. When fuel is increased by setting the **FEED RATE** higher, combustion air is automatically increased and visa versa.

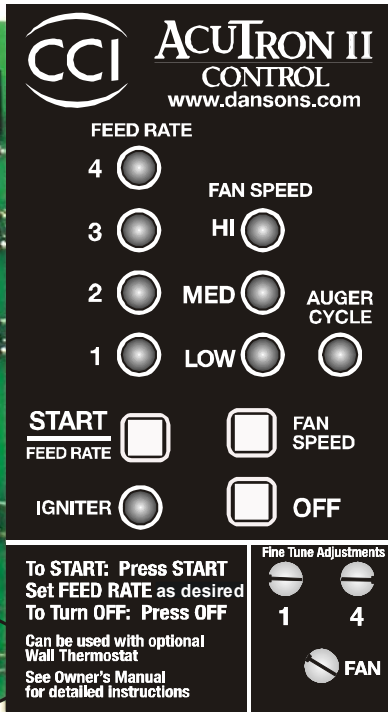

HOW THE BOARD WORKS

INITIAL START OR SET-UP (MANUAL OR NON-THERMOSTAT MODE)

Upon initial start-up the control will feed automatically at the #1 feed rate.

Press the **START** touch pad.

- Convection (heating) fan will start and the **FAN** LED will be solid on **LOW** setting
- The 300 watt Auto-Igniter will begin to glow and the **IGNITER** LED will be solid
- The **AUGER CYCLE** LED will go solid for 3 seconds, indicating signal is being sent to the auger motor.
- The Combustion (exhaust) fan will start and operate at full speed for 60 seconds, then adjust downward to match feed rate #1.

Press **FEED RATE** touch pad to select desired heat output that you require upon completion of ignition sequence.

NOTE: If you do not press the **FEED RATE** touch pad, the stove will continue to run at **FEED RATE** #1 and the LED will continue to flash at a fast rate.

When the **FEED RATE LED** is flashing at a **FAST** rate this indicates that the **LOW LIMIT (L120)** is closed. This means the unit has not reached operating temperature.

When the **FEED RATE LED** is flashing at a **SLOW** rate this indicates that the **LOW LIMIT (L120)** is open. This means the control board has entered a 5 minute "Safety Delay" mode.

After the 5 minute Safety Delay is complete

- **IGNITER** and **IGNITER** LED will turn off
- **FEED RATE** LED will become solid and the appliance will feed fuel at your selected heat output

RE-START (MANUAL OR NON-THERMOSTAT MODE)

The AcuTron II or III board does have limited memory. To restart your appliance push the **START** touch pad. The appliance will automatically go through it normal start-up then return to the **FEED** and **FAN** setting you used prior to turning off the board and appliance the last time of use.

THE CONTROLS ... CONTINUED

TRIM POTS (Fine Tune Adjustments)– Factory Settings

The **COMBUSTION FAN (FAN)**, **HI (4)** and **LO (1) FEED RATE trim pots** have been preset at the factory, but may need to be adjusted onsite after your installation is complete. Due to different installation setups, length and size of venting, and pellet fuel quality, the preset from the factory will not always be correct. These settings will accommodate virtually all wood pellet fuels.

FUEL FEED rates at the Lowest (number 1) and highest (number 4) settings can be adjusted by adjusting the fine tune trim pots located on the control panel. To **raise fuel feed** turn trim pot **counter clockwise** and to **lower** turn **clockwise**. To assist in knowing what the change is you should note the amount of time the light on the **AUGER CYCLE LED** stays OFF. (Note: The light stays on when ever the fuel feed motor, **AUGER CYCLE**, is running). **Lengthening the time this LED stays OFF lowers the fuel feed and shortening the off-time increases the fuel feed.**

COMBUSTION FAN SPEED (FAN)

In a few instances because of prevailing conditions pertinent to your specific installation, or even different batches of pellet fuel, the **COMBUSTION FAN SPEED** may be adjusted to raise or lower the amount of air moving through the grate for the cleanest burn. The **FAN** speed can be adjusted by adjusting the **FAN** trim pot **COUNTER CLOCKWISE to INCREASE** the speed and **CLOCKWISE to DECREASE** the speed of the combustion fan.

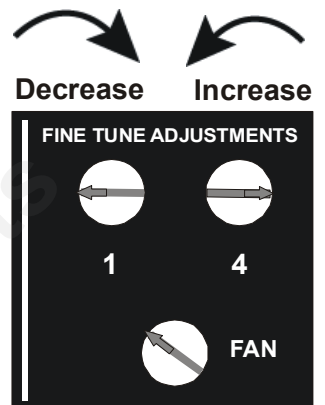

Note: If you attempt to adjust the Fuel Feed Trim Pots, use a small precision screwdriver. The Trim Pots do not make a full rotation. If using a metal screwdriver, be gentle as the plastic trim pot slot can be damaged or stripped.

FAN SPEED (Convection or heating)

The **FAN SPEED** controls the speed of the room air fan. This fan blows room air through the heat exchange tubes and back into the room. When the **FEED RATE** is set to a higher position, the **FAN SPEED** should be set higher and visa versa. When the **FEED RATE** is set at [3 OR 4] set the **FAN SPEED** to [MED]. If you forget, the room air fan's (L140) temperature limit snap switch automatically sets the fan on high when your stove is producing heat faster than the fan is carrying it into the room. This may occur when the heat control lever is set at [3 or 4] and the **FAN SPEED** is set to a very low or off setting. After the fan runs at this automatic high setting a few minutes, it may cycle back to its lower setting and may continue to cycle between [HIGH] and your selected setting. The circulation (room air) fan cycling from high to low is a normal condition, as well as a safety feature of your appliance.

AUGER CYCLE

The **AUGER CYCLE LED** indicates when a electrical signal is being sent to the auger motor. It is NOT used to indicate the actual movement of the auger. When the signal is being sent the LED will be solid for 3 seconds. When the LED is off no signal is being sent.

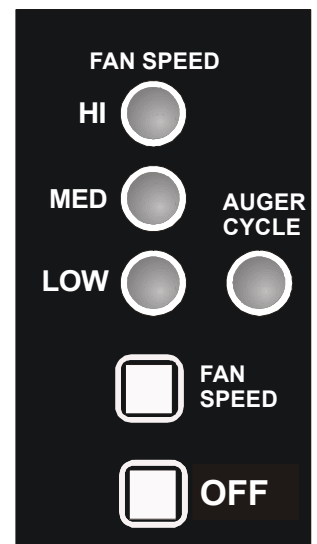

SHUTTING THE STOVE OFF

Note: DO NOT UNPLUG your stove if there is a fire going or if the stove is still active. This could result in smoke coming back into the room. Remember the **EXHAUST FAN** is needed to force the exhaust out of the stove.

On the CCI "AcuTron" Board firmly touch the **OFF** touch pad. The **FUEL RATE LED** will turn off. The **AUGER CYCLE LED** will turn off. The auger will stop feeding fuel to the fire and the **FAN** speed LED will flash indicating that the appliance is in the "Shut Down" mode. The fire will go out and the fans will continue to run until your stove cools down at which time the fans will automatically shut off and NO LED's will remain ON.

PERFORMANCE ENHANCEMENT TIPS

Quality care and **quality pellets** will help your stove operate at its peak efficiency. Consider:



If any **fin**es are noticed in the pellets or in the hopper, you may wish to screen the pellets.



Periodically check the hopper to make sure there are no fines or pellets building up in the corners of the sloping sides. Clean and polish the hopper as needed.



Be diligent in performing your **CLEANING** and **MAINTENANCE** requirements.

IT IS CRITICAL FOR THE CORRECT OPERATION OF YOUR STOVE THAT THE DAMPER, COMBUSTION FAN SPEED AND HI-LO FUEL FEED RATES BE SET CORRECTLY!

AIR INLET DAMPER:

The damper is a plate that helps control the amount of airflow supplied for combustion. With the damper pushed all the way in the airflow is at its minimum. As the damper is pulled out, more air is allowed to flow through the combustion area.

It will be necessary to monitor the appearance of the flame. Start by running your heater on HIGH (#4) setting for approximately 10 minutes, then push the damper all the way in and evaluate the appearance of the flame. If your flame is smoky red / orange with evidence of soot at the top of the flame, you need more combustion air. Continue to pull out the damper about a 1/8" at a time, opening the damper as needed to obtain a flame that is yellow and a fire that is brisk enough to carry ash out of the grate, but not so brisk that it carries pellets out as well (known as "Pop corning"). Normally you should find that the damper will need to be closed two-thirds to three quarters, but will vary with length of vent run, pellet quality and elevation.

Damper Adjustment Guideline

Lack of Combustion Air:

Symptoms of insufficient combustion air include: unburned fuel, lazy smoky or red / orange flame, excessive ash or soot, excessive buildup on glass, as well as excessive amounts of ash build up in the grate.

Contributing factors: High Altitude – Lack of oxygen, Restrictive Venting, Dirty / Poor quality fuel or the burn grate may not be seated properly.

Excessive Combustion Air:

Symptoms of excessive combustion air include: fuel burns too quickly resulting in smoking or smoldering pellets, white to yellow flame, and the burning pellets will lift off the grate and fly up into the air (popcorning)

Contributing factors: venting system providing excessive draft.

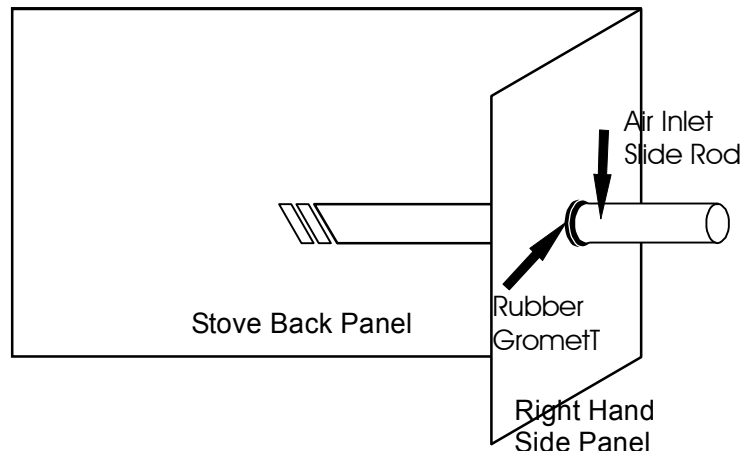

Refer to the "Trouble Shooting Guide" section of this manual, and if necessary, **contact your local Specialty Retailer, Certified HVAC Service Depot, or Dansons Group Inc. Customer Service Department at 1-866-456-9269.**

INITIAL APPLIANCE BURN SETUP

IT IS CRITICAL FOR THE CORRECT OPERATION OF YOUR STOVE THAT THE BURN GRATE, AIR INLET DAMPER, COMBUSTION FAN SPEED, AND 1 & 4 FUEL RATE BE SET CORRECTLY!

A **HIGH QUALITY FIRE** should burn with a brisk, yellow flame. A flame exhibiting a lazy, orange or sooty characteristic is a poor quality and inefficient flame. A poor flame produces less heat, increases sooting and may cause a smoky exhaust. If a poor flame exists for any period of time, clean your stove and exhaust system.

Note: if log option is purchased, do not install until initial setup is complete

START APPLIANCE AS PER LIGHTING INSTRUCTIONS,

let stove run for approx. 10 minutes before turning the stove to the # 4 setting (or High), to begin to make fine adjustments. **AUGER CYCLE indicator** should be lit "ON" for 3 seconds and "OFF" for 3-5 seconds. Adjust the **AIR INLET DAMPER**. This will have to be set, as the factory sends all units out with the damper wide open to accommodate a wide range of installations and elevations.

AIR INLET DAMPER: Slide open or close damper as needed to obtain a fire that is brisk enough to carry ash out of the grate, but not so brisk that it carries pellets out as well (known as "Pop corning"). Normally you should find that the damper will need to be closed two-thirds to three quarters, but will vary with length of vent run, pellet quality and elevation. The best way to set this is at the **FUEL SETTING #4**.

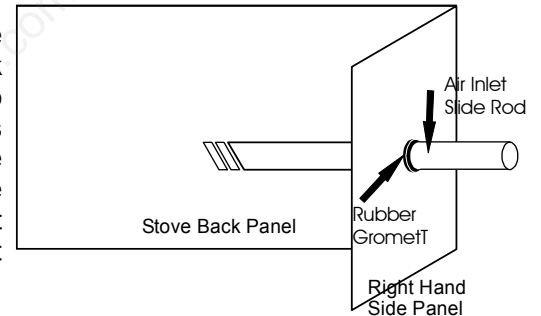

When you are pleased with the burn and how the appliance is operating, you are now ready to set the board up at **LOW** setting.

Set **FUEL RATE** to **#1 or LOW** setting. Again let this burn for approx. 10 minutes before making any adjustments. The **AUGER CYCLE** indicator should be "OFF" for approx 9 – 14 seconds between auger turnings (light ON). If "Pop corning" is taking place at this setting adjust the **COMBUSTION FAN SPEED**.

COMBUSTION FAN SPEED (Draft): In a few instances because of prevailing conditions pertinent to your specific installation, or even different batches of pellet fuel, the **COMBUSTION FAN SPEED** may be adjusted to increase or decrease the amount of air moving through the grate for the cleanest burn. Fan speed can be adjusted by adjusting the **FAN** trim pod **COUNTER CLOCKWISE** to **INCREASE** the speed and **CLOCKWISE** to **DECREASE** the speed of the combustion fan.

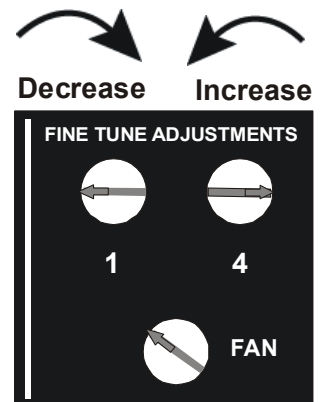

FUEL RATE: Fuel rate at the Lowest (number 1) and highest (number 4) settings can be changed by adjusting the **#1 or #4 TRIM PODS** located on the control panel. To **INCREASE** fuel rate turn trimmer **COUNTER CLOCKWISE** and to **LOWER** turn **CLOCKWISE**. To assist in knowing what changes you made, you should note the amount of time the light on the **AUGER CYCLE** stays "OFF". (Note: The light stays "off" when ever the fuel feed motor is not running). **Lengthening the time this light stays "OFF" lowers the fuel feed and shortening the "OFF" time increases the fuel feed. Factory Setting #1 light "OFF" is approx. 9-11 seconds, #4 light "OFF" is 3-4 seconds.**

PELLET FUEL

The performance of your pellet appliance is greatly affected by the type and quality of wood pellets burned. As the heat output of various quality wood pellets differ, so will the performance and heat output of your appliance.

PELLET QUALITY

Your Cheap Charlie stove, with its standard "Super Grate", is designed to burn APFI/FFI, "Premium" or "Standard" quality wood pellets. Pellets that are soft, contain excessive amounts of loose sawdust, have been or are wet, produce clinkers and/or heavy ash will result in reduced performance and may actually cause the fire to go out.

PELLET CONSUMPTION

Fuel consumption will vary somewhat between fuel brands and stoves. The following "**ROUGH GUIDE**" to pellet usage's may be useful in assessing your stove's operation, in ordering fuel and in providing information to your Authorized Cheap Charlie Dealer.

Fuel Rate Setting...

Setting	Approximate Burn Time on		Amount of pellets burned
	120 lb. hopper	300 lb. hopper	
1	40 – 80 hours	100 – 200 hours	1.50 to 3.00 lbs. Per hour
2	35 – 48 hours	86 – 120 hours	2.50 to 3.50 lbs. Per hour
3	27 – 35 hours	86 – 67 hours	3.50 to 4.50 lbs. Per hour
4	22 – 30 hours	55 – 75 hours	4.00 to 5.50 lbs. Per hour

* Fuel flow and burn times quoted are approximate. And may vary with type of fuel used.

FACTORS EFFECTING PELLET FEED RATES

Generally, the smaller, harder and cleaner, free from fines the pellets are the faster they will feed at a given setting and visa versa. The extremes in pellet size and quality can cause several hours difference in burning time for a 40 pound bag of pellets. Heat production is directly related to the pounds of fuel burned per hour. As fuel consumption goes down so will heat output and visa versa. Pellet feed rate, at the same fuel settings, may vary greatly from brand to brand and may vary somewhat from batch to batch within the same brand.

FINE TUNING THE PELLET FEED RATES

If the fire goes out at the LO (# 1) setting the pellets being used may not be feeding fast enough. Likewise if the fire is too high, i.e. burning fuel at the LO (# 1) setting the pellets being used may be feeding too fast. The fuel feed rate for each setting may be increased or decreased somewhat to accommodate different pellets

NOTE: Fine tuning the feed rates beyond the fuel settings provided, involves technical adjustments that you may wish to have performed by an **Authorized Cheap Charlie Dealer**. There may be a service charge for these adjustments.

ASH and CLINKERS

Ash is a by-product of all pellets. Clinkers may be produced from some pellets and not from others. High quality pellets will produce less ash and fewer clinkers than lower quality pellets.

ASH is a natural product of burning wood. As the amount of ash in the wood increases the amount of ash left after burning high ash wood pellets will increase.

ASH AND CLINKERS CONTINUED

CLINKERS are those solid, glassy or porous accumulations that may result from burning some types of wood pellets. Clinkers are formed in the bottom of the burn grate and if left undisturbed will accumulate and shut off the combustion air. As clinkers grow and shut off combustion air the fire becomes orange/brown and lazy. Pellets may build up in the burn grate. The firebox and window becomes sooty. Exhaust gases may become smoky.

Cheap Charlie heaters come complete with the "Super Grate" burn grate. This grate reduces the amount of clinkers formed by lower quality pellets. If ashes are quickly blown out of the grate they cannot easily stay in one spot, heat up to the melting point and fuse into a clinker. Clinkers form when pellets are of such poor quality their ashes contain minerals that easily melt under high firebox temperatures, are not blown out of the grate, and stay there until larger and larger clinkers are produced.

Since wood and the methods of handling wood used in making pellets can vary from plant to plant and year to year some clinking must always be expected. Stove owners without an "SUPER" grate must remove clinkers manually, some times several times a day. Stove owners using an "SUPER" grate and quality pellets may experience days or even weeks of burning without the need to remove any clinkers from the grate.

FINES

FINES in pellets are pieces of sawdust that were not properly formed or are the results of pellets breaking down from handling, transporting and/or storage. Fines adversely affect the operations and heat production of a pellet shop and home heater and greatly increase the requirements for daily and periodic cleaning. Fines cause pellets to feed slower thus reducing the amount of heat produced at any given heat control setting.

NOTE: It is much easier to remove fines from pellets before they are placed in the stove than it is to service your stove for a plugged hopper, jammed auger and plugged exhaust system. Pellets with excessive sawdust may be screened to remove most of the fines. Pellet screeners may be built or purchased from most pellet stove Dealers.

PFI PELLETT STANDARDS

The Pellet Fuel Institute, standards for residential quality pellets are:

Length	1.5 inches, maximum.
Diameter	.235 to .350 inches, (approx. 1/4" to 3/8").
Fines:	.2# maximum per 40# bag.
Salts:	.005 % by weight, maximum.
Ash Content:	
- Premium Quality	.75% by weight, maximum, (.3# per 40# of pellets.)
- Standard Quality	2.5% by weight, maximum, (1# per 40# of pellets.)

Check with your Authorized Cheap Charlie Dealer on the quality of pellets in your local area and for information on what can be expected from the various local brands.

NOTE: Since Dansons Group Inc. or Canadian Comfort Industries has no control over the quality of pellets that you use, we assume no liability caused by the quality of wood pellets used.

REQUIRED ROUTINE CLEANING

Proper care of your Cheap Charlie pellet shop and home heater is required for peak, sustained performance. The need for and frequency of cleaning depends on the amount of pellets burned, pellet quality, length of time since last cleaning and the quality of the fire. While becoming acquainted with your new stove and the types of local pellets, **inspect your BURN GRATE, BURN POT, HEAT TUBES, ASH PIT, and WINDOW daily and clean until a pattern of cleaning requirement is determined.** As heating demands increase the need for stove and exhaust system cleaning and ash removal will increase.

SOOT - FLY ASH:

The by products of combustion contain small particles of fly ash. Fly ash will collect in the exhaust venting system and restrict the flow of flue gases. Incomplete combustion, (such as during startup) shutdown or incorrect operation of the room heater will lead to some sort of soot formation which will collect in the exhaust system. Because of this it is important that the exhaust system be **inspected and cleaned at least once a year to determine if cleaning is needed.** It is a good practice to inspect after every 1–2 tons of pellet fuel burning.

WARNING: Disconnect the electrical cord prior to opening the sides of your stove or opening the exhaust system for any inspection, cleaning, maintenance or service work. NEVER perform any inspection, cleaning, maintenance or service on a HOT STOVE or when the electrical cord is plugged in.

EVERY 2 –3 DAYS / WEEKLY

 **BURN GRATE: [COLD STOVE ONLY]** Clean as needed, scraping off any residue that may stick to grate bottom or sides. Ensure that the holes are clean and unrestricted. **CAUTION:** When replacing the grate make sure it fits properly in the burn pot with the lip on the burn grate, toward the front of your stove.

 **BURN POT: [COLD STOVE ONLY]** Remove the burn grate. Clean out the burn pot as needed. Do not push the fly ash to the back of the pot, as this will restrict the air flow and performance of the appliance.

 **HEAT TUBES: [COLD STOVE ONLY]** With your stove's main door closed pull the HEAT TUBE SCRAPER ROD forward and backwards a few times. As different types of pellets produce different amounts of ash, cleaning the tubes enables the heat exchange to operate efficiently. **CAUTION:** On a burning stove the heat tube scraper rod will be hot.

 **ASH PIT:** Monitor the ash level on a weekly basis. Ash content is a good indication of fuel efficiency and quality. Refer to "Safety Precaution" for safe disposal of ashes.

 **WINDOW CLEANING: [COLD STOVE ONLY as hot glass may cause serious burns]** To enjoy a clear view of the fire you should clean your window as needed with a soft cloth or paper towel. You may use a glass cleaner to remove heavy build up on the window. **HOME TIP:** Dampen a piece of newsprint with water, dip this into the fly ash, then rub down the glass. This works like a charm. Do not use abrasive chemical cleaners

DO NOT OPERATE STOVE WITH BROKEN GLASS AS LEAKAGE OF FLUE GASES MAY RESULT.

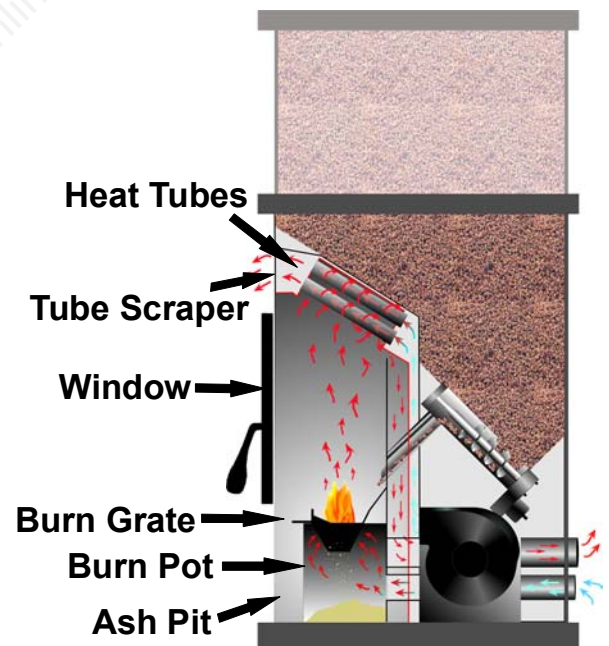



PERIODIC MAINTENANCE

With proper cleaning and the use of quality pellets, your Cheap Charlie heater requires very little maintenance. However, **the following periodic maintenance is strongly recommended.** This should be performed seasonally, bi-seasonally, or every 1-2 tons of fuel usage.

WARNING: Unplug your stove's electrical cord prior to opening the sides of the stove or opening the exhaust system for any inspection, cleaning, maintenance or service work.

NEVER perform any inspections, cleaning, maintenance or service on a HOT STOVE.

 **ASH TRAPS: [COLD STOVE ONLY]** Remove the back plate from the firebox area. This will expose the two ash traps and the fuel drop shut. Fly ash may be removed by vacuuming inside the trap areas. It is also good to use a brush (bottle cleaner) to reach up and down to scrape the build up off the metal areas.

 **BURN GRATE:** Periodically remove and clean your grate. In particular it is advisable to clean out the holes to remove any build up that may prevent air from moving through grate freely. If grate has become plugged with hard residue from burning lower quality fuel, you may need to use a sharp awl or drill bit to open holes back to their original size.

 **BURN POT:** This is the "pot" where the pellets are burned in the grate. When removing your grate for cleaning, check the burn pot area for ash build up. Some ash will fall through the grate holes and build up under the grate. This needs to be cleaned out to prevent lack of air flow through the burn grate.

 **DOOR GASKET:** Inspect the main door gasket periodically. The main door may be removed to have frayed, broken or compacted gaskets replaced by your Authorized Cheap Charlie Dealer.

 **FAN MOTORS:** Clean the in-take on CONVECTION (ROOM AIR) fan as well as the air holes on the motors of both COMBUSTION and CONVECTION fans annually. Disassemble the COMBUSTION AIR FAN and clean out the internal fan blades as part of your fall start up.

 **FRESH AIR INTAKE:** Inspect periodically to be sure that it is not clogged with any foreign materials. A plugged screen will restrict or shut off combustion air and cause a fire to die or burn poorly.

 **GOLD / BRASS TRIM CLEANING:** Use a damp cloth to clean your gold door. **DO NOT USE ANY ABRASIVE CLEANERS AS YOU WILL REMOVE OR SCRATCH THE PLATING!**

 **CHECK AND CLEAN THE HOPPER:**
Check the hopper periodically to determine if there is any sawdust or pellets that are sticking to the hopper surface. Clean as needed.

 **GLASS (High Temp, Neo-Ceram):** We recommend using a high quality glass cleaner. Should a build up of creosote or carbon accumulate you may wish to use 000 steel wool and water to clean glass. Ceramic is very hard and will not scratch from the steel wool.

 **GLASS REPLACEMENT:** In the event you need replacement only Neo-Ceram of the correct size and thickness may be used. Contact your local Cheap Charlie dealer to obtain this glass.
DO NOT OPERATE STOVE WITH BROKEN GLASS AS LEAKAGE OF FLUE GASES MAY RESULT.

PERIODIC MAINTENANCE ... CONTINUED

INSPECT AND CLEAN THE CHIMNEY: [ELECTRICAL CORD UNPLUGGED] Under some conditions fly ash build up in the chimney system may occur rapidly. The fly ash will collect in the exhaust venting system and restrict the flow of the flue gases. Incomplete combustion, such as occurs during startup, shutdown, or incorrect operation of the room heater will lead to some soot formation which will collect in the exhaust venting system. Check the clean out tees and elbows in the exhaust system periodically to determine the cleaning schedule. To remove dust from the vent pipe, tap lightly on the pipe to dislodge any loose ash. Open the bottom of the “T” to dump the ash, then vacuum as much of the ash out of the vent pipe as possible. 3 or 4-inch chimney brushes are available for chimney cleaning. If the exhaust system has a screen on it, frequently clean the screen. A plugged screen will shut off combustion air and cause a fire to die or burn poorly.

PAINTED SURFACES: Painted surfaces may be wiped down with a damp cloth. If scratches appear or you wish to renew your paint, contact your Dealer to obtain a can of Satin Black (“Stove Bright”) paint.

Tip: use a hair dryer to warm the surface prior to touching up the paint, this helps to reduce paint runs.

Note: Do not use any other brand than “Stove Bright” as they may not be compatible.

NOTE: Your Cheap Charlie Dealer may offer a periodic stove cleaning service. Check with them on timing and cost of this service.

FALL START UP: Prior to lighting the first fire check the outside area around the exhaust and air intake systems for obstructions. Clean the screens on the exhaust system and the outside air intake pipe. Turn all controls on to make sure they are working prior to lighting the first fire. Clean and remove fly ash from exhaust venting. Our local Authorized Dealer should have 3” and 4” chimney brushes available. This is also a good time to give the entire stove a good cleaning throughout.

SPRING SHUTDOWN: [COLD STOVE AND COLD ASHES ONLY]. After the last burn in the spring remove pellets from the hopper and the auger. Scoop out the pellets then run the auger until the hopper is empty and pellets stop flowing. Vacuum out the hopper. Thoroughly clean the burn grate, burn box, ashtray and ash traps. It’s desirable to spray the inside of the cleaned hopper with an aerosol silicone spray if your stove is in a high humidity area. The **exhaust system** should be thoroughly cleaned.

YEARLY SERVICING: A yearly servicing and cleaning by your Authorized Cheap Charlie Dealer is recommended. A fee may be charged for this service.

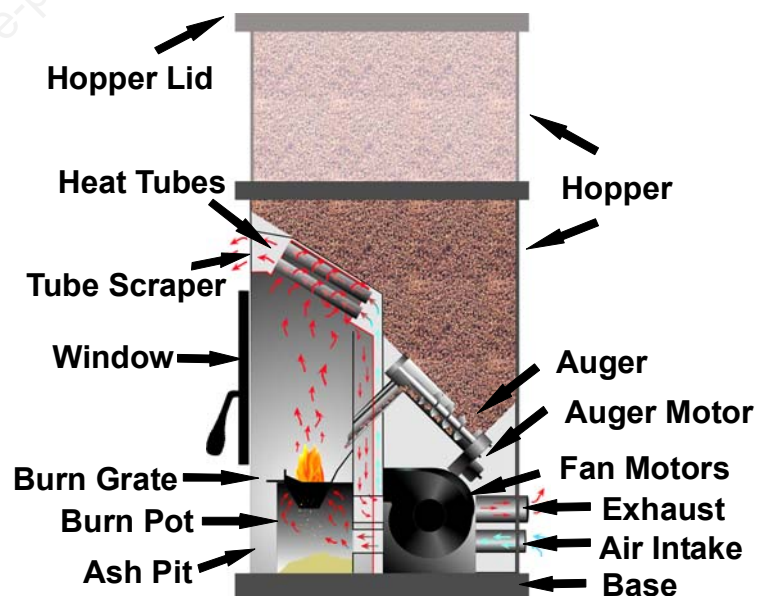

Figure 30

TROUBLE SHOOTING

Proper cleaning, maintenance and the use of quality pellets will prevent the more common stove operational problems. However, when your stove is simply operating poorly or not at all, the following trouble shooting tips may be helpful.

WARNING: Disconnect the electrical cord prior to opening the sides of your stove for any inspection, cleaning, maintenance or service work. **NEVER** perform any inspection, cleaning, maintenance or service on a **HOT STOVE**.

PROBLEM

SOLUTION

Orange, lazy flame.

- * Clean out the burn grate and burn pot.
- * Check the ash traps, clean as needed.
- * Check exhaust system, clean as needed.

Window soots.

- * Check outside air and exhaust screens, unplug if necessary.
- * Check to make sure the main door and ash door are tightly closed.

Pellets build up in burn grate.

- * Check main and ash door gaskets, replace if worn.
- * Check pellet. Replace if moist, wet, dirty or high in ash or "fines".
- * Check with your *Cheap Charlie Dealer* for service.

Fire goes out. Fans will not run when START button is pushed.

- * Check to see that your stove is plugged in and electricity is flowing from the electrical outlet.
- * Check with your *Cheap Charlie Dealer* for service.

Pellets will not feed.

- * Hopper is empty, fill the hopper.
- * Fuel switch has not been pushed to "on".
- * Auger system or controls need service.
- * Exhaust system is plugged. Clean chimney.
- * Check with your *Cheap Charlie Dealer* for service.

Stove runs 15 minutes then shuts off.

- * Start up fire did not catch, light new fire.
- * Check with your *Cheap Charlie Dealer* for service.

Fans do not shut off when stove cools down.

- * Check with your *Cheap Charlie Dealer* for service.

Ash and/or pellet dust in the house

- * Check and correct any leaks in the exhaust system.
- * Take more care in handling ashes, cleaning the window glass, opening the doors slower and pouring pellets into the hopper.
- * Check with your *Cheap Charlie Dealer* for service.

CAUTION: The electrical, auger and heat control components of your stove are not owner serviceable. Call your Authorized *Cheap Charlie Dealer* for proper diagnosis of problems and service of those components.

Note: There may be a charge for all travel, labor and parts on service calls by your Authorized *Cheap Charlie Dealer*

LIMITED WARRANTY

The Cheap Charlie wood pellet shop and home heater, carries a **five (5)** year limited warranty from the date of sale to the original owner against defects and workmanship on all steel parts, (excluding the burn grate), and **one (1)** year on electrical components. There specifically is no warranty on the paint, glass, burn grate, and all gaskets or against damage caused from corrosion.

Extended Warranty

Canadian Comfort Industries will offer an additional **one (1)** year limited warranty on electrical component parts, when your Pelpro wood pellet stove and insert is installed by a “**Dansons Certified Installer**”.

To qualify for this extended warranty the unit must be installed by a “Dansons Certified Installer” and the “**Pre-Delivery & Install Check List**” form must be filled out and received at Canadian Comfort Industries

Fax 1-780-960-0430 or online at www.dansons.com/support

There is no written or implied performance warranty on Cheap Charlie home and shop heaters as the manufacturer has no control over the installation, operations, cleaning, maintenance or the type of fuel burned.

This limited warranty will not apply if your stove has not been installed, operated, cleaned and maintained in strict accordance with the manufacturer's instructions. Burning other than quality wood pellets may void the warranty. The warranty does not cover damage or breakage due to misuse, improper handling or modifications.

Your purchase must be registered with **CANADIAN COMFORT INDUSTRIES, INC.** This can be done online at www.dansons.com/support.

All claims under this limited warranty must be made through the dealer where your heater was purchased. If an inspection by the dealer indicates that a limited warranty claim is justified, and all conditions of this limited warranty have been met, the manufacturer's total responsibilities and liabilities shall be to repair or replace, at the manufacturer's option, the defective part(s). All costs of removal, shipment to and from the dealer or manufacturer, any losses during shipment and reinstallation, and any other losses due to your stove being removed, shall be covered by the owner of the stove.

NEITHER THE MANUFACTURER, NOR THE SUPPLIERS TO THE PURCHASER, ACCEPTS RESPONSIBILITY, LEGAL OR OTHERWISE, FOR THE INCIDENTAL OR CONSEQUENTIAL DAMAGE TO THE PROPERTY OR PERSONS RESULTING FROM THE USE OF THIS PRODUCT. ANY WARRANTY IMPLIED BY LAW, INCLUDING BUT NOT LIMITED TO IMPLIED WARRANTIES OF MERCHANTABILITY OR FITNESS, SHALL BE LIMITED TO ONE (1) YEAR FROM THE DATE OF ORIGINAL PURCHASE. WHETHER A CLAIM IS MADE AGAINST THE MANUFACTURER BASED ON THE BREACH OF THIS WARRANTY OR ANY OTHER TYPE OF WARRANTY EXPRESSED OR IMPLIED BY LAW, MANUFACTURER SHALL IN NO EVENT BE LIABLE FOR ANY SPECIAL, INDIRECT, CONSEQUENTIAL OR OTHER DAMAGES OF ANY NATURE WHATSOEVER IN EXCESS OF THE ORIGINAL PURCHASE PRICE OF THIS PRODUCT. ALL WARRANTIES BY MANUFACTURER ARE SET FORTH HEREIN AND NO CLAIM SHALL BE MADE AGAINST MANUFACTURER ON ANY ORAL WARRANTY OR REPRESENTATION.

Some states do not allow the exclusion or limitation of incidental or consequential damages, or limitations of implied warranties, so the limitations or exclusions set forth in this limited warranty may not apply to you. This limited warranty gives you specific legal rights and you may have other rights, which vary from state to state.

APPENDIX “A”

INSERTING, REMOVING & ADJUSTING THE BURN GRATE

The burn grate top, (G), must fit and seal firmly on the upper lips, of the burn box, (A). An improper seal will allow incoming combustion air to escape, not passing up through the burn grate thus reducing the amount of combustion air in the area needed to efficiently burn pellets.

A Burn box

combustion air is brought into the backside and through the burn grate bottom, back, and front

- **Check periodically for fly ash build up**

-

B “SUPER” Grate

Stainless steel construction, slotted bottom and air holes on front and back

C Adjustment Tab,

- used to fine tune, and level burn grate

G Upper Grate Lip

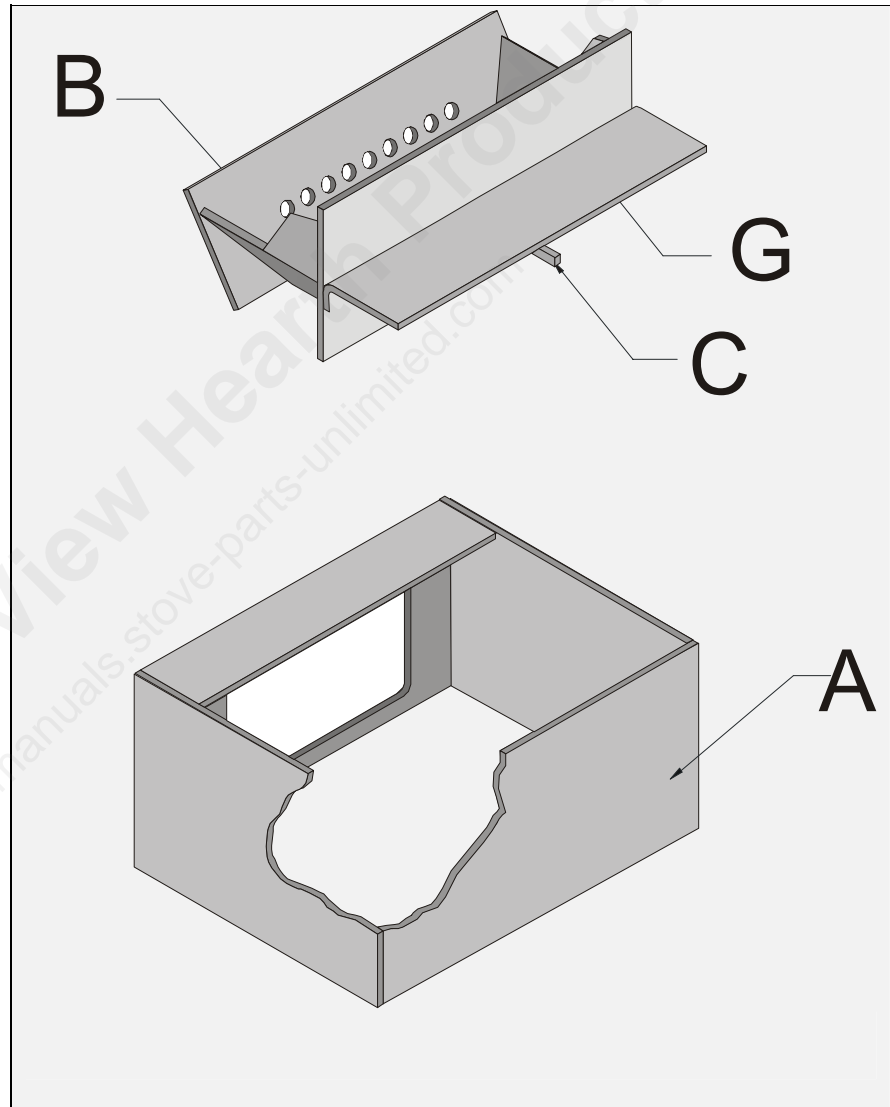

APPENDIX "A" – BURN GRATE ... CONT.

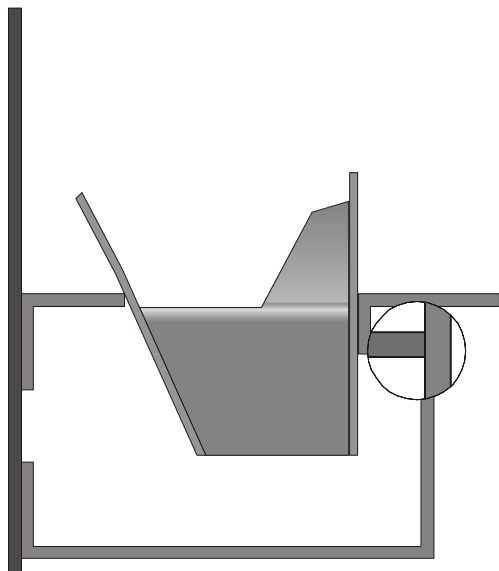

Adjust the burn grate top so that the the burn grate top sits firmly on the top of the burn box and level.

Removal of burn grate top:

- (1) Lift upward while sliding lip out from under lip of slide
- (2) then pull out toward outside of burn box
- (3) Installation is reverse of this.

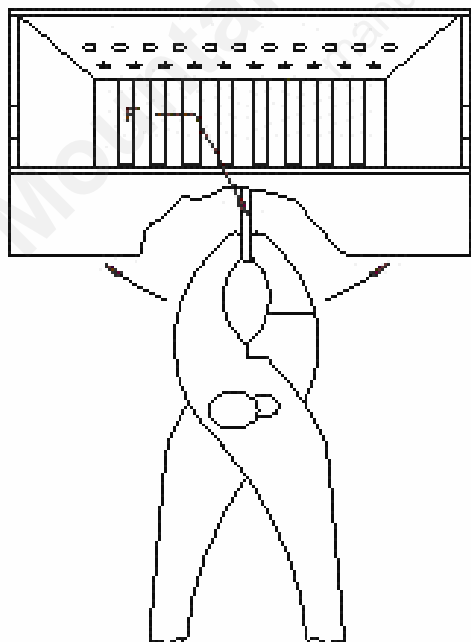
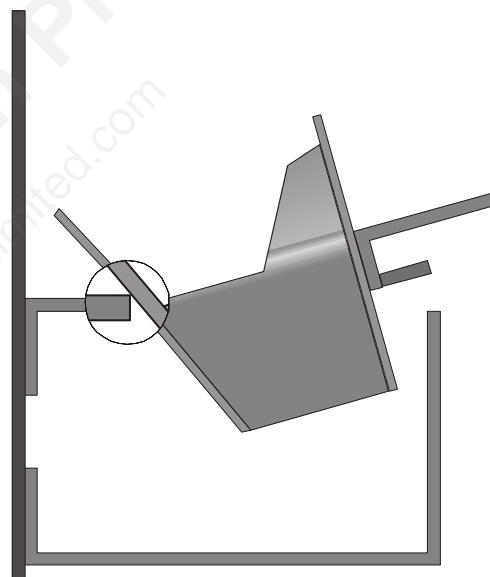

Grasp the burn grate adjustment tab, with a pair of pliers and bend it slightly to left or right (and re-install into burn box) until its length allows the burn grate top to rest tightly onto the burn grate bottom

Appendix “B”

IT IS CRITICAL FOR THE CORRECT OPERATION OF YOUR STOVE THAT THE DAMPER, COMBUSTION FAN SPEED AND HI-LO FUEL FEED BE SET CORRECTLY!

AIR INLET DAMPER:

The damper is a plate that helps control the amount of airflow supplied for combustion. With the damper pushed all the way in the airflow is at its minimum. As the damper is pulled out, more air is allowed to flow through the combustion area.

It will be necessary to monitor the appearance of the flame. Start by running your heater on HIGH (#4) setting for approximately 10 minutes, then push the damper all the way in and evaluate the appearance of the flame. If your flame is smoky red / orange with evidence of soot at the top of the flame, you need more combustion air. Continue to pull out the damper about a ¼” at a time, opening the damper as needed to obtain a flame that is yellow and a fire that is brisk enough to carry ash out of the grate, but not so brisk that it carries pellets out as well (known as “Pop corning”). Normally you should find that the damper will need to be closed two-thirds to three quarters, but will vary with length of vent run, pellet quality and elevation.

Follow the same procedure but at LOW (#1) setting as well. This will now give you your approximate damper settings needed to run your heater efficiently.

Damper Adjustment Guideline

Lack of Combustion Air:

Symptoms of insufficient combustion air

include: unburned fuel, lazy smoky or red / orange flame, excessive ash or soot, excessive buildup on glass, as well as excessive amounts of ash build up in the grate.

Contributing factors: High Altitude – Lack of oxygen, Restrictive Venting, Dirty / Poor quality fuel or the burn grate may not be seated properly.

Excessive Combustion Air:

Symptoms of excessive combustion air include: fuel burns too quickly resulting in smoking or smoldering pellets, white to yellow flame, and the burning pellets will lift off the grate and fly up into the air (popcorning)

Contributing factors: venting system providing excessive draft.

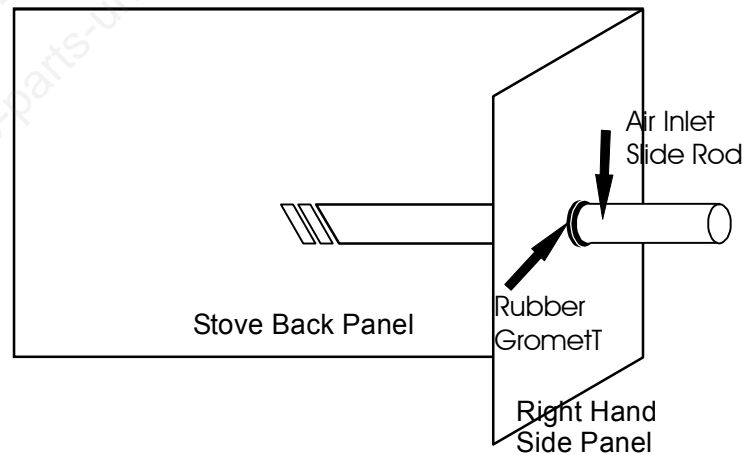

COMBUSTION FAN SPEED (Draft): In a few instances because of prevailing conditions pertinent to your specific installation, or even different batches of pellet fuel, the **COMBUSTION FAN SPEED** may be adjusted to raise or lower the amount of air moving through the grate for the cleanest burn. Fan speed can be adjusted by adjusting the **FAN POD**. **COUNTER CLOCKWISE to INCREASE** the speed and **CLOCKWISE to DECREASE** the speed of the combustion fan.

You may wish to use a qualified technician if you are not comfortable changing these settings. There may be a charge for this setting. Check with your Cheap Charlie Dealer for details.

APPENDIX “C”

OPTIONAL ACCESSORIES

CONTACT YOUR Cheap Charlie DEALER FOR MORE INFORMATION
OR TO ORDER.

PRODUCT	PART NUMBER
Acu-Tron Wall Thermostat Kit – Can. Includes: Thermostat module, wall thermostat, and 25’ 18 gauge bell wire - Celsius	ACWTKTC
Acu-Tron Wall Thermostat Kit – USA Includes: Thermostat module, wall thermostat, and 25’ 18 gauge bell wire – Fahrenheit	ACWTKTF
Small View Shop Door Assembly – Black - large pin	AHDRBAS
Large View Door Assembly – Black	ACDRBAS
Large View Door Assembly – Gold Trim	ACDRGAS
Fresh Air Kit – M/F 3’ x 2” alum duct, hood, and 2 gear clamps	ACFAKT3
Fresh Air Kit – Basement 10’ x 2” alum duct, hood, and 2 gear clamps	ACFAKT10
300 Watt Auto-Igniter Assembly	AHIGNAS
Log Set – Handcrafted 1pc. Stainless Steel	ACLOGCL1
Wall Thermostat – Canadian version	ACWTC
Wall Thermostat – USA version	ACWTF

APPENDIX "D"

REPLACEMENT PARTS

Assembly Packages	
Auger Motor	ACAMTRAS
- includes (1) 2.1 RPM Gear Motor, (1) Auger Motor Bracket w/screws	
Auger Shaft	ACAUSHAS
- includes: shaft and flighting	
Combustion Fan	ACCBFNAS
- includes: (1) Draft Induction Fan, (1) Aluminum Adapter w/screws, (1) 1/8" Fibreglass	
Convection Fan	ACCVFNAS
- includes (1) Centrifugal Blower, (1) 1/8" Fibreglass Paper Gasket	
Igniter	ACIGNAS
- includes (1) 300 watt Ceramic Igniter, (1) igniter Tube Assembly	
Body Panels	
Right Side CC JR/Franklin Panel	MHJRP
Right Side CC SR Panel	MHSRP
Left Side CC JR/Franklin Panel	MHJLP
Left Side SR Panel	MHJLP
Hopper Lid	MHHOPL
Back Side Slotted Stove Panel	MHBSLP
Ash Compartment Cover	MHACC
Control Panels - Complete	
CCI100 - Start Button, Fuel Feed	AHC100CAS
CCIAT - Acutron Digital Board	ACCATCAS
Door Assembly	
Door c/w neo-ceramic glass, Small View - Black	AHDASBD
Door c/w neo-ceramic glass, - Large View - Black	ACDABD
Door c/w neo-ceramic glass, - Large View - Brass Trim	ACDABTD
Gaskets	
Glass Gasket -	ACGLGA
Door Gasket - 60"	AGDRGA60
Combustion Fan - 1/8" Fibreglass Paper Gasket	ACCBFGA
Convection Fan - 1/8" Fibreglass Paper Gasket	ACCVFGA
Ash Door Gasket -	AGADGA
Glass	
Neo-Ceramic - plain - Large View	AGNCGP
Neo-Ceramic - plain - Small View	
Neo-Ceramic-Large View- etched - Cheap Charlie logo	AGNCGE
Grates	
Grate - "Super Grate"	ACSLGR

Kits	
Dealers Parts Kit - CCI100 Board - 1of each fan, motor, timers, igniter, board, electrical, switches and grate	AGDPKTSB
Dealers Parts Kit - CCIAT Board - 1of each fan, motor, electrical, igniter, board and grate	AGDPKTAT
Dealers Stove Analysis Kit	AGDSAKT
- draft guage, volt meter, test board for SB and AT Boards	
Dwyer Draft Gauge	ACDDG
Volt Meter	ACCVLTM
Knobs & Handles	
Door Spring Handle - Brass	ACDSHB
Fuel Control Knob	ACFLCKN
Damper Spring Handle - Brass	ACDPSHB
Switches	
Low Limit Switch - SE-L120	ACLSW120
High Limit Switch - SE-L250	ACHSW250
Igniter Limit Switch - SE-F140	ACISW140
Pressure Switch -	ACPRSW
Push Button Start Switch	ACSTSWPB
Fuel Potentiometer Switch	AHFPSW
Timer Blocks	
Timer Block - 30 minute	ACTMR30M
Timer Block - 3 second	ACTMR03S
Wire	
Wire Harness - CCISB - Main Assembly - with igniter	ACSBMNVH
Wire Harness - CCISB - Control Box Assembly	ACSBPWH
Wire Harness - CCIAT - Main Assembly - with igniter	ACATMNVH
3 Prong Plug Power Cord w/ ends	ACPWCAS
Wall Thermostat Kit - Complete Assembly	
CCIAT - Control Board, Thermostat Module, 25' 18/2 bell wire, wall thermostat (white deg C)	ACWTKTAC
CCIAT - Control Board, Thermostat Module, 25' 18/2 bell wire, wall thermostat (almond deg F)	ACWTKTAF
Wall Thermostat Kit - Add-on	
Thermostat Module, wire, wall thermostat (white Deg C)	ACWTKTC
Thermostat Module, wire, wall thermostat (white Deg F)	ACWTKTF

SEE YOUR Cheap Charlie DEALER FOR ADDITIONAL INFO

APPENDIX "E"

ACU TRON II OR III CONTROL Wall Thermostat (option)

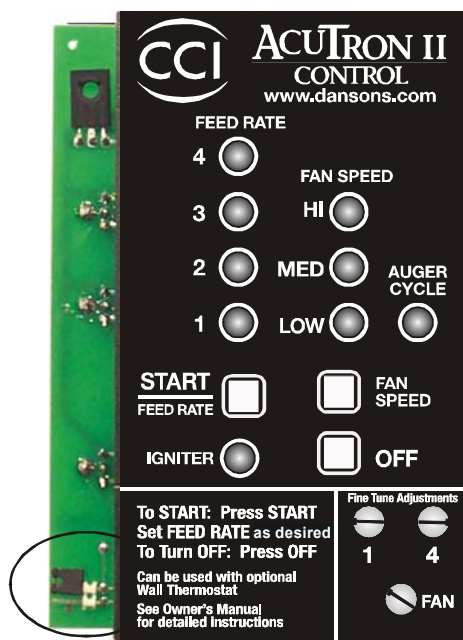

OPERATION

Your pellet appliance is capable of running in an automatic mode with the use of a wall thermostat. The "AcuTron" gives you a choice, "ON / OFF on Demand" or "LOW / HIGH". The ON / OFF mode automatically turns the heater On and will Shut Off on demand. The LOW / HIGH mode will keep your heater active and cycle between #1 (LOW) setting and your selected (HIGH) setting.

In most circumstances the BEST operation, and recommended, under thermostat control is the LOW / HIGH cycle.

Upon Start Up, in thermostat mode, the default running mode will be the LOW / HIGH mode.

When operating in either mode should your unit run out of pellet fuel it will automatically go through the normal SHUT DOWN cycle. After completing the SHUT DOWN cycle the appliance will try to restart one time only before shutting off completely, till you refill the hopper and reactivate the FUEL FEED pad.

TO CHANGE BETWEEN THE TWO MODES,

Press and hold the OFF touch pad firmly, for 3 to 5 seconds, when the FEED RATE LED's #3 and #4 flash together this indicates the thermostat will run in the HIGH / LOW cycle. When the #1 and #2 LED's flash together this indicates the ON / OFF cycle has been chosen.

HIGH / LOW CYCLE Option (Flashing 3 & 4)

Once this mode has been selected, you simply press the START touch pad to activate the stove. You can now select the HIGH heat output level (2,3 or 4) by pushing the START / FEED RATE touch pad, you can also select the FAN setting you desire. When you have selected your high level and fan speeds the LED's will continue to flash. The appliance will automatically start at the #1 feed rate until the Start-up procedure is complete.

The LOW (number 1) or selected High (2,3 or 4) Feed Rate indicator light will light up depending on if the thermostat is calling for heat or not. When the desired room temperature is reached the stove will automatically go into the low heat (#1) cycle. When the temperature in the room drops to the level set at the thermostat, the stove will again cycle to the HIGH (#2,3 or 4) preselected setting. For optimum heat transfer, the FAN setting should be set at LOW or MEDIUM. The appliance will run the FAN at HIGH speed when needed, automatically.

ON / OFF Option (Flashing 1 & 2)

To activate the thermostat to the ON / OFF feature, press and HOLD the OFF touch pad. If the FEED numbers 3 & 4 flash together, you will need to push and hold the OFF touch pad a second time. The numbers 1 & 2 will flash together to indicate that this is the cycle you are in. You can now select the HIGH heat output level (2,3 or 4) by pushing the START touch pad, you can also select the FAN setting you desire. The stove will now go through its normal start up cycle. Once completed the appliance is now in the ON / OFF mode.

The thermostat should be set for the desired room temperature. If the room temperature drops below the level on the thermostat the stove will automatically begin the start-up cycle, as explained in the manual operation section.

Once the start-up cycle is completed the stove run on the pre-selected "HIGH" (number 2,3 or 4) setting, till the temperature is reached. For optimum heat transfer, the FAN setting should be set at LOW or MEDIUM. The appliance will run the FAN at HIGH speed when needed, automatically.

When the desired room temperature is reached the stove will automatically go into the shut down cycle. The pellet feed will stop and the blowers will continue for a controlled time allowing safe shut down of your heater. When the temperature in the room drops to the level set at the thermostat, the stove will again begin the start-up cycle and resume automatic operation.

The Feed Rate numbers 1 & 2 will flash while the appliance is in the OFF part of this mode to give you a visual indication that the appliance is still active and in the ON / OFF cycle.

APPENDIX “E” ... continued

INSTALLATION

NOTE: Always Disconnect Power Before Performing the Thermostat Installation

A 24 volt wall thermostat and 25 feet of 18 gage thermostat wire is included in your heaters accessory package. It is recommended that the thermostat and thermostat wire be installed by an authorized Cheap Charlie dealer.

Tools Needed

¼” Hex Nutsetter & Driver
Wirestripper
Smaller size Flat Head Screwdriver

Installation Steps

Follow the thermostat manufactures installation procedures for the Heating Thermostats

1. Unplug stove power cord from the wall outlet.
2. To gain access to the inside of the stove, remove the six x ¼” hex screws from the slotted back access panel.
3. Unscrew the control board from the side of the heater. 2 x ¼” hex screws.
4. Locate the thermostat terminal block, marked T’STAT INPUT, found on the back of the board (see figure 31).
5. Be sure to run the thermostat wires through one of the slots of the rear access panel, before connecting the wires.
6. Connect the two wires from your thermostat to the terminals (one per terminal). Ensure the wires are firmly connected.
7. Connect the two wires at your wall thermostat to their terminals. Ensure these are firmly connected.
8. Remove the black two prong jumper, (see figure 32), located on the front, left hand side, near the bottom corner and reconnect it to only one of the posts. (see figure 33).
9. Reinstall the control board and the slotted rear access panels.
10. Plug in the stove and you are ready to operate with your thermostat!



figure 31

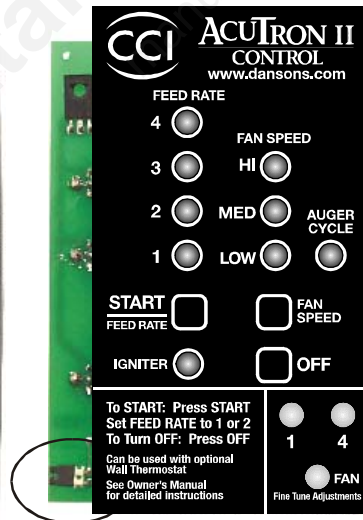

figure 32

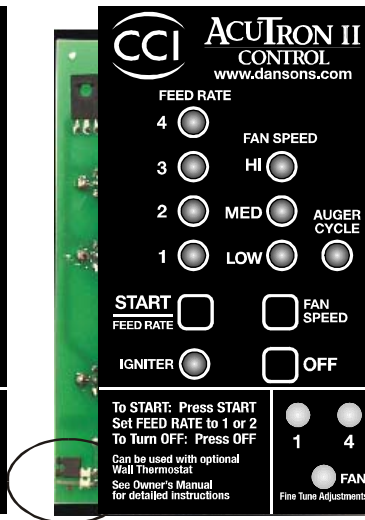

figure 33



figure 34

IMPORTANT: IF THE WALL THERMOSTAT PROVIDED IS NOT USED, THE JUMPER IS REQUIRED FOR THE STOVE TO OPERATE IN MANUAL MODE (SEE FIGURE 32).

Appendix “F”

Hopper Clean-Out Drop Chute



You would have found this along with your Owner's Manual, video and inspection card. This can have two purposes. The main one is to be an attachment to the side of the hopper to help with cleaning out the hopper. The second purpose would be used as a dust pan for your shop.

Keep this separate till needed.

Purpose:

Should you find it necessary to remove the pellets from your hopper, for any reason, this handy attachment will save time and a lot of effort.

Tools Needed:

¼" Hex Nut setter & Driver or Flat Head Screwdriver
Pail or bin

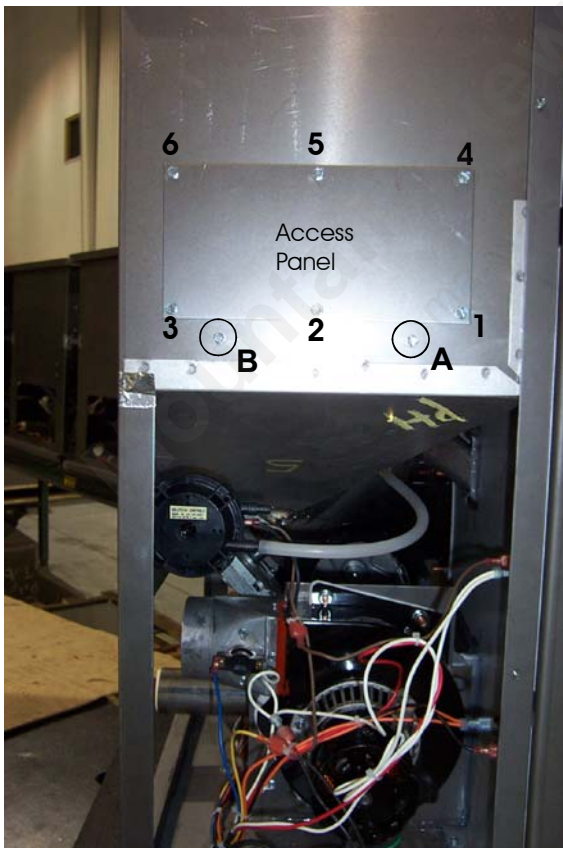

How to Install:

1. Unplug the appliance power cord from the wall outlet.
2. To gain access to the inside of the appliance, remove the ¼" hex screws from the LEFT HAND SIDE PANEL (looking from the front of the heater). These are located on the back left hand side corner of the appliance.
3. Remove the panel simply by sliding it back toward the exhaust.
4. Remove the 2 – ¼" hex screws, labeled A & B.
5. Install the Hopper Drop Chute, re-installing the screws.
6. Remove the 5 - ¼" hex screws from the side hopper access panel. Number 1 – 5 (see picture)
7. Loosen the #6 screw, but leave it attached. This now allows the access panel to act as a door.
8. Place a catch pail under the drop chute.
9. Raise and lower the access panel as needed.
10. When finished cleaning out as many pellets as possible, re-install the 5 screws, remove the drop chute, replace the 2 screws and then install the side panel.

Toll Free Technical Support
1 - 866 - 456 - 9269

Service & Maintenance Log

DEALER:		PURCHASER'S NAME:	
ADDRESS:		ADDRESS:	
CITY: STATE/PROV:		CITY: STATE/PROV:	
CONTACT: PHONE #:		ZIP/PC: PHONE #:	
PURCHASE DATE:	INSTALL DATE:	INSTALLED BY:	
STOVE MODEL:	SERIAL NUMBER:	WAS UNIT PRE BURNED:	
SPECIAL COMMENTS:			

MAINTENANCE LOG

SERVICE DATE	TECHNICIAN	DESCRIPTION OF WORK DONE

Have you registered your purchase? _____ **See www.dansons.com/support**

Has Dealer / Installer gone over the operation and maintenance of appliance? _____