



SERVICE MANUAL

ACUTRON 4 APPLIANCES



PELPRO TROUBLESHOOTING MANUAL

INTRODUCTION

The purpose of this troubleshooting guide is to provide step by step procedures for diagnosing issues with the PelPRO Acutron 4 appliances. A digital or analog multimeter will be required for many of the troubleshooting steps in this guide.

When troubleshooting with the multimeter, it's important to disconnect the appliance from wall power while locating the electrical connections that need to be checked. Connect the multimeter to the test locations detailed in this guide and then plug the appliance back into wall power. Take care to avoid letting any exposed wires or connectors from contacting the metal chassis of the appliance or from touching exposed skin. The appliance is energized with 115VAC power from the wall and there is a risk of shock or electrocution. If you are not familiar or comfortable working with energized electrical circuits, please contact a certified NFI Installer or certified electrician to complete that portion of troubleshooting.

When instructed to check a appliance for power from the control board, the multimeter will need to be set to check Voltage, often displayed as "V" on the meter. If the meter is not auto-sensing, AC voltage will need to be chosen when specified in the instructions. AC voltage is also sometimes shown as ~ V on multimeters. If instructed to check VDC, DC voltage will have to be chosen on the multimeter. Voltage checks are typically used when motors and blowers are not running and we are attempting to determine if the component is bad or is the control board is not sending power to the component.

Some components can be verified for functionality by checking the resistance of the part. Igniters and fuses are the most common parts that can be verified by resistance checking with a multimeter. Resistance is measured in ohms (Ω) and most multimeters will have that symbol next to the resistance setting. Unlike voltage, resistance is always measured with the appliance completely deenergized from wall power. There is no risk of shock or electrocution when the appliance is unplugged from wall power and components are being verified for resistance. When resistance is being checked, this manual will provide an expected resistance in Ω , however a number slightly above or below the specified value does not indicate a bad component. If the multimeter shows MAX or Out of Range, this indicates infinite resistance, meaning an open circuit and a bad component. A resistance of 0 ohms for a component indicates an electric short circuit and again a bad component.

TABLE OF CONTENTS

Acutron 4 Service Parts List	Page 4
Acutron 4 Parts Location	Page 16
Acutron 4 Operation Flow Chart	Page 17
Acutron 4 Troubleshooting	Page 20
Acutron 4 Repair Instructions	Page 32
Acutron 4 Specification Sheet	Page 53

Mountain View Hearth Products
manuals.stove-parts-unlimited.com

ACUTRON 4 STOVES AND INSERTS

Model Name	Model Number	Manual Number
Step Top	FPPST4BD-M	7081-147
Home Heater Deluxe 120	HHP2BDD-M	7081-146
Home Heater 300	HHP32BD	7081-146
Freestanding	FPP2BD-M	7081-148
Bayview	FPPBW2GD	7081-148
Bayview Insert	IPPBW2GD	7081-148



Freestanding



HH120



HH300



Bayview



StepTop



Bayview



Service Parts

Pellet Stove
FPPBW2GD

BAY VIEW

Beginning Manufacturing Date: NA
Ending Manufacturing Date: Active



IMPORTANT: THIS IS DATED INFORMATION. When requesting service or replacement parts for your appliance please provide model number and serial number. All parts listed in this manual must be ordered from a dealer.



Stocked at Depot

ITEM	DESCRIPTION	COMMENTS	PART NUMBER	
	Acutron 4 Control Board		KS-5040-1101	Y
	Auger Shaft Assembly		KS-5010-1020	Y
	Acutron Wire Harness, 9 Pin Main Assembly		KS-5110-1350	Y
	Auger Bushings		KS-5010-1030	Y
	Brick Holder		KS-5050-1140	Y
	Burn Grate		KS-5080-1240	Y
	Combustion Fan w/Gasket		KS-5020-1040	Y
	Gasket , Combustion, 1/8" Fiber Glass Paper		KS-5060-1170	Y

Additional Service parts on following page

2/15



Beginning Manufacturing Date: NA
Ending Manufacturing Date: Active

IMPORTANT: THIS IS DATED INFORMATION. When requesting service or replacement parts for your appliance please provide model number and serial number. All parts listed in this manual must be ordered from a dealer.



Stocked at Depot

ITEM	DESCRIPTION	COMMENTS	PART NUMBER	Stocked at Depot
	Convection Fan Assembly w/Gasket	Pre Sept 2013	KS-5020-1050	Y
		Post Sept 2013	KS-5020-1052	Y
	Gasket , Convection Fan, 1/8" Fiber Glass Paper		KS-5060-1180	Y
	Dart Clamps		KS-5250-1692	Y
	DHC Control Replacement, 12 Pin		KS-5040-1091	Y
	Fire Brick Holder		KS-5050-1140	Y
	Exhaust Manifold w/Gasket, 2 pieces		KS-5210-1652	Y
	Feed Shaft & Motor	Post May 2013	KS-5010-1031	Y
	Firebrick Panel, 1 Piece, Rear		KS-5050-1130	Y
	Gasket, Ash Door		KS-5060-1200	Y
	Gasket, Door, 5/8" x 60"		KS-5060-1160	Y
	Gasket, EZ Connect, 1/8" Fiber Glass Paper		KS-5060-1190	Y
	Glass, Ceramic 9.25" x 14.5"	Center	KS-5070-1220	Y
	Glass, Ceramic 4" x 9.25"	Side	KS-5070-1230	Y
	Handle Assembly		KS-5140-1447	Y
	Handle Latch		KS-5140-1446	Y
	Handle, Coil Spring Brass		KS-5140-1441	Y
	Hopper Lid Safety Switch		KS-5100-1342	Y
	Ignitor Assembly, Includes 300 watt ceramic ignitor and ignitor tube assembly		KS-5030-1060	Y
	Ignitor Cartridge - 300 Watt		KS-5030-1061	Y
	Kit Hinge Pins STD Door		KS-5190-1601	Y
	Kit Switch Snap SE-L120		KS-5100-1340	Y
	Limit Switch, F125, Convection Fan		KS-5100-1320	Y
	Limit Switch, L250		KS-5100-1330	Y
	Lock Collar 5/8"		KS-5010-1021	Y
	Side Panel Insert	Right	KS-5250-1690	Y
		Left	KS-5250-1691	Y
	Thermostat Kit		KS-5120-1361	Y
	Vacuum Switch, Plastic		KS-5090-1300	Y
	Kit, Glass Gasket		KS-5060-1151	Y
	Kit Auger Motor	Post May 2013	KS-5010-1011	Y
Accessories				
	Fresh Air Kit - Basement - 10' x 2" Aluminum Duct & Hood		KS-5150-1460	Y
	Fresh Air Kit- M/F - 3' x 2" Aluminum Duct		KS-5150-1450	Y
	Log Set		KS-5160-1470	Y



Service Parts

Pellet Insert
IPPBW2GD,

BAY VIEW INSERT

Beginning Manufacturing Date: NA
Ending Manufacturing Date: Active



IMPORTANT: THIS IS DATED INFORMATION. When requesting service or replacement parts for your appliance please provide model number and serial number. All parts listed in this manual must be ordered from a dealer.



**Stocked
at Depot**

ITEM	DESCRIPTION	COMMENTS	PART NUMBER	
	Acutron 4 Control Board		KS-5040-1101	Y
	Auger Shaft Assembly		KS-5010-1020	Y
	Acutron Wire Harness, 9 Pin Main Assembly		KS-5110-1350	Y
	Auger Bushings		KS-5010-1030	Y
	Brick Holder		KS-5050-1140	Y
	Burn Grate		KS-5080-1240	Y
	Combustion Fan w/Gasket		KS-5020-1040	Y
	Gasket , Combustion, 1/8" Fiber Glass Paper		KS-5060-1170	Y

Additional service parts on following page

2/15



Service Parts

BAY VIEW INSERT

Beginning Manufacturing Date: NA
Ending Manufacturing Date: Active

IMPORTANT: THIS IS DATED INFORMATION. When requesting service or replacement parts for your appliance please provide model number and serial number. All parts listed in this manual must be ordered from a dealer.



**Stocked
at Depot**

ITEM	DESCRIPTION	COMMENTS	PART NUMBER	
	Convection Fan Assembly w/Gasket	Pre Sept 2013	KS-5020-1050	Y
		Post Sept 2013	KS-5020-1052	Y
	Gasket , Convection Fan, 1/8" Fiber Glass Paper		KS-5060-1180	Y
	Dart Holder		KS-5250-1692	Y
	DHC Control Replacement, 12 Pin		KS-5040-1091	Y
	Fire Brick Holder		KS-5050-1140	Y
	Exhaust Manifold w/Gasket, 2 pieces		KS-5210-1652	Y
	Feed Shaft & Motor	Post May 2013	KS-5010-1031	Y
	Firebrick Panel, 1 Piece, Rear		KS-5050-1130	Y
	Gasket, Ash Door		KS-5060-1200	Y
	Gasket, Door, 5/8" x 60"		KS-5060-1160	Y
	Gasket, EZ Connect, 1/8" Fiber Glass Paper		KS-5060-1190	Y
	Glass, Ceramic 9.25" x 14.5"	Center	KS-5070-1220	Y
	Glass, Ceramic 4" x 9.25"	Side	KS-5070-1230	Y
	Handle Assembly		KS-5140-1447	Y
	Handle Latch		KS-5140-1446	Y
	Handle, Coil Spring Brass		KS-5140-1441	Y
	Hopper Lid Safety Switch		KS-5100-1342	Y
	Ignitor Assembly, Includes 300 watt ceramic ignitor and ignitor tube assembly		KS-5030-1060	Y
	Ignitor Cartridge - 300 Watt		KS-5030-1061	Y
	Kit Hinge Pins STD Door		KS-5190-1601	Y
	Kit Switch Snap SE-L120		KS-5100-1340	Y
	Limit Switch, F125, Convection Fan		KS-5100-1320	Y
	Limit Switch, L250		KS-5100-1330	Y
	Lock Collar 5/8"		KS-5010-1021	Y
	Side Panel Insert	Right	KS-5250-1690	Y
		Left	KS-5250-1691	Y
	Thermostat Kit		KS-5120-1361	Y
	Vacuum Switch, Plastic		KS-5090-1300	Y
	Kit, Glass Gasket		KS-5060-1151	Y
	Kit Auger Motor	Post May 2013	KS-5010-1011	Y
Accessories				
	Fresh Air Kit - Basement - 10' x 2" Aluminum Duct & Hood		KS-5150-1460	Y
	Fresh Air Kit- M/F - 3' x 2" Aluminum Duct		KS-5150-1450	Y
	Log Set		KS-5160-1470	Y



Service Parts

Pellet Stove
FPP2BD

FREE STANDING

Beginning Manufacturing Date: NA
Ending Manufacturing Date: Active



IMPORTANT: THIS IS DATED INFORMATION. When requesting service or replacement parts for your appliance please provide model number and serial number. All parts listed in this manual must be ordered from a dealer.



Stocked at Depot

ITEM	DESCRIPTION	COMMENTS	PART NUMBER	
	Acutron 4 Control Board		KS-5040-1101	Y
	Auger Shaft Assembly		KS-5010-1020	Y
	Acutron Wire Harness, 9 Pin Main Assembly		KS-5110-1350	Y
	Auger Bushings		KS-5010-1030	Y
	Easy Clean Grate Top		KS-5080-1270	Y
	Easy Clean Grate Bottom		KS-5080-1260	Y
	Combustion Fan w/Gasket		KS-5020-1040	Y
	Gasket , Combustion, 1/8" Fiber Glass Paper		KS-5060-1170	Y

Additional Service parts on following page

2/15



Service Parts

FREE STANDING

Beginning Manufacturing Date: NA
Ending Manufacturing Date: Active

IMPORTANT: THIS IS DATED INFORMATION. When requesting service or replacement parts for your appliance please provide model number and serial number. All parts listed in this manual must be ordered from a dealer.



Stocked at Depot

ITEM	DESCRIPTION	COMMENTS	PART NUMBER	
	Convection Fan Assembly w/Gasket	Pre Sept 2013	KS-5020-1050	Y
		Post Sept 2013	KS-5020-1052	Y
	Gasket , Convection Fan, 1/8" Fiber Glass Paper		KS-5060-1180	Y
	Fire Brick Holder		KS-5050-1140	Y
	Exhaust Manifold w/Gasket, 2 pieces		KS-5210-1652	Y
	Feed Shaft & Motor	Post May 2013	KS-5010-1031	Y
	Gasket, Ash Door		KS-5060-1200	Y
	Gasket, EZ Connect, 1/8" Fiber Glass Paper		KS-5060-1190	Y
	Kit,Ceramic Glass,8.25 x 12		KS-5070-1210	Y
	Kit Gasket Glass		KS-5060-1150	Y
	Kit Handle Assembly, Threaded		KS-5140-1448	Y
	Handle Latch		KS-5140-1446	Y
	Handle, Black Phenolic		KS-5140-1442	Y
	Hopper Lid Safety Switch		KS-5100-1342	Y
	Ignitor Assembly, Includes 300 watt ceramic ignitor and ignitor tube assembly		KS-5030-1060	Y
	Ignitor Cartridge - 300 Watt		KS-5030-1061	Y
	Kit CPT Door Assembly		KS-5190-1611	Y
	Kit Hinge Pins STD Door		KS-5190-1601	Y
	Kit Switch Snap SE-L120		KS-5100-1340	Y
	Limit Switch, F125, Convection Fan		KS-5100-1320	Y
	Limit Switch, L250		KS-5100-1330	Y
	Lock Collar 5/8"		KS-5010-1021	Y
	Thermostat Kit		KS-5120-1361	Y
	Vacuum Switch, Plastic		KS-5090-1300	Y
	Kit Auger Motor	Post May 2013	KS-5010-1011	Y
	Kit Fresh Air Intake 10'		KS-5150-1460	Y
	Kit Fresh Air Intake 3"		KS-5150-1450	Y
	Kit Stainless Steel Log Set		KS-5160-1470	Y
Accessories				
	Fresh Air Kit - Basement - 10' x 2" Aluminum Duct & Hood		KS-5150-1460	Y
	Fresh Air Kit- M/F - 3' x 2" Aluminum Duct		KS-5150-1450	Y
	Log Set		KS-5160-1470	Y



IMPORTANT: THIS IS DATED INFORMATION. When requesting service or replacement parts for your appliance please provide model number and serial number. All parts listed in this manual must be ordered from a dealer.



**Stocked
at Depot**

ITEM	DESCRIPTION	COMMENTS	PART NUMBER	
	Acutron 4 Control Board		KS-5040-1101	Y
	Auger Shaft Assembly		KS-5010-1020	Y
	Acutron Wire Harness, 9 Pin Main Assembly		KS-5110-1350	Y
	Auger Bushings		KS-5010-1030	Y

Additional service parts on following page

2/15



IMPORTANT: THIS IS DATED INFORMATION. When requesting service or replacement parts for your appliance please provide model number and serial number. All parts listed in this manual must be ordered from a dealer.



Stocked at Depot

ITEM	DESCRIPTION	COMMENTS	PART NUMBER	Stocked at Depot
	Burn Grate		KS-5080-1240	Y
	Combustion Fan w/Gasket		KS-5020-1040	Y
	Gasket , Combustion, 1/8" Fiber Glass Paper		KS-5060-1170	Y
	Convection Fan Assembly w/Gasket	Pre Sept 2013	KS-5020-1050	Y
		Post Sept 2013	KS-5020-1052	Y
	Gasket , Convection Fan, 1/8" Fiber Glass Paper		KS-5060-1180	Y
	Drop Chute/Firewall Cover		KS-5300-1740	Y
	Exhaust Manifold w/Gasket, 2 pieces		KS-5210-1652	Y
	Feed Shaft & Motor	Post May 2013	KS-5010-1031	Y
	Gasket, Ash Door		KS-5060-1200	Y
	Gasket, Door, 5/8" x 60"		KS-5060-1160	Y
	Gasket, EZ Connect, 1/8" Fiber Glass Paper		KS-5060-1190	Y
	Glass, Ceramic 8.25 X 12		KS-5070-1210	Y
	Gasket, Glass		KS-5060-1150	Y
	Handle Assembly		KS-5140-1448	Y
	Handle Latch		KS-5140-1446	Y
	Handle, Black Phenolic		KS-5140-1442	Y
	Hopper Lid Safety Switch		KS-5100-1342	Y
	Ignitor Assembly, Includes 300 watt ceramic ignitor and ignitor tube assembly		KS-5030-1070	Y
	Ignitor Cartridge - 300 Watt		KS-5030-1061	Y
	Kit-CPT Door Assembly		KS-5190-1611	Y
	Kit Hinge Pins STD Door		KS-5190-1601	Y
	Kit Switch Snap SE-L120		KS-5100-1340	Y
	Limit Switch, F125, Convection Fan		KS-5100-1320	Y
	Limit Switch, L250		KS-5100-1330	Y
	Lock Collar 5/8"		KS-5010-1021	Y
	Thermostat Kit		KS-5120-1361	Y
	Vacuum Switch, Plastic		KS-5090-1300	Y
	Kit Auger Motor	Post May 2013	KS-5010-1011	Y
Accessories				
	Fresh Air Kit - Basement - 10' x 2" Aluminum Duct & Hood		KS-5150-1460	Y
	Fresh Air Kit- M/F - 3' x 2" Aluminum Duct		KS-5150-1450	Y
	Log Set		KS-5160-1470	Y



Service Parts

HPP32BD
Pellet Stove

HOME HEATER 300

Beginning Manufacturing Date: Sept 2012
Ending Manufacturing Date: Active



Part number list on following page.

02/15



Service Parts

HOME HEATER 300

Beginning Manufacturing Date: Sept 2012
Ending Manufacturing Date: Active

IMPORTANT: THIS IS DATED INFORMATION. When requesting service or replacement parts for your appliance please provide model number and serial number. All parts listed in this manual must be ordered from a dealer.



**Stocked
at Depot**

ITEM	DESCRIPTION	COMMENTS	PART NUMBER	
	Acutron 4 Control Board		KS-5040-1101	Y
	Auger Shaft Assembly		KS-5010-1020	Y
	Acutron Wire Harness, 9 Pin Main Assembly		KS-5110-1350	Y
	Auger Bushings		KS-5010-1030	Y
	Burn Grate		KS-5080-1240	Y
	Combustion Fan w/Gasket		KS-5020-1040	Y
	Gasket , Combustion, 1/8" Fiber Glass Paper		KS-5060-1170	Y
	Convection Fan Assembly w/Gasket	Pre Sept 2013	KS-5020-1050	Y
		Post Sept 2013	KS-5020-1052	Y
	Gasket , Convection Fan, 1/8" Fiber Glass Paper		KS-5060-1180	Y
	Drop Chute/Firewall Cover		KS-5300-1740	Y
	Exhaust Manifold w/Gasket, 2 pieces		KS-5210-1652	Y
	Feed Shaft & Motor	Post May 2013	KS-5010-1031	Y
	Gasket, Ash Door		KS-5060-1200	Y
	Gasket, Door, 5/8" x 60"		KS-5060-1160	Y
	Gasket, EZ Connect, 1/8" Fiber Glass Paper		KS-5060-1190	Y
	Glass, Ceramic 8.25 X 12		KS-5070-1210	Y
	Gasket, Glass		KS-5060-1150	Y
	Handle Assembly		KS-5140-1448	Y
	Handle Latch		KS-5140-1446	Y
	Handle, Black Phenolic		KS-5140-1442	Y
	Hopper Lid Safety Switch		KS-5100-1342	Y
	Ignitor Assembly, Includes 300 watt ceramic ignitor and ignitor tube assembly		KS-5030-1070	Y
	Ignitor Cartridge - 300 Watt		KS-5030-1061	Y
	Kit Switch Snap SE-L120		KS-5100-1340	Y
	Limit Switch, F125, Convection Fan		KS-5100-1320	Y
	Limit Switch, L250		KS-5100-1330	Y
	Lock Collar 5/8"		KS-5010-1021	Y
	Thermostat Kit		KS-5120-1361	Y
	Vacuum Switch, Plastic		KS-5090-1300	Y
	Kit Auger Motor	Post May 2013	KS-5010-1011	Y
Accessories				
	Fresh Air Kit - Basement - 10' x 2" Aluminum Duct & Hood		KS-5150-1460	Y
	Fresh Air Kit- M/F - 3' x 2" Aluminum Duct		KS-5150-1450	Y
	Log Set		KS-5160-1470	Y



Service Parts

STEP TOP

Pellet Stove
 FPPST4BD

Beginning Manufacturing Date: NA
 Ending Manufacturing Date: Active



IMPORTANT: THIS IS DATED INFORMATION. When requesting service or replacement parts for your appliance please provide model number and serial number. All parts listed in this manual must be ordered from a dealer.



Stocked at Depot

ITEM	DESCRIPTION	COMMENTS	PART NUMBER	
	Acutron 4 Control Board		KS-5040-1101	Y
	Auger Shaft Assembly		KS-5010-1020	Y
	Acutron Wire Harness, 9 Pin Main Assembly		KS-5110-1350	Y
	Auger Bushings		KS-5010-1030	Y

Additional service parts on following page.

2/15



Service Parts

STEP TOP

Beginning Manufacturing Date: NA
Ending Manufacturing Date: Active

IMPORTANT: THIS IS DATED INFORMATION. When requesting service or replacement parts for your appliance please provide model number and serial number. All parts listed in this manual must be ordered from a dealer.



**Stocked
at Depot**

ITEM	DESCRIPTION	COMMENTS	PART NUMBER	
	Grate, Burn	Post May 2013	KS-5080-1256	Y
	Grate, Easy Clean Bottom	Pre May 2013	KS-5080-1260	Y
	Grate, Easy Clean Top w/Open Bottom	Pre May 2013	KS-5080-1270	Y
	Combustion Fan w/Gasket		KS-5020-1040	Y
	Gasket , Combustion, 1/8" Fiber Glass Paper		KS-5060-1170	Y
	Convection Fan Assembly w/Gasket	Pre Sept 2013	KS-5020-1050	Y
		Post Sept 2013	KS-5020-1052	Y
	Gasket , Convection Fan, 1/8" Fiber Glass Paper		KS-5060-1180	Y
	DHC Control Replacement		KS-5040-1091	Y
	Fire Brick Holder		KS-5050-1140	Y
	Exhaust Manifold w/Gasket, 2 pieces		KS-5210-1652	Y
	EZ Clean Rod		KS-5080-1271	Y
	EZ Clean Spring Handle		KS-5080-1272	Y
	Feed Shaft & Motor	Post May 2013	KS-5010-1031	Y
	Gasket, Ash Door		KS-5060-1200	Y
	Gasket, Door, 5/8" x 60"		KS-5060-1160	Y
	Gasket, EZ Connect, 1/8" Fiber Glass Paper		KS-5060-1190	Y
	Glass, Ceramic 8.25 X 12		KS-5070-1210	Y
	Gasket, Glass		KS-5060-1150	Y
	Handle Assembly		KS-5140-1448	Y
	Handle Latch		KS-5140-1446	Y
	Handle, Black Phenolic		KS-5140-1442	Y
	Hopper Lid Safety Switch		KS-5100-1342	Y
	Ignitor Assembly, Includes 300 watt ceramic ignitor and ignitor tube assembly		KS-5030-1060	Y
	Ignitor Cartridge - 300 Watt		KS-5030-1061	Y
	Kit Hinge Pins STD Door		KS-5190-1601	Y
	Kit Switch Snap SE-L120		KS-5100-1340	Y
	Limit Switch, F125, Convection Fan		KS-5100-1320	Y
	Limit Switch, L250		KS-5100-1330	Y
	Lock Collar 5/8"		KS-5010-1021	Y
	Thermostat Kit		KS-5120-1361	Y
	Vacuum Switch, Plastic		KS-5090-1300	Y
	Kit Auger Motor	Post May 2013	KS-5010-1011	Y
Accessories				
	Fresh Air Kit - Basement - 10' x 2" Aluminum Duct & Hood		KS-5150-1460	Y
	Fresh Air Kit- M/F - 3' x 2" Aluminum Duct		KS-5150-1450	Y
	Log Set		KS-5160-1470	Y

PART LOCATIONS FOR ACUTRON 4 STOVES

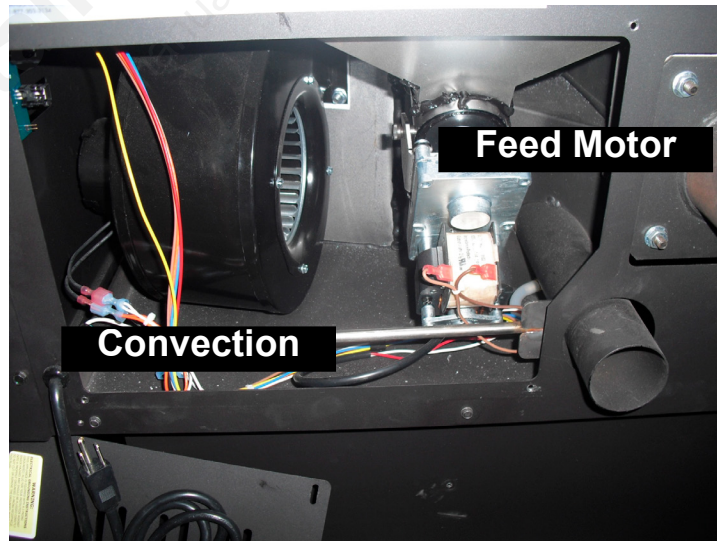
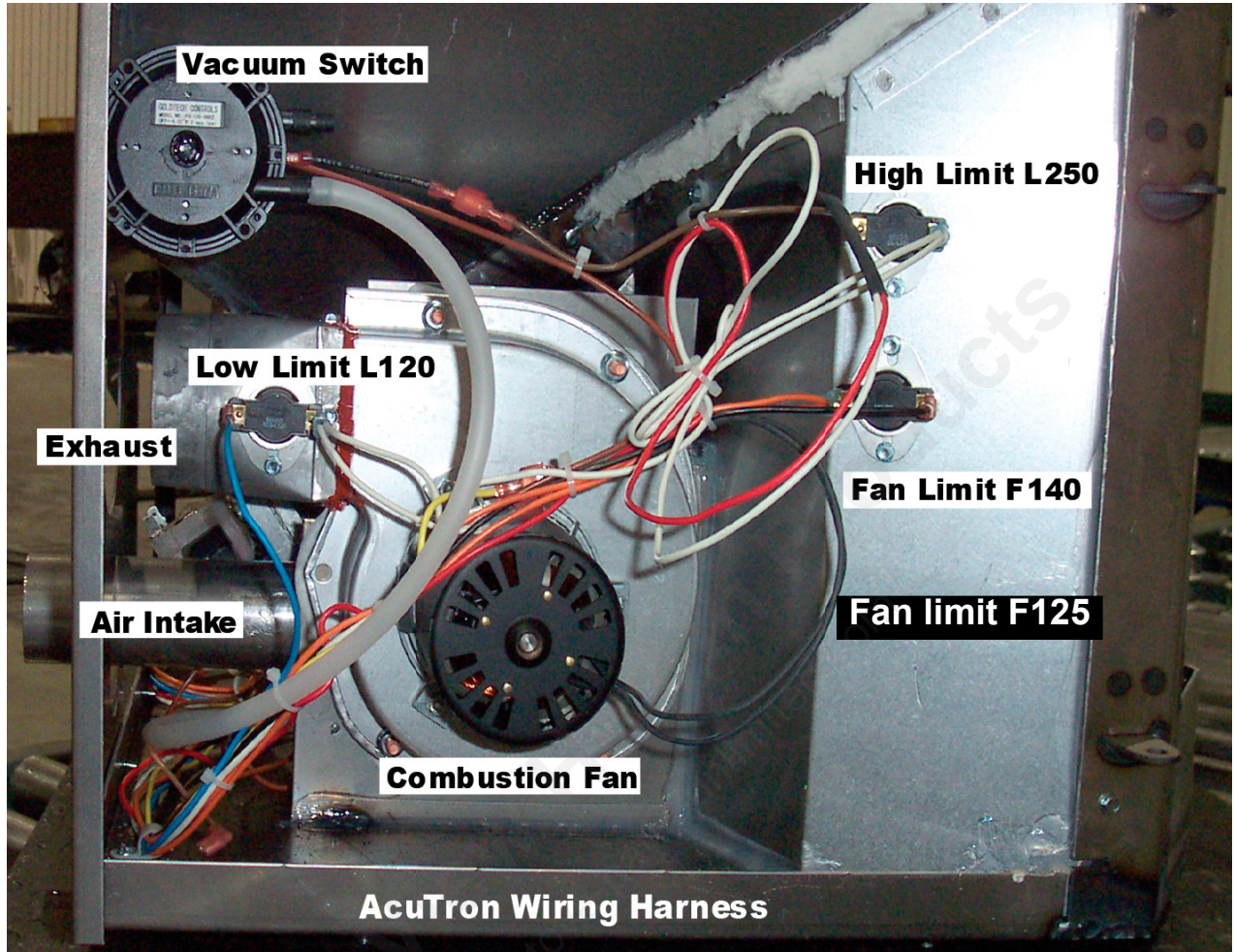

ACUTRON 4 OPERATION CHART

1. CHOOSE MODE OF OPERATION BY HOLDING THE "OFF" BUTTON.
 (MANUAL= 1 & 4)
 (T-STAT ON/OFF= 1 & 2)
 (T-STAT LOW/HIGH= 3 & 4)

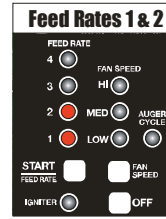
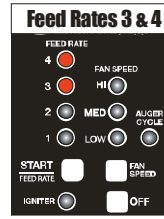

2. PUSH START BUTTON LOCK IN THE MODE.



3. PRESS START BUTTON OR TURN ON THE THERMOSTAT TO BEGIN THE CYCLE.



4. EXHAUST BLOWER COMES ON



5. VACUUM SWITCH CLOSSES

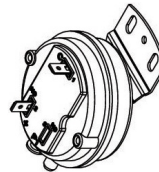

6. FEED MOTOR COMES ON AND FEEDS FUEL INTO THE FIREPOT.



7. AUGER CYCLE LIGHT COMES ON.

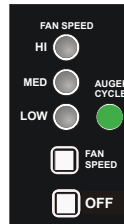

ACUTRON 4 OPERATION CHART

8. RED FEED RATE LIGHT WILL FLASH RAPIDLY

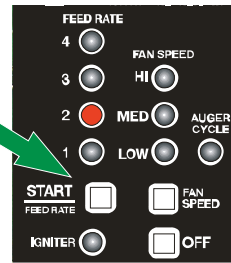

9. IGNITER COMES ON



10. RED IGNITER LIGHT WILL COME ON.

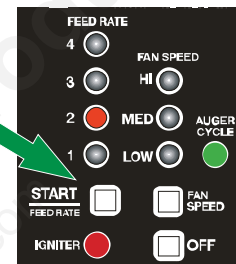

11. FIRE LIGHTS AND HAS 15 MINS TO REACH 120 DEGREES OR IT WILL SHUT DOWN.



12. FIRE REACHES 120 DEGREES AND PROOF OF FIRE SNAP DISC OPENS. (L120)

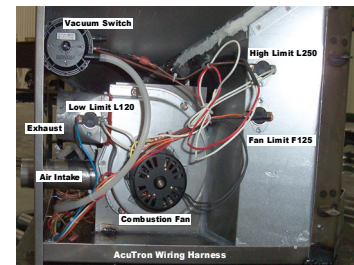

13. 5 MIN SAFETY DELAY BURN MODE STARTS AND RED LIGHT WILL FLASH SLOWER.

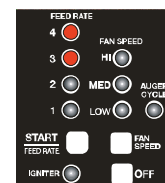

ACUTRON 4 OPERATION CHART



14. IGNITER AND IGNITER LIGHT WILL SHUT OFF.

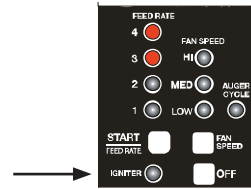

15. IF THE F125 CONVECTION FAN SNAP DISC SEES 125 DEGREES OR HIGHER, IT WILL KICK THE BLOWER UP TO HIGH UNTIL IT COOLS DOWN.



16. RED FEED RATE LIGHT WILL STOP FLASHING AND GO SOLID.

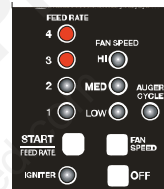

17. ROOM REACHES TEMPERATURE OR HEAT IS NO LONGER NEEDED. THERMOSTAT TURNS OFF OR "OFF" BUTTON IS PUSHED.



18. GREEN FAN SPEED LIGHTS WILL FLASH RAPIDLY AND GO INTO A 30 MIN SHUTDOWN.

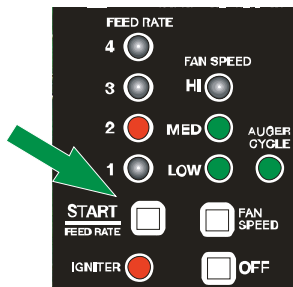

19. AFTER SHUT DOWN IS COMPLETE, ALL BLOWERS WILL BE OFF.

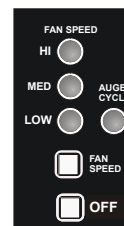

**TROUBLESHOOTING FLOW CHART
ACUTRON 4 PELLET STOVES**

Symptoms

T/S Chart

Convection Blower Not Coming On	Page 21
Stove Will Not Shut Off	Page 22
Lazy or Sooty Flames	Page 23
Appliance Will Not Start	Page 24
Stove Keeps Going Out	Page 25
Smoke Smell or Smoke Spillage	Page 26
No Heat Output	Page 27
Not Lighting the Fuel	Page 28
Exhaust Blower Not Coming On	Page 29
Not Feeding Pellets	Page 30
No Power	Page 31

REFER TO THE OWNERS MANUAL FOR INFORMATION ON MAKING ADJUSTMENTS TO THE APPLIANCE OR FOR THE PROCEDURES FOR REPLACING PARTS.

WARNING!

ALWAYS UNPLUG THE STOVE BEFORE CLEANING, REPLACING COMPONENTS AND CHECKING WIRE CONNECTIONS.

ACUTRON 4 APPLIANCES

CONVECTION BLOWER TROUBLESHOOTING

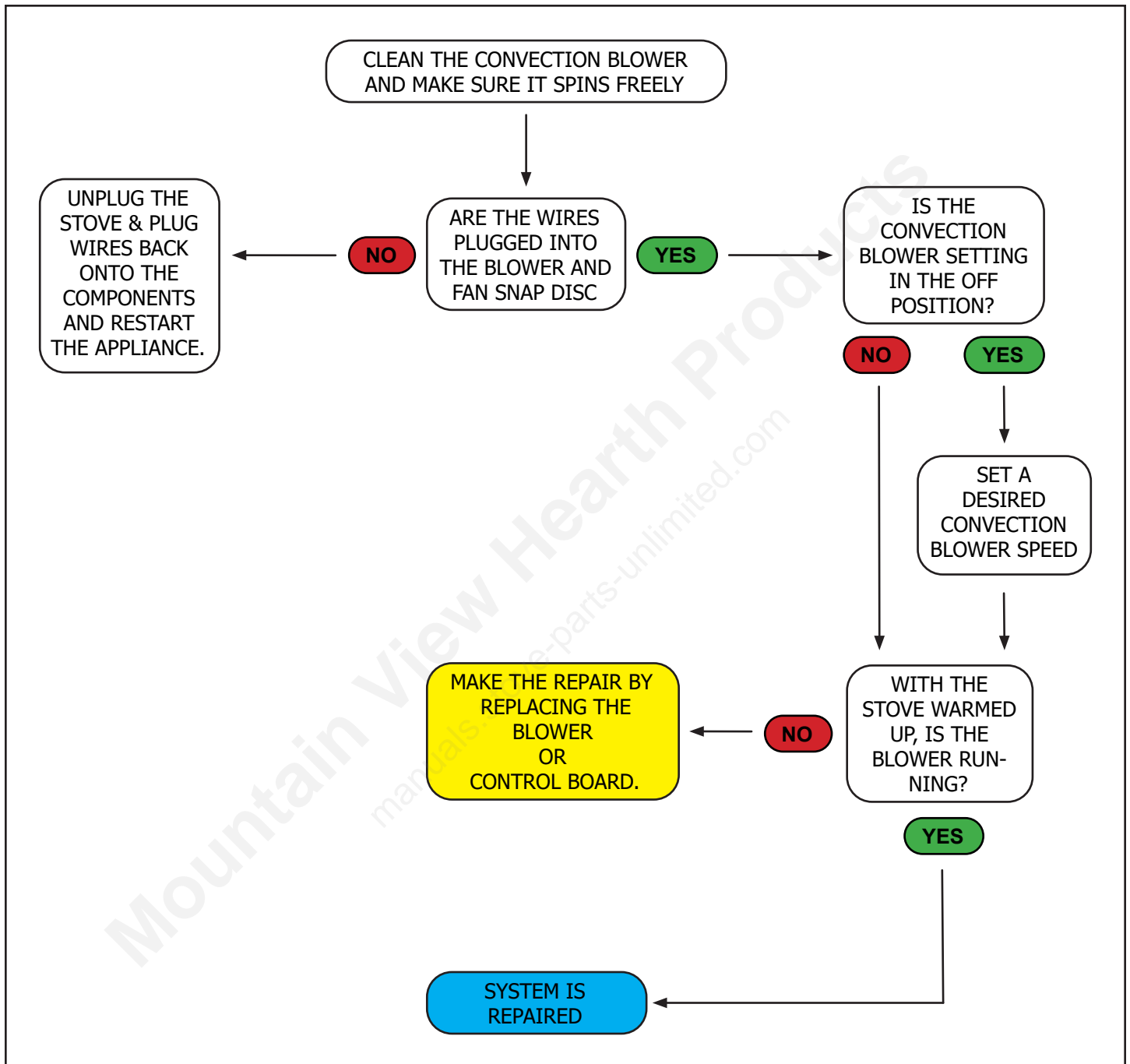

ACUTRON 4 APPLIANCES
STOVE WILL NOT SHUT OFF

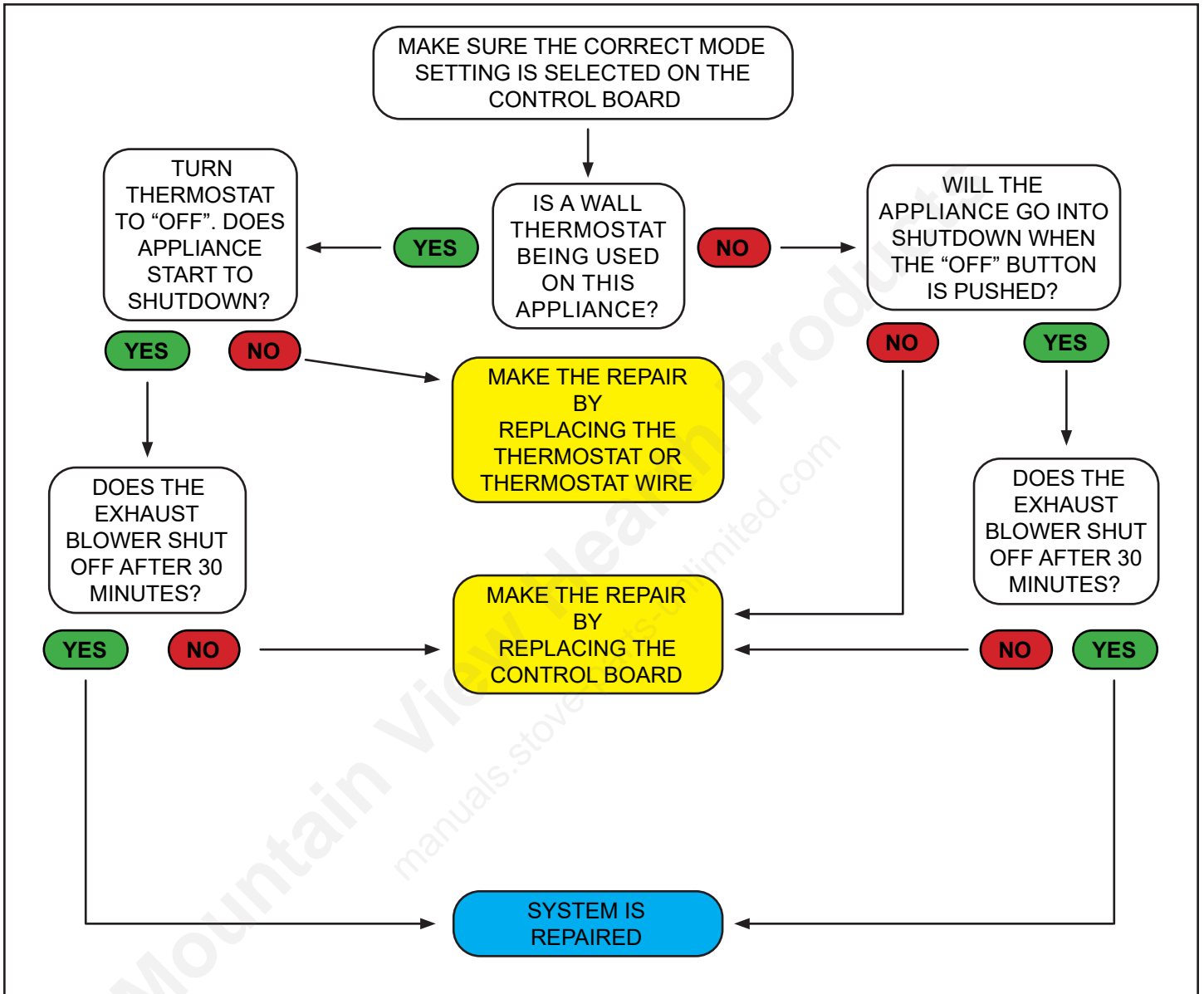

ACUTRON 4 APPLIANCES

LAZY SOOTY FLAMES OR FUEL BUILDING UP IN THE BURN GRATE

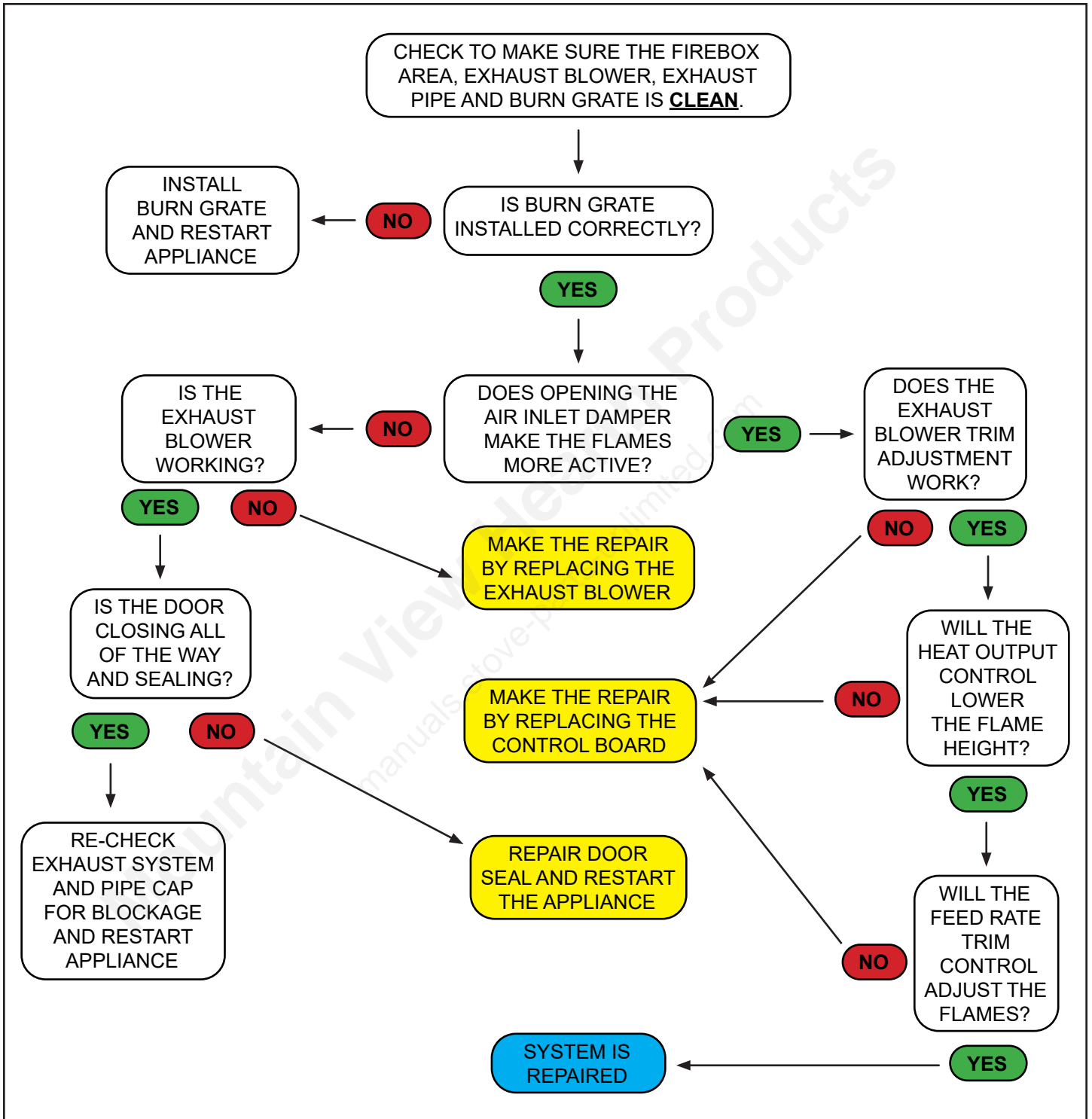

ACUTRON 4 APPLIANCES

STOVE KEEPS GOING OUT

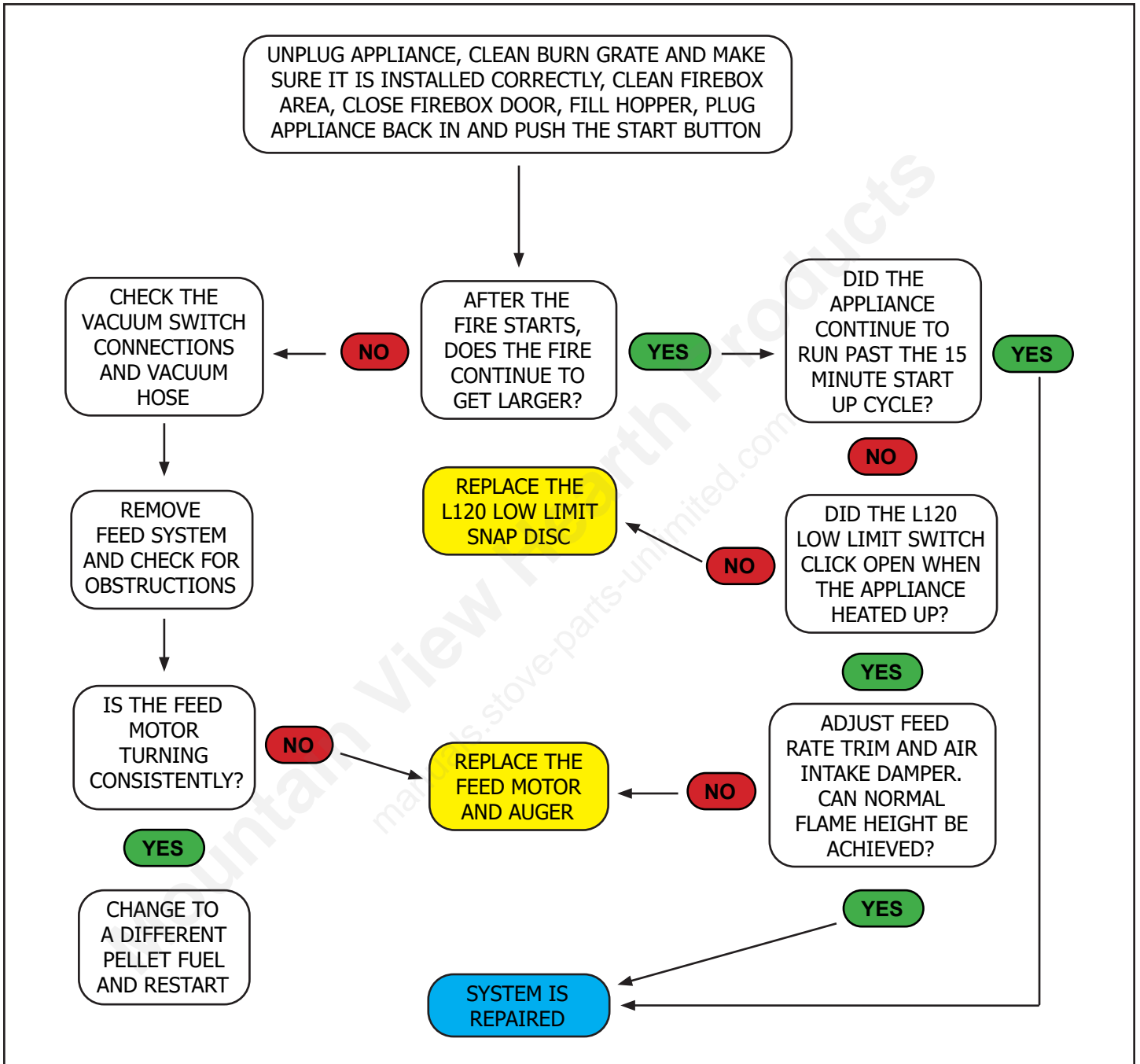

ACUTRON 4 APPLIANCES
SMOKE SMELL OR SMOKE SPILLAGE

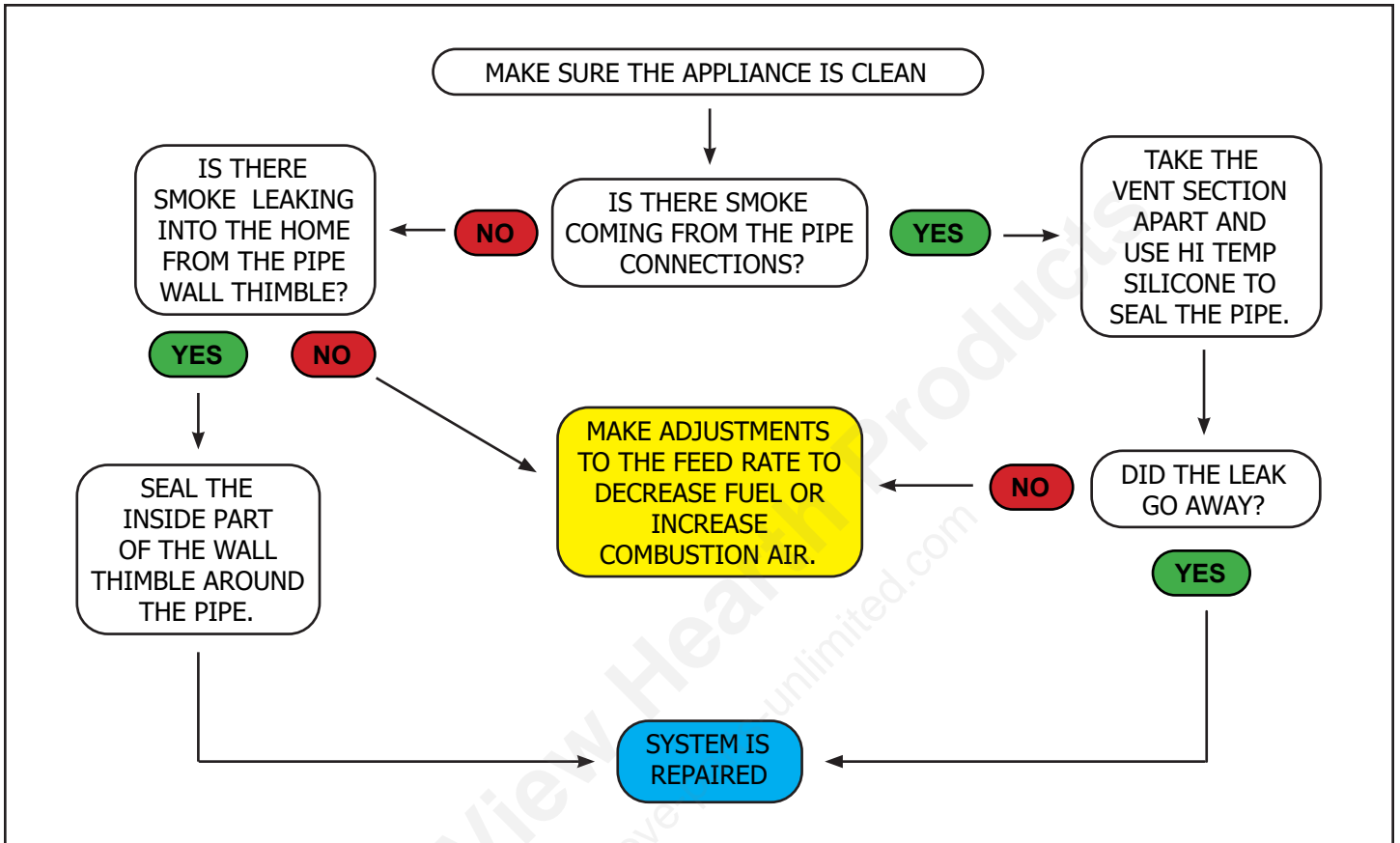

ACUTRON 4 APPLIANCES

NO HEAT OUTPUT

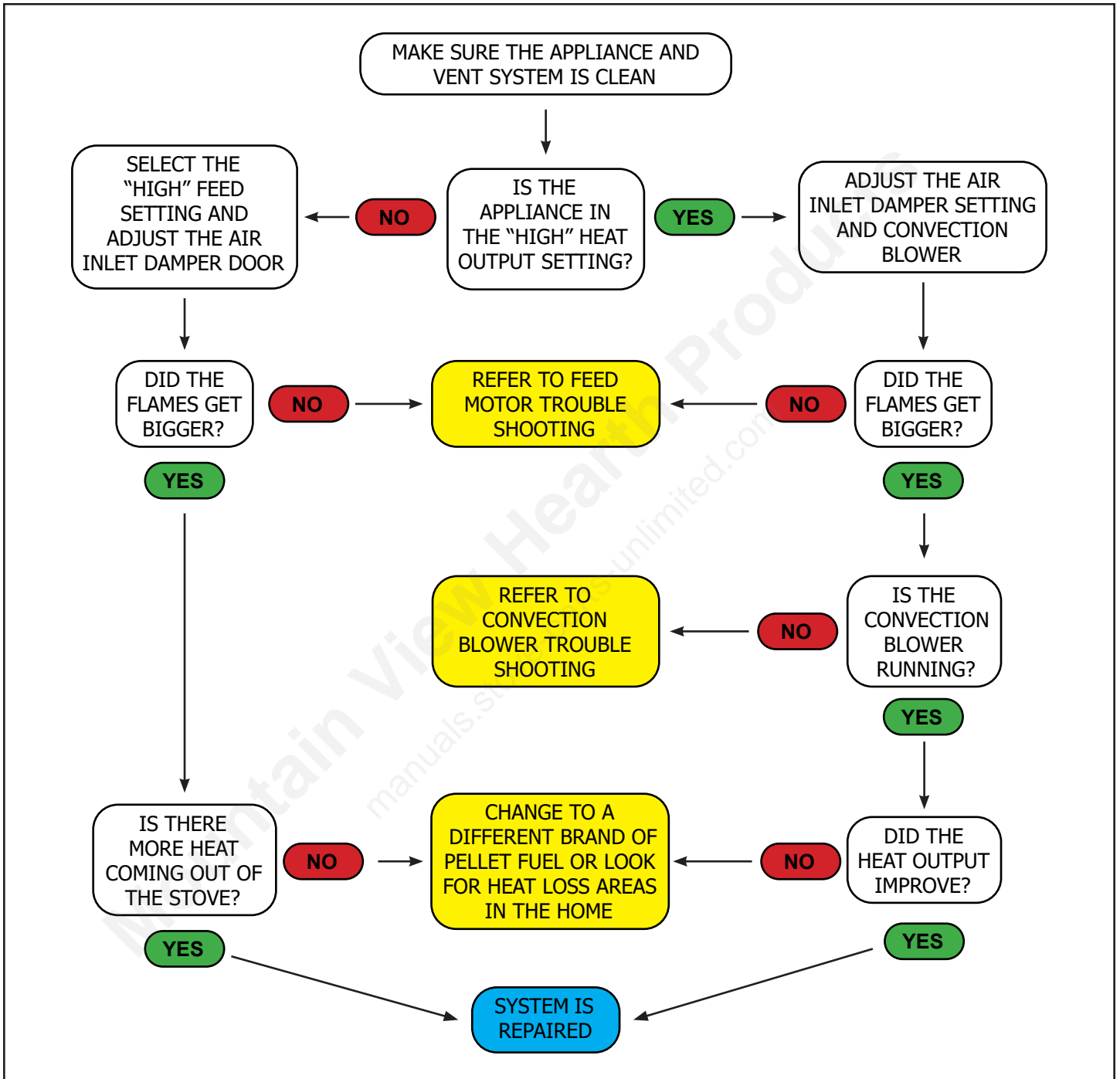

ACUTRON 4 APPLIANCES

NOT LIGHTING THE FUEL

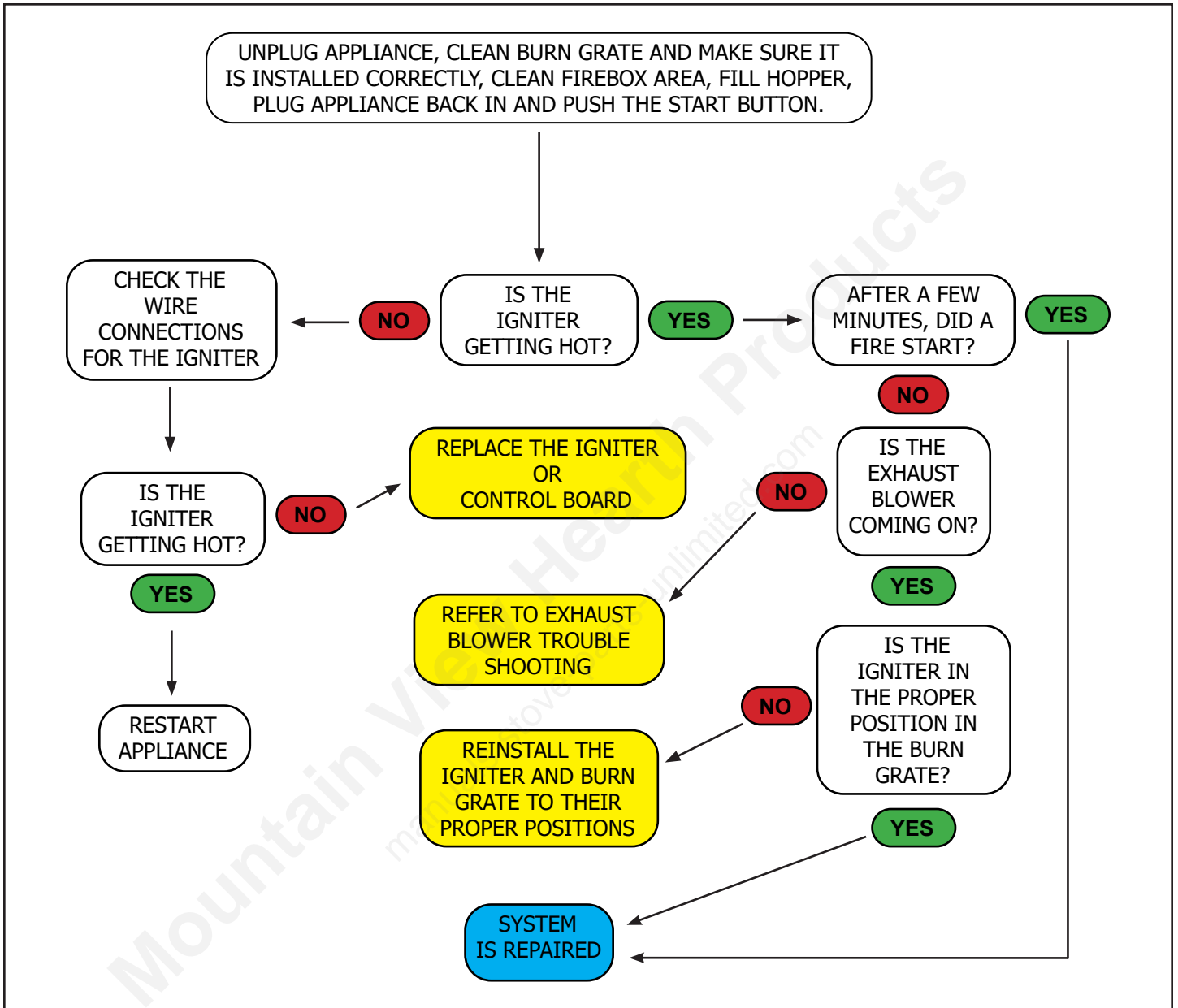

ACUTRON 4 APPLIANCES
EXHAUST BLOWER NOT COMING ON

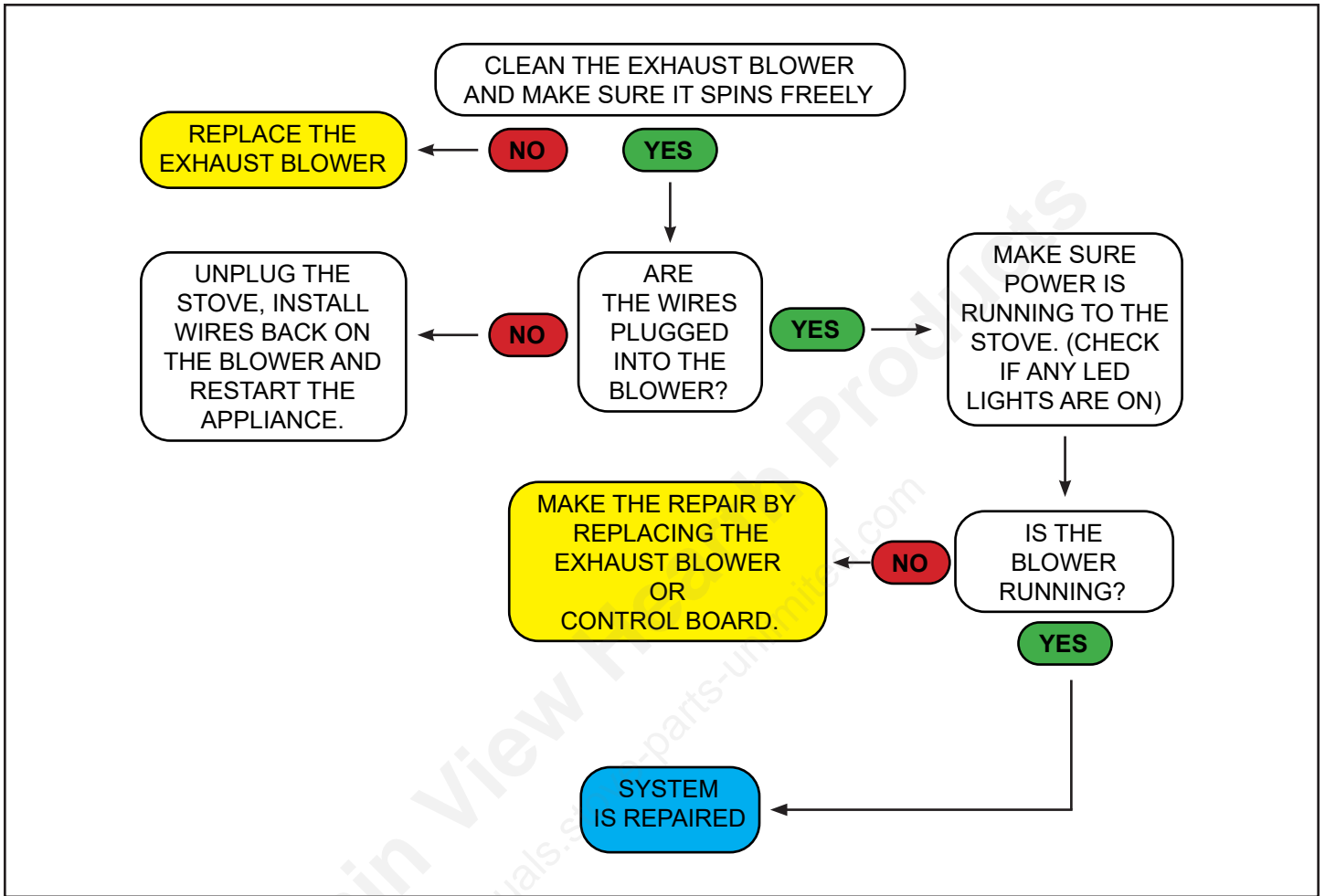

ACUTRON 4 APPLIANCES NOT FEEDING PELLETS

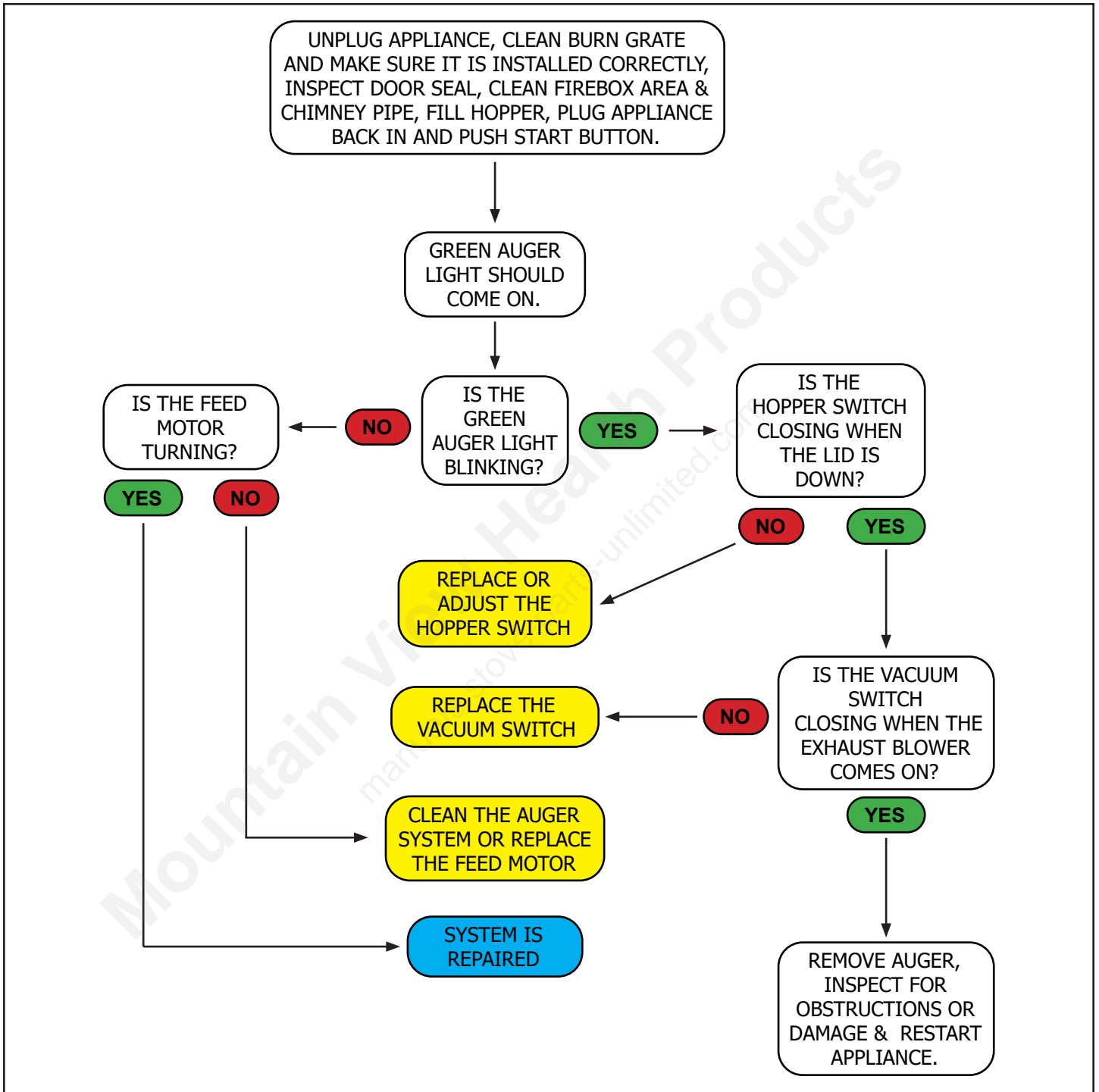

ACUTRON 4 APPLIANCES

NO POWER

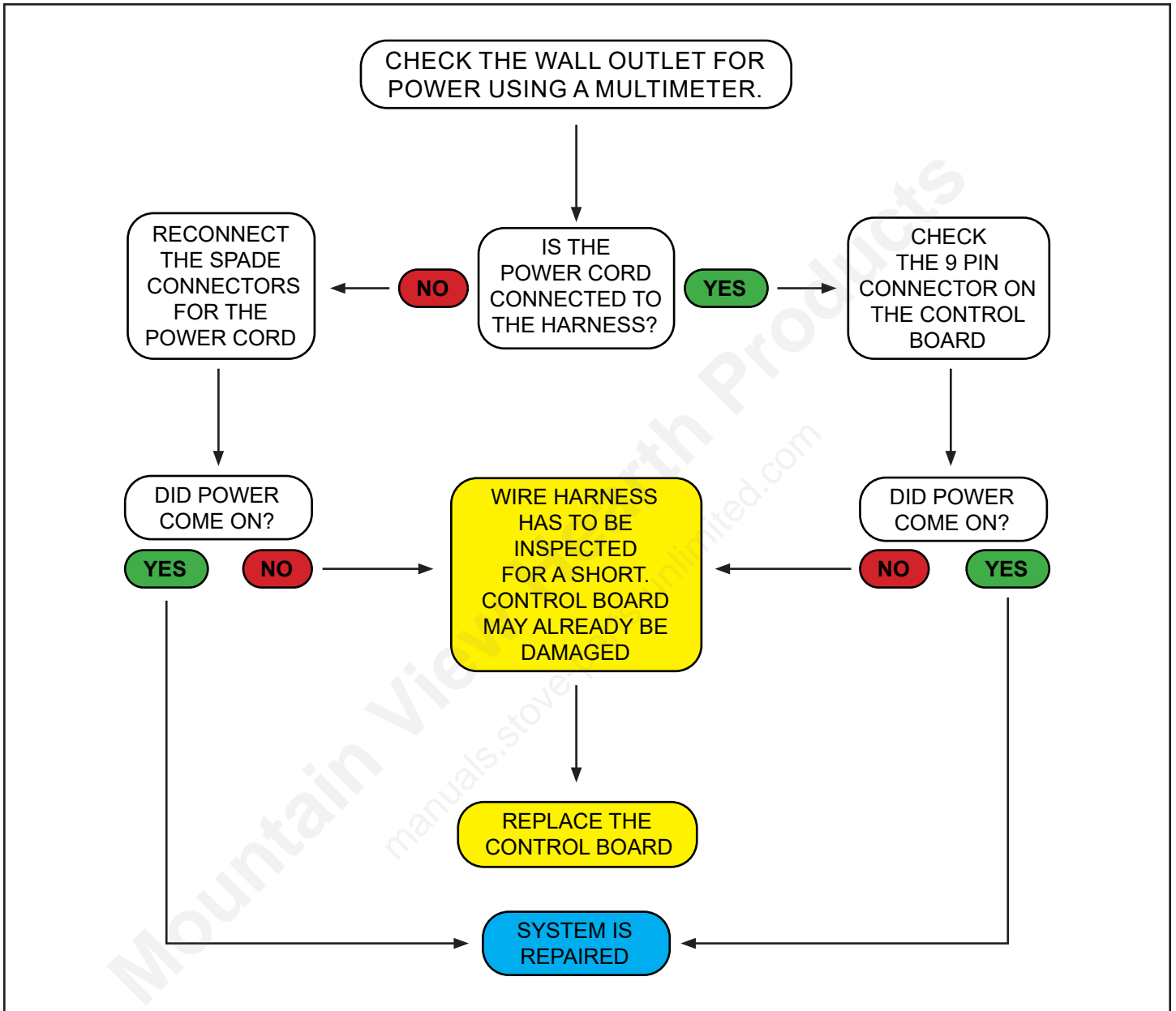

ACUTRON 4 APPLIANCES
REPAIR PROCEDURE TABLE OF CONTENTS

<u>Section</u>	<u>Page</u>
Wire Harness	Page 33
Auger Motor Assembly	Page 35
Combustion Fan	Page 37
Convection Fan	Page 39
Igniter	Page 40
Control Board	Page 41
Vacuum Switch	Page 43
Hopper Lid Switch	Page 44
Snap Disc Locations	Page 45
Auger Shaft ONLY	Page 47
Firepot/Grate	Page 49
Snap Disc Replacement	Page 50
Feed Assembly (Newer Style)	Page 51
Door Handle Assembly	Page 52

Mountain View Hearth Products
manuals.stove-parts-unlimited.com



Main AcuTron Wire Harness Installation Instructions



Recommended Tools:

- 1/4" Hex Nut Driver
- Socket Driver
- Small Sized Flat Head Screwdriver

NOTE: Always Disconnect Power Before Performing Service Work

Step By Step Installation:

1. Unplug the stove power cord from the wall outlet (Fig. A).
2. Remove left, right, and rear access panel (Fig. B) from stove.
3. Unplug all connections from wire harness
4. Unscrew the wire retaining clamps from the floor of the stove and remove the wire harness.
5. Insert the new wire harness into wire retaining clamps and screw back into place.
6. Re-connect wire harness wires (see next page for connections).
7. Attach left, right and rear access panel to stove.

Fig A



Fig B



ACUTRON 4 REPAIR PROCEDURES

Main AcuTron Wire Harness

ACU-TRON WIRING HARNESS

Connection	Wire Color	Connection Type	Termination	Lead From
Igniter	Red White	White 2 Prong Male Plug	White Female Igniter Plug	Control Board Common
L250 Hi Limit Switch	White	Straight Female	Post	Common
	Brown	Straight Female	Post	Vacuum Switch
F140 Low Limit Switch	Black	Straight Female	Post	Sta-Clean Grate, Power cord
	Orange	Straight Female	Post	Convection fan
Vacuum Switch	Brown	Straight Female	Post	Auger Motor
	Brown	Straight Female	Post	Hi Limit Switch
Igniter Limit Switch (L120)	Blue	Straight Female	Post	Control Box
	White	Straight Female	Post	Common
Combustion Fan	Yellow	Straight Female	Fan Male Connector	Control Box
	White	Straight Male	Fan Female Connector	Common
Auger Motor	Tan	Straight Female	Post	Control Box
	Brown	Straight Female	Post	Vacuum Switch
Optional Sta-Clean Grate	Black	Straight Female	Male Connector	Power, Control Board, F140
	White	Straight Female	Male Connector	Common
Convection Fan	Orange	Straight Male	Fan Female Connector	F140
	White	Straight Female	Fan Male Connector	Common
Power Cord	White	Straight Male	Female Connector	Common
	Black	Straight Female	Male Connector	Control Board, Sta-clean Grate, F140

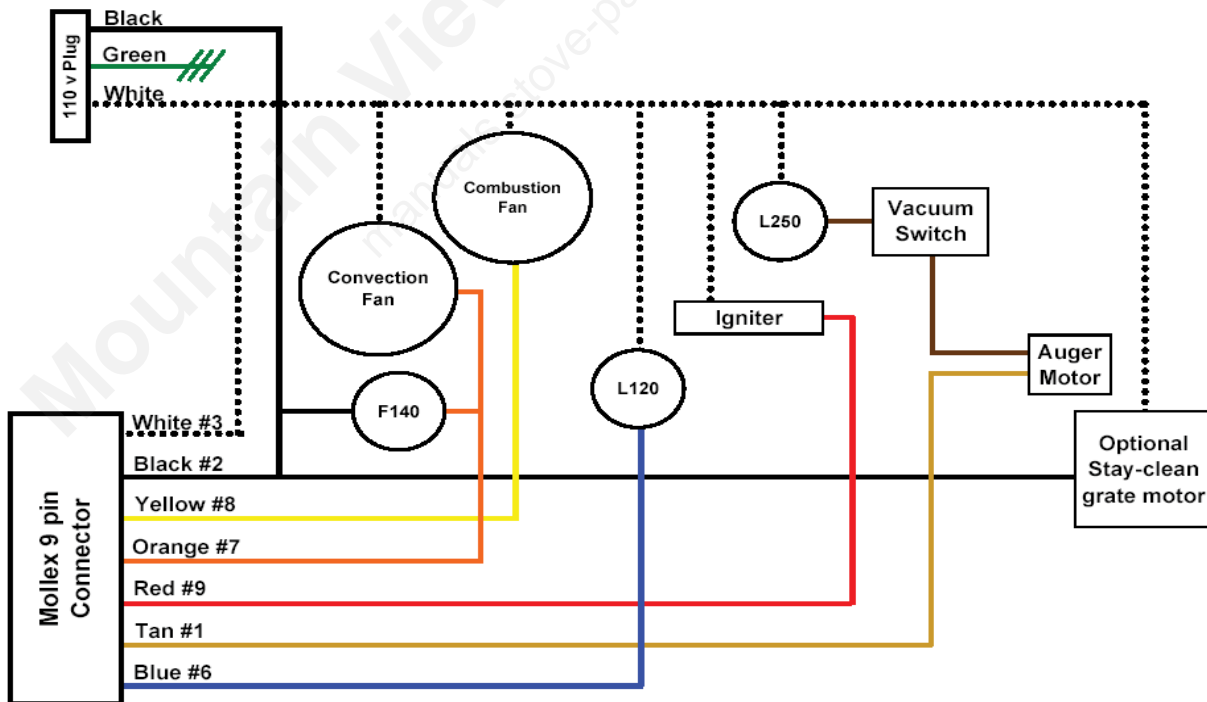

NOTE: Connector pin positions 4 and 5 are empty

Auger Motor Assembly Installation Instructions

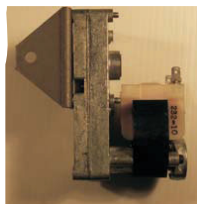

Parts Included

- Auger Motor Assembly
- Motor and Gear Box
- Mounting Bracket

Recommended Tools:

- 5/32" Allen Key
- Socket Driver
- Side Cutters or Knife
- 1/4" Hex Nut Driver
- RTV Silicone

NOTE: Always Disconnect Power Before Performing Service Work

Instructions:

1. Unplug the stove power cord from the wall outlet. Fig A
2. To gain access to the back of the appliance, remove the 1/4" hex screws from the four corners of the REAR SLOTTED ACCESS PANEL. This is located on the back lower side of the appliance. Fig B
3. To gain access to the side of the appliance, remove the 1/4" hex screws from the LEFT HAND SIDE PANEL. These are located on the back left hand side corner of the appliance. Fig B
4. Locate the position of the SET SCREW (F) located on the LOCK COLLAR (E). You will find it easier to service if the set screw is facing directly toward the combustion fan or left hand side panel. Fig D
5. You may have to plug the appliance back in, Press the Start button to activate the auger motor. When the set screw is facing directly toward the left hand side panel, unplug the stove to stop the auger cycle.
6. Disconnect the two wires from the auger motor.
7. Loosen the SET SCREW (F) on the lock collar.
8. Remove the SET SCREW (B) completely from the auger mounting bracket. This is found on the control board side of the auger, and secures the auger motor to the auger feed tube. Fig E
9. Gently slide the motor backwards and away from the auger shaft and tube.



Fig A



Fig B

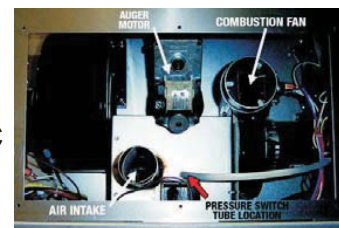

Fig C

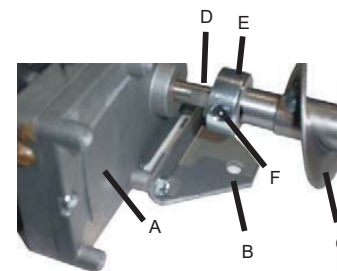

Fig D



Fig E

Technical Support
www.pelprostoves.com

7081-122C

HEARTH & HOME
technologies
The Hearth Expert

ACUTRON 4 REPAIR PROCEDURES

Auger Motor Assembly

Step By Step Installation:

1. Before installing the new auger motor, ensure that the flat spot on the auger motor shaft (D) is lined up in the same direction as the auger shaft set screw (F). Both should be facing directly toward the left hand side panel (G).
2. You may have to plug the motor in and start the control board to allow the auger motor shaft to turn in the direction you want.
3. Slide the new auger motor (A) onto the auger shaft (C).
4. Re-install the set screw on the mounting bracket first (B) hand tighten as much as possible, then use the 5/32 allen key to tighten firmly.
5. Firmly hand tighten the set screw found on the lock collar (F). Use the 5/32 allen key to tighten firmly.
6. Reconnect the two wires to the auger motor.
Note: If the connectors do not reach the motor, you may have to snip one or two wire ties located close to the connection ends.
7. Plug stove in and start the control board to confirm that everything is working correctly.
8. Re-install the rear access panel
9. Re-install the left hand side panel.
10. Slide stove back into place.
11. Re-install the Approved PL Venting or Stainless Liner to the exhaust outlet of the combustion fan. Make sure ALL joints and connections are sealed using only HIGH TEMP RTV Silicone.

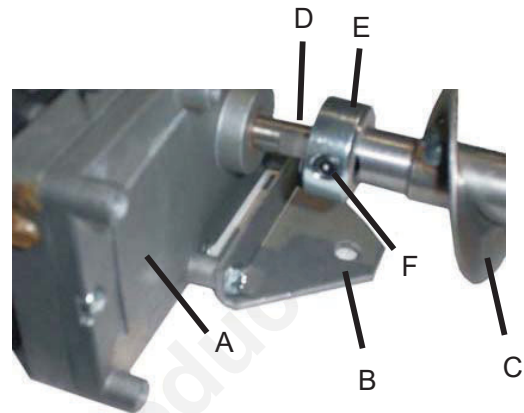

Final Step

Start -Up the appliance and go through the complete START UP procedure.

Combustion Fan Installation Instructions



Parts Included

- 1- Combustion Fan
- NO exhaust hook-up
- 1 - Combustion Fan Gasket

Recommended Tools:

- 7/16" Narrow Deep Socket
- Socket Driver
- Putty Knife or Scraper
- 1/4" Hex Nut Driver
- RTV Silicone
- Side Cutters or Knife

NOTE: Always Disconnect Power Before Performing Service Work

Step By Step Removal:

1. Unplug the stove power cord from your surge protected power source. (Fig A)
2. To gain access to the inside of the appliance, remove the 1/4" hex screws from the LEFT HAND SIDE PANEL. These are located on the back left hand side corner of the appliance. (Fig B)
3. Remove the 1/4" hex screw holding the wire harness clamp and the Green GROUND WIRE from the combustion fan. This is located on the base of the appliance and off to the left of the fan.
4. Carefully disconnect the Blue and Double White wires from the IGNITER/LOW Limit switch (L120) located on the combustion fan.. Be sure to hold firmly on both sides of each connection, then wiggle and pull free.
5. For ease of fan removal it may be necessary to disconnect the Brown and Double White wires from the HI Limit Switch (L250) and the Double Orange and Black wires from the FAN Limit Switch (F140). These switches are located on the back of the firewall. (Fig C)
6. For further ease of fan removal, you may find it necessary to disconnect the AIR TUBE from the Vacuum Switch.
7. Disconnect the Yellow and Double White wires from the Black Combustion Fan connections. You may have to use your side cutters to cut any wire clamps.
8. Remove the 4 x 7/16" nuts that attach the combustion fan to the exhaust mounting.
9. Remove the used 1/8" fiber gasket and ensure the mounting manifold is clean of debris.
10. Unscrew the 4 - 1/4" self-tapping hex screws holding the exhaust manifold to the combustion fan housing. You will have to cut the RTV Silicone securing the manifold to the fan housing as well.
11. The Igniter Limit (L120) can remain mounted to the exhaust manifold, but if found on the fan housing this will need to be removed. Unscrew the 2 - 1/4" self tapping screws.



Fig A

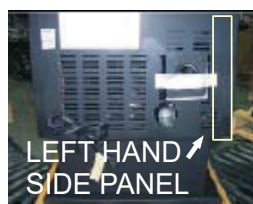

Fig B

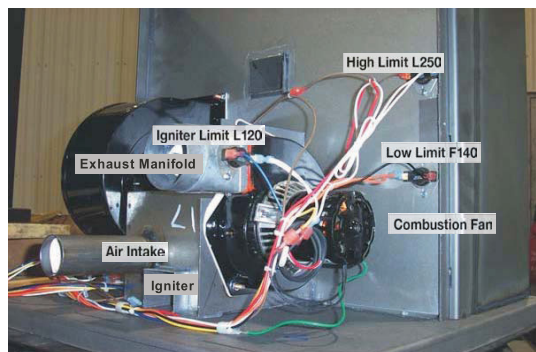
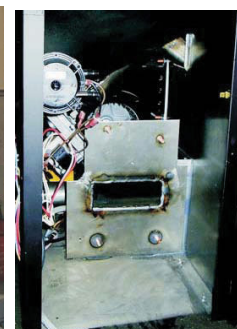

Fig C



Step By Step Installation:

1. Install the Exhaust Manifold, taken off the old fan housing, using the 4 - 1/4" self tapping screws and your 1/4" hex setter and driver. Use RTV silicone to seal around the manifold and around any screw holes. IT IS IMPORTANT TO ENSURE AN AIR TIGHT SEAL. See diagram below for location.
2. Install the Igniter/Low Limit (L120), if need to, using the 2 - 1/4" self tapping screws and your 1/4" hex setter and driver. Mount it directly on the fan housing. See diagram below. Be sure not to drill into the fan blade.
3. Install the new 1/8" fiber gasket on the exhaust manifold, over the mounting bolts.
4. Install the new Combustion Fan. Handtighten the 4-7/16" nuts to the mounting bracket. Be sure to mount fan to leave room for your socket to fit. Once tightened, ensure it is a snug fit with your socket.
5. Re-connect the Brown and Double White wires to the HIGH Limit switch (L250). It does not matter to which post.
6. Re-connect the Double Orange and Black wires to the FAN Limit switch (F140). Again it does not matter which post.
7. Re-connect the Blue and Double White wires to the IGNITER / LOW Limit Switch (L120).
8. Re-connect the Yellow and Double White wires to the Black wires from the combustion fan.
9. Re-connect the Green Ground wire to the base, using the 1/4" hex screw and harness clamp.
10. Re-connect the Vacuum Tube to the Vacuum switch. This should be hooked up to the plastic nipple marked "L".
11. Re-install the LEFT HAND PANEL.
12. Slide stove back into place.
13. Re-install the Approved PL Venting or Stainless Liner to the exhaust manifold of the combustion fan. Make sure ALL joints and connections are sealed using only HIGH TEMP RTV Silicone.



Style of exhaust manifold may not be exactly as shown

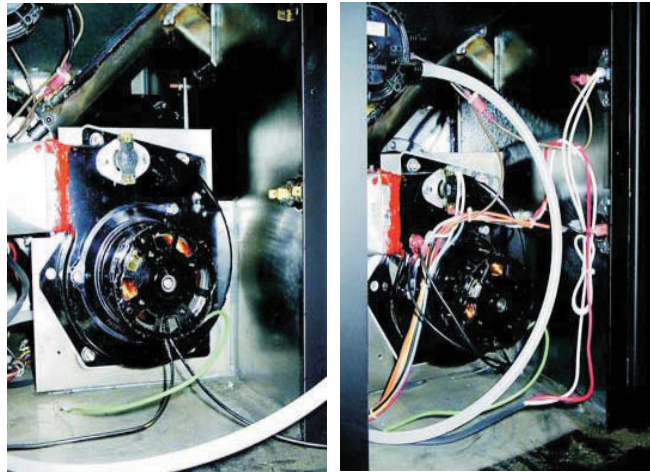

Convection Fan Installation Instructions

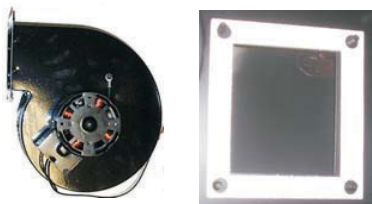

Parts Included

- 1- Convection Fan
- 1 - Convection Fan Gasket

Recommended Tools:

- 7/16" Narrow Deep Socket
- Socket Driver
- 1/4" Hex Nut Driver
- Putty Knife or Scraper

NOTE: Always Disconnect Power Before Performing Service Work

Step By Step Removal:

1. Unplug the stove power cord from the surge protected electrical source. Fig A.
Failure to do so could result in shorting out the control board.
2. To gain access to the Right Hand side of the appliance remove the 1/4" or 5/16" hex screws from the rear of the stove. There will be 3 or 4 depending on the model of stove. Slide loose panel straight back slightly, then lift off. Fig. B
3. Disconnect the Main Wire Harness from the Control Board.
4. Disconnect the Orange and double White wires from the convection fan.
5. Using your 7/16" nut driver, remove the 4 x 7/16" nuts securing the convection fan to the stove. Fig C.
6. Using your putty knife or scraper remove the gasket material. Fig D.

Fig A



Fig B



Fig C

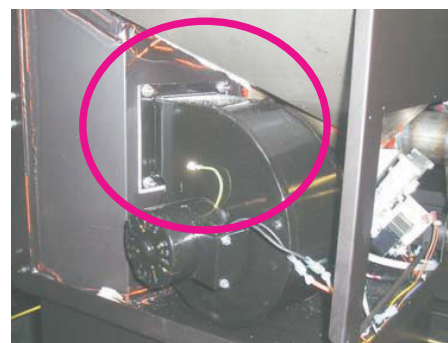
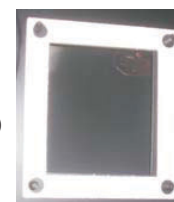

Fig D



Step By Step Re-Install:

1. Install the new gasketing
2. Place new Convection Fan over the threaded studs. Hand install and tighten the 4 x 7/16" nuts. Then tighten firmly, be careful not to over tighten, using the nut driver.
3. Re-connect the Fan wires to the Orange and Double White wires of the main harness. It does not matter which fan wire hooks to the main harness.
4. Re-install the Main Harness to the Control Board.
5. Re-install the Side Panel
6. Plug the appliance back into a surge protector, and start the Control Board to confirm that everything is working correctly.

300 Watt Igniter Cartridge

Installation Instructions



Parts Included

1- Igniter Cartridge

Recommended Tools:

- 1/8" Allen Wrench

NOTE: Always Disconnect Power Before Performing Service Work

Once you have removed the igniter assembly from the stove, follow these instructions to change the igniter cartridge. When the igniter cartridge has been changed follow the installation instructions to install the igniter assembly back into the stove.

Instructions:

1. Make note of the position of the igniter cartridge. Each igniter assembly has a different position for the igniter cartridge. Some stick out of the tube slightly and some are flush with the end of the tube.

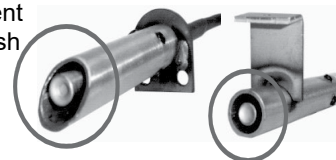

2. Slightly loosen 2 of the set screws that are next to each other with an Allen wrench. Do not loosen more than 1/4 of a turn.

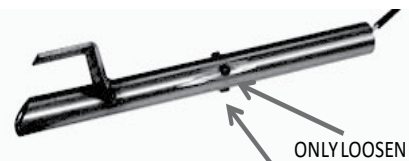
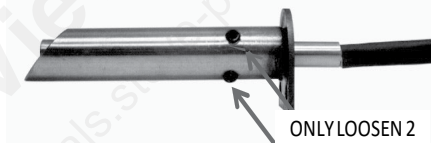

3. Slide the old igniter cartridge out of the tube.



4. Slide new igniter cartridge into the tube as far as the old one was in and then tighten the 2 set screws that you loosened in step 2. **DO NOT** over tighten the screws. Just tighten them enough so the cartridge cannot move. **IF THE SCREWS ARE OVERTIGHTENED, THE CERAMIC CARTRIDGE CAN CRACK. WARRANTY DOES NOT COVER DAMAGE DUE TO OVERTIGHTENED SET SCREWS.**

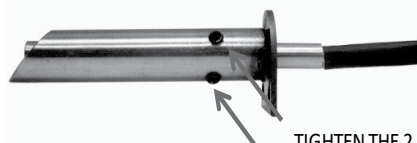

DO NOT OVERTIGHTEN

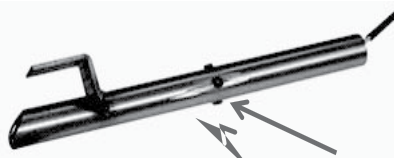

DO NOT OVERTIGHTEN

Acutron Control Installation Instructions



NOTE: Always Disconnect Power Before Performing Service Work

STEP 1: Unplug the stove.

STEP 2: Remove the rear access panel at the rear of the stove. There are four 1/4" hex head screws holding the panel in place.

STEP 3: Gently disconnect the white 9 pin molex connector from the control board.

STEP 4: Hold the control board with your hand from the back side while removing the screws via the side of the stove. Remove the two 1/4" hex head screws. Remove the control board through the rear access panel.

STEP 5: Place the new control board in the opening and replace the two 1/4" hex head screws.

STEP 6: Connect the 9 pin molex connector to the control board making sure the connection is tight.

STEP 7: Install the rear access panel with the four 1/4" hex head screws.

STEP 8: Plug the stove into power outlet and begin start up procedures.

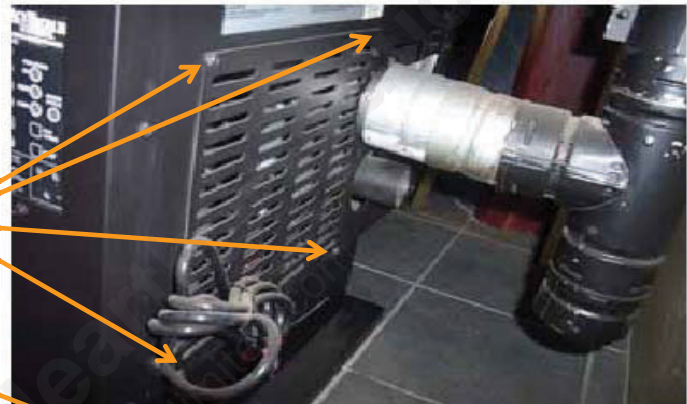

IMPORTANT: PLEASE READ BEFORE INSTALLING NEW CONTROL BOARD

The new controller for your stove has a memory feature. Should you have a power outage or blip, the appliance will come back on the setting that it was set to before.

This control is equipped with various functions. As a result, you need to check to make sure you are in the proper burn mode. Once your desired setting is reached, press the START button for operation.

To confirm the mode, press and hold in the OFF button. The feed rate lights will cycle as seen below. When the desired mode flashes release the OFF button and press start.

The 3 modes are as follows:

HIGH/LOW THERMOSTAT MODE - when off button is released after #3 and 4 lights flash

ON/OFF THERMOSTAT MODE - when off button is released after #1 and 2 lights flash

MANUAL MODE - when off button is released after #1 and 4 lights flash

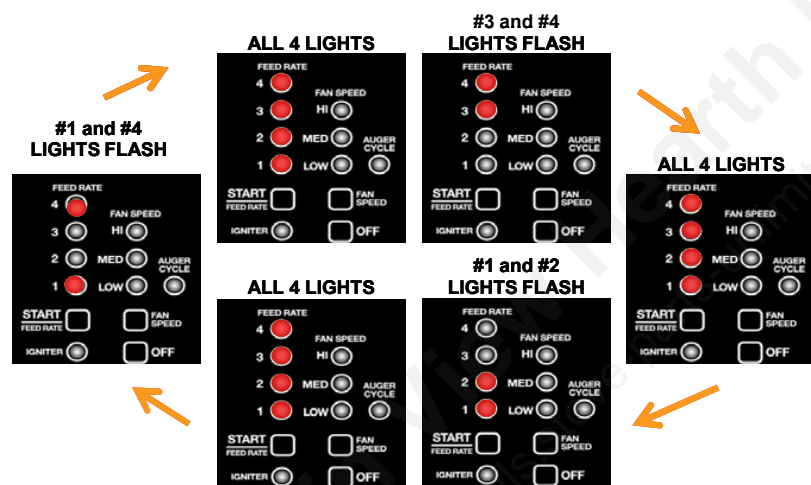

TRIM POTS (Fine tune adjustments)

FUEL FEED rates at the Lowest (#1 feed rate) and highest (#4 feed rate) settings can be set by adjusting the fine tune trim pots located on the control panel. To **raise fuel feed** turn the trim pot **counter** clockwise and to **lower the fuel feed** turn it **clockwise**.

FAN (combustion) TRIM: this trim may be used to raise or lower the amount of air moving through the burn grate for the cleanest burn, **ONLY** when the control is set on the LOW FEED RATE (#1). Only adjust this after the air inlet damper has been set during the high feed rate (#4).

NOTE: When adjusting the trim pots use a small precision screwdriver. The trim pots do not make a full rotation. If using a metal screwdriver be gentle as the plastic trim pot slot can be damaged or stripped.

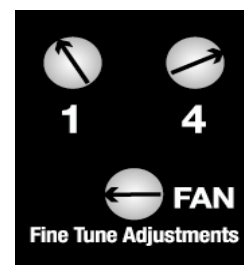



Vacuum Switch Installation Instructions



Parts Included

- 1 vacuum switch
- 1 mounting plate

Recommended Tools:

- 1/4" Hex nut driver
- 1/4" Drill Bit & drill

NOTE: Always Disconnect Power Before Performing Service Work

1. Disconnect the power supply to the stove and remove side panel.
2. Find the picture below that shows the vacuum switch that is currently in your stove and follow the instructions that go along with it. A, B, or C

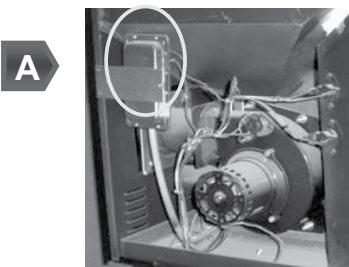

- Instructions:**
1. Remove hose and wires from old switch.
 2. Remove screws from old vacuum switch
 3. Separate the new vacuum switch from the mounting plate that comes with it
 4. Attach hose to the GREY PORT on the new vacuum switch
 5. Attach wires to new vacuum switch
 6. Mount new switch onto metal plate as shown in the picture to the right (only one screw is necessary)

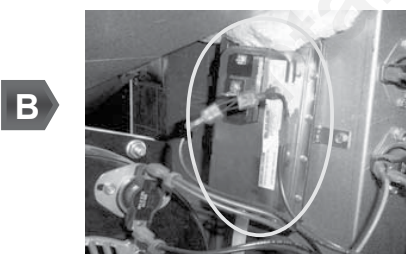
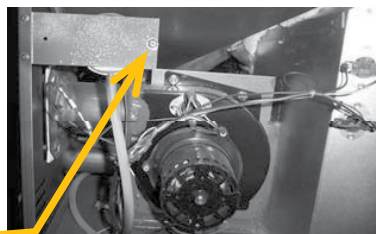

- Instructions:**
1. Remove hose and wires from old switch.
 2. Remove screws
 3. Drill 2 holes on back corner of stove to mount new switch and mounting plate.
 4. Attach hose to the GREY PORT on the new vacuum switch
 5. Attach wires to new vacuum switch
 6. Mount new vacuum switch with metal plate onto stove as shown in the picture below

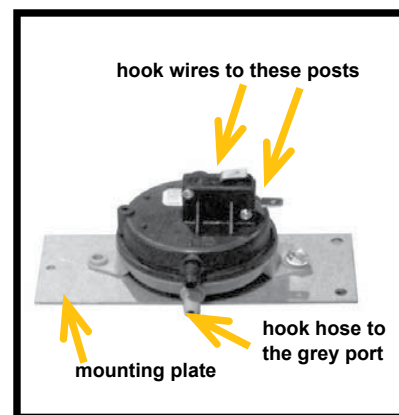

OR

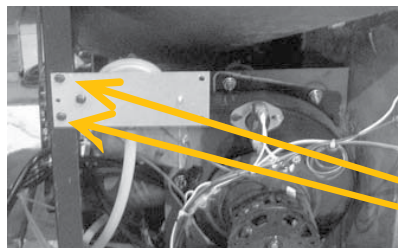
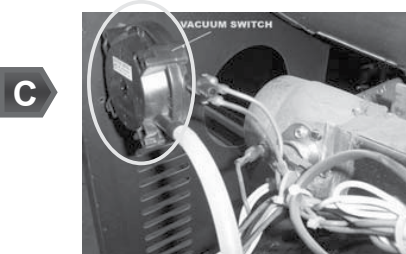

holes need to be drilled here before plate can be mounted

Hopper Lid Switch Installation Instructions



Parts Included

- 1- Hopper Lid Switch

Recommended Tools:

- 7/16" Socket

NOTE: Always Disconnect Power Before Performing Service Work

Installation:

1. Remove left side panel
2. Unplug wire from switch
3. Remove two screws. Fig. A
4. Pull out metal box
5. Remove two screws and bolts holding hopper switch in place Fig. B
6. Remove the old hopper switch
7. Before inserting new hopper switch (A) bend the metal tab into a "U" so the "U" hits the clicker. Bend the angle such that the hopper lid forces the tab down (B). Fig. C & D
8. Reassemble the hopper lid switch by reversing steps 5 - 1

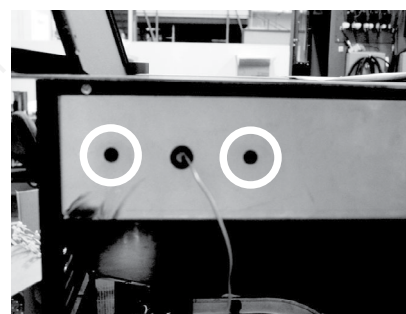

Fig. A



Fig. B

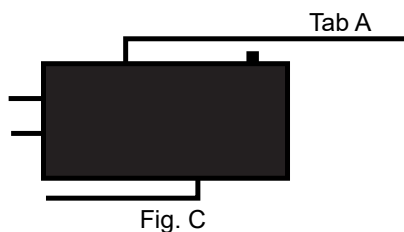

Fig. C

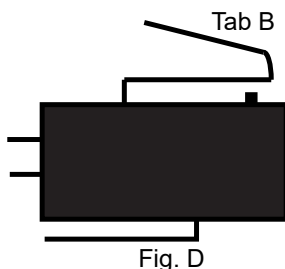

Fig. D

Automatic Safety Features



L250 HIGH LIMIT SWITCH

Your pellet appliance has a high temperature limit switch installed. If the temperature at the back of the firebox reaches approximately 250°F., the switch will shut off the electricity going to the Vacuum Switch and to the Auger Motor. The auger will automatically stop, and the appliance will shut down when the exhaust temperature cools (120deg F). IT IS IMPORTANT TO FIND THE REASON WHY THE APPLIANCE OVERHEATED

L120 LOW LIMIT SWITCH

This limit switch is mounted on the exhaust blower housing and has 2 main functions.

1. Should the fire happen to go out, for any reason, this limit switch will shut the stove off when the exhaust temperature drops below 120°F.
2. Upon starting the appliance, the AcuTron control board has a 15 minute "Lighting Mode", if the stove exhaust does not reach 120°F in that 15 minutes the stove will shut off. As soon as the stove exhaust does reach 120°F, the limit switch opens and the AcuTron enters a 5 minute "Safety Delay" mode.

F140 FAN LIMIT SWITCH

Your pellet appliance has a convection fan control limit switch. The room air fan's (F140) temperature limit snap switch automatically sets the fan on high when your stove is producing heat faster than the fan is carrying it into the room. This may occur when the heat control lever is set at [3 or 4] and the FAN SPEED is set to a very low or off setting. After the fan runs at this automatic high setting a few minutes, it may cycle back to its lower setting and may continue to cycle between [HIGH] and your selected setting. The circulation (room air) fan cycling from high to low is a normal condition as well as a safety feature of your appliance. To compensate for the fan cycling, adjust the FAN SPEED to a higher setting.

VACUUM SWITCH

This safety device (mounted on the back panel pillar) detects vacuum in the exhaust system, firebox, and air intake. If the exhaust blower fails, the vent pipe becomes plugged, the viewing door is open, this switch will sense that there is no airflow or lack of vacuum and will stop the auger from continuing to feed pellets.

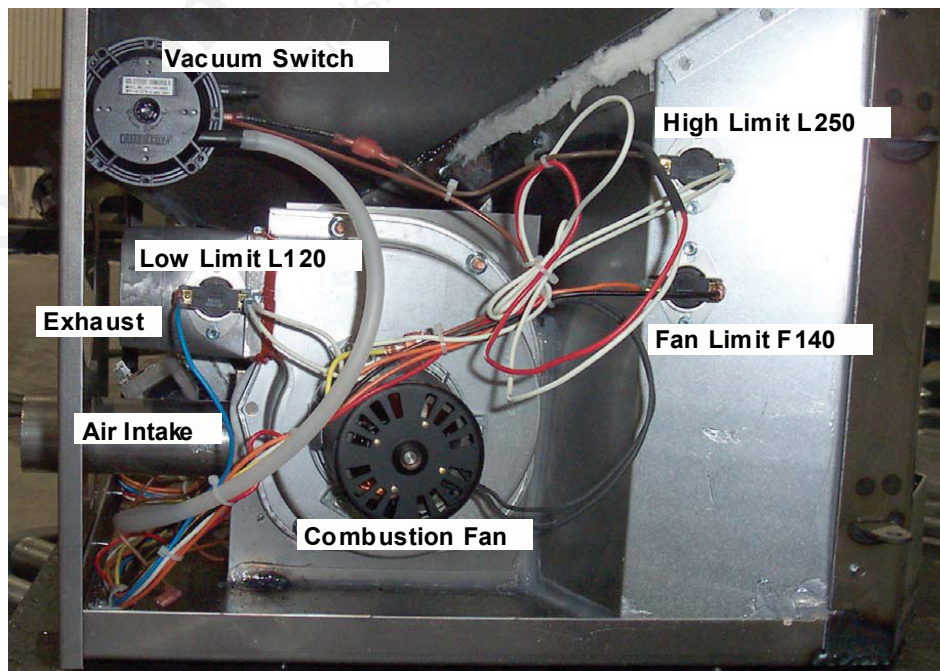

ACUTRON 4 REPAIR PROCEDURES

Automatic Safety Features

ACU-TRON WIRING HARNESS

Connection	Wire Color	Connection Type	Termination	Lead From
Igniter	Red White	White 2 Prong Male Plug	White Female Igniter Plug	Control Board Common
L250 Hi Limit Switch	White	Straight Female	Post	Common
	Brown	Straight Female	Post	Vacuum Switch
F140 Low Limit Switch	Black	Straight Female	Post	Sta-Clean Grate, Power cord
	Orange	Straight Female	Post	Convection fan
Vacuum Switch	Brown	Straight Female	Post	Auger Motor
	Brown	Straight Female	Post	Hi Limit Switch
Igniter Limit Switch (L120)	Blue	Straight Female	Post	Control Box
	White	Straight Female	Post	Common
Combustion Fan	Yellow	Straight Female	Fan Male Connector	Control Box
	White	Straight Male	Fan Female Connector	Common
Auger Motor	Tan	Straight Female	Post	Control Box
	Brown	Straight Female	Post	Vacuum Switch
Optional Sta-Clean Grate	Black	Straight Female	Male Connector	Power, Control Board, F140
	White	Straight Female	Male Connector	Common
Convection Fan	Orange	Straight Male	Fan Female Connector	F140
	White	Straight Female	Fan Male Connector	Common
Power Cord	White	Straight Male	Female Connector	Common
	Black	Straight Female	Male Connecto	Control Board, Sta-clean Grate, F140

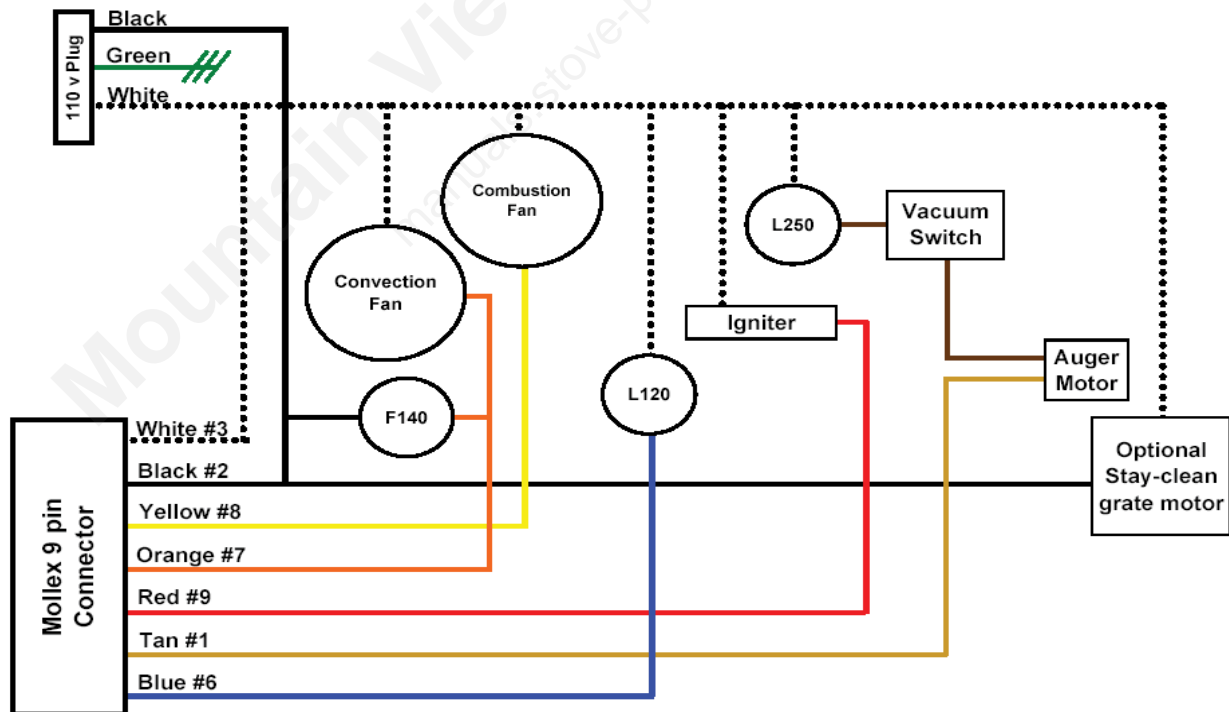

NOTE: Connector pin positions 4 and 5 are empty

Auger Shaft Assembly

Installation Instructions



Recommended Tools:

- 5/32" Allen Key
- 1/4" Hex Nut Setter
- Socket Driver
- RTV Silicone
- Side Cutters or Knife

NOTE: Always Disconnect Power Before Performing Service Work

Instructions:

1. Unplug the stove power cord from the wall outlet. Fig A
2. To gain access to the back of the appliance, remove the 1/4" hex screws from the four corners of the REAR SLOTTED ACCESS PANEL. This is located on the back lower side of the appliance. Fig B
3. Locate the position of the SET SCREW (F) located on the LOCK COLLAR (E). You will find it easier to service if the set screw is facing directly toward the combustion fan or left hand side panel. Fig D
4. You may have to plug the unit back in, Press the Start button to activate the auger motor. When the set screw is facing directly toward the left hand side panel, unplug the stove to stop the auger cycle.
5. Disconnect the two wires from the auger motor.
6. Loosen the SET SCREW (F) on the lock collar.
7. Remove the SET SCREW (B) completely from the auger mounting bracket. This is found on the control board side of the auger, and secures the auger motor to the auger feed tube. Fig E
8. Gently slide the motor backwards and away from the auger shaft and tube.



Fig A



Fig B

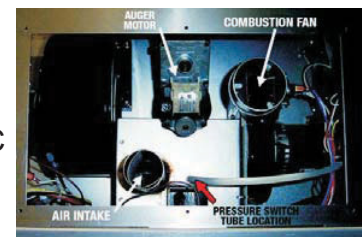

Fig C

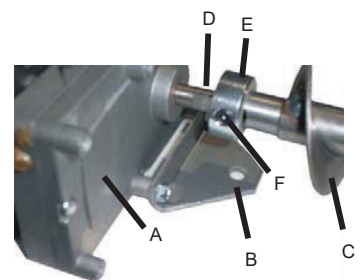

Fig D



Fig E

ACUTRON 4 REPAIR PROCEDURES

Auger Shaft Assembly

Instructions (Continued):

9. Scrape off red RTV silicone around auger shaft. Fig F
10. Open hopper lid & remove any existing pellets.
11. Remove auger cover plate by unscrewing 4 bolts. Fig G
12. Push auger shaft out of auger tube.
13. Remove first auger bushing from auger tube & replace.
14. Remove second auger bushing from auger shaft.
15. Replace auger shaft.
16. Re-assemble auger shaft by reversing steps 12-1.



Fig F



Fig G

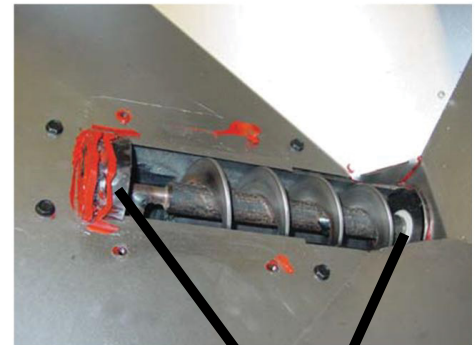

Auger Bushing Locations

Super Grate

Installation Instructions



NOTE: Always Disconnect Power Before Performing Service Work

Diagram A

The SUPER GRATE multi-Fuel Burn Grate comes in one piece: (B) and sits in the Burn Pot (A)

Diagram B

Ensure the Multi-Fuel Burn Grate (A) is properly seated in the burn pot and holes are free from obstructions. The burn grate front lip must sit firmly on the top of the burn pot.

Diagram B and C

You may need adjust the spacer tab (C) if the burn grate fits loosely in the burn pot or if the Igniter hole needs to be closer to the igniter. To do so grasp the burn grate adjustment tab (C) with a pair of pliers and bend it slightly inward or outward, until the burn grate top rest tightly onto the burn pot and grate fits firmly, with slight play, in the burn pot.

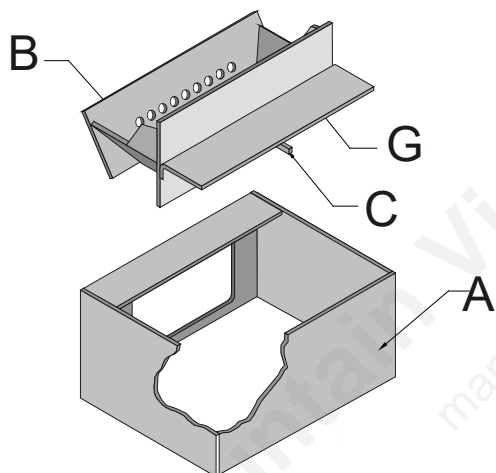

Diagram A

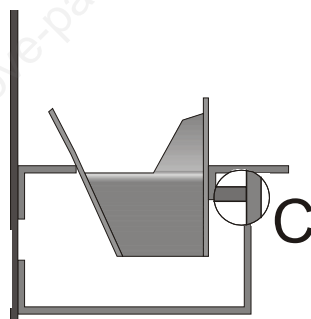

Diagram B

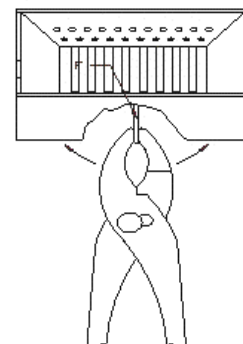

Diagram C

Snap Disc Installation Instructions



Parts Included

- 1- Snap Switch
- 2- Screws
- 1- Bracket

Recommended Tools:

- 7/16" Socket
- Philips Screw Driver

NOTE: Always Disconnect Power Before Performing Service Work

Installation:

1. Unplug stove's power cord from wall outlet.
2. Remove left side panel and locate defective snap switch.
3. Unplug power lead from defective snap switch.
4. Unscrew bolts from snap switch and remove the defective one.
5. Screw in bracket onto the appliance.
6. Screw in bolts to hold snap switch in place.
7. Plug in power leads into snap switch.
8. Re-install left side panel and plug stove into wall outlet.

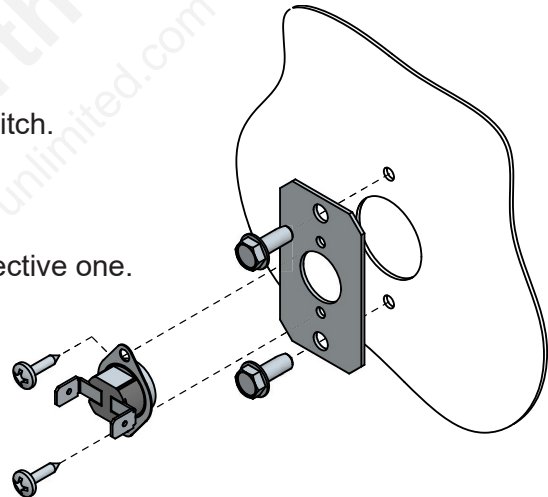

** For KS-5100-1340: When replacing a snap switch mounted to the exhaust blower on a pre-2013 appliance an extra hole will need to be drilled and plugged with the original screw. See photo

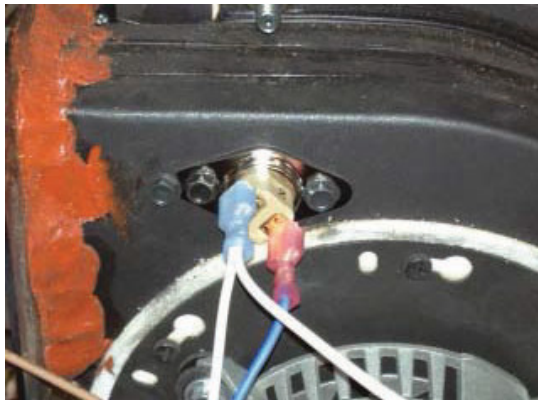

Feed Assembly Replacement Instructions



Parts Included

- 1 - Auger shaft
- 1 - Fitting
- 1 - End cap bottom
- 1 - Feed motor and feed motor bracket
- 1 - Collar, set screw & jumper
- 2 - Bushings (upper & lower)

Recommended Tools:

- Phillips Screwdriver
- 5/16" Hex Nut Driver
- Pliers or 7/16" Wrench
- 5/32" Allen Wrench
- Hammer

NOTE: Always Disconnect Power Before Performing Service Work

Instructions:

1. Empty hopper and remove the 4 screws and cover plate. Fig. 1
2. Remove remaining pellets in feed assembly.
3. Unplug feed motor from wire harness. Fig. 2
4. Remove silicone from around bushing end cap. Remove 2 screws retaining the end cap to the feed tube. Fig. 3
5. From inside the hopper, lightly tap on the end cap alternating side to side to remove feed assembly from feed tube. Fig. 4
6. Reinstall new feed assembly in reverse order. Ensure that the top feed bushing (Fig. 5) is in place and the bushing end cap is symmetrical in the feed tube prior to final tightening of the retaining screws. Silicone the end cap to the feed tube.

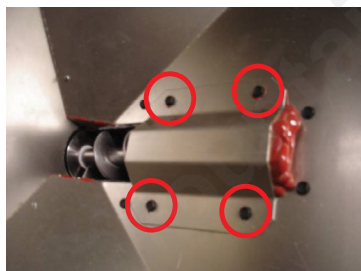

Fig. 1



Fig. 4



Fig. 2

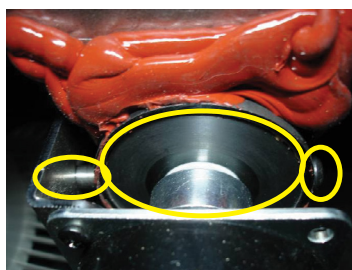

Fig. 3

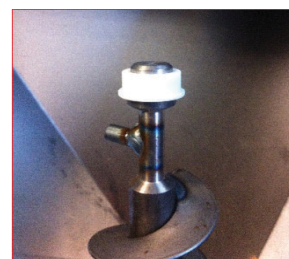

Fig. 5



Handle Assembly

Installation Instructions



Parts Included

- 1- Stove Door Handle
- 1- Handle Latch
- 1- Nut
- 1- Washer
- 1- Rolled Spacer

Recommended Tools:

- 3/8" Allen Wrench

NOTE: Always Disconnect Power Before Performing Service Work

Instructions:

1. Open the door.
2. Remove nut.
3. Remove handle latch (2), rolled spacer, and washer.
4. Remove door handle & replace.
5. To reassemble, follow steps 3-1 in reverse order.

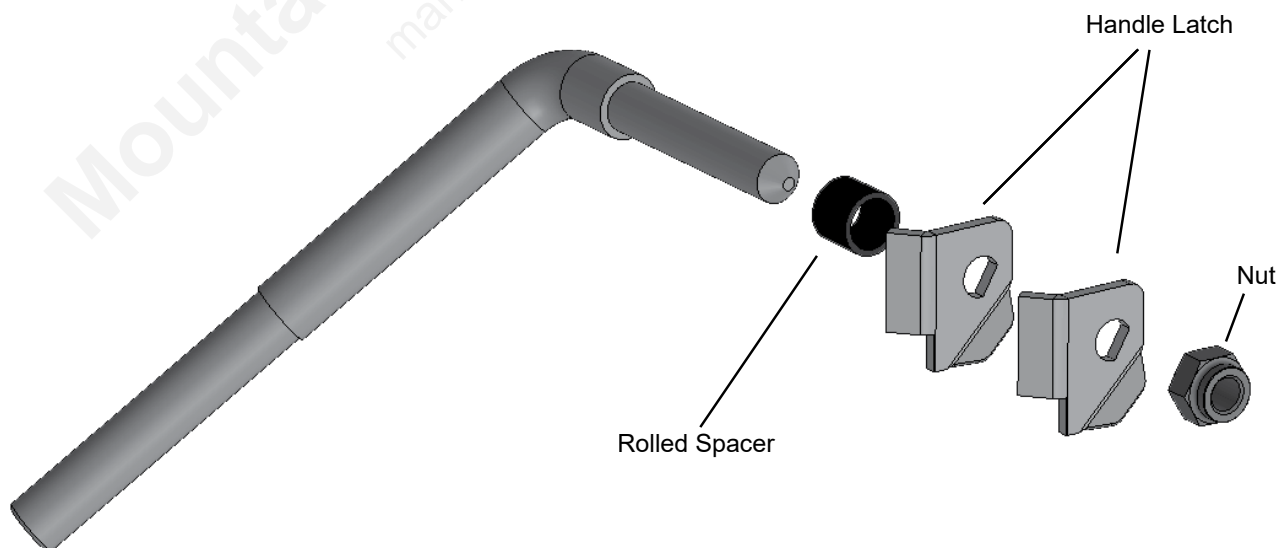

ACUTRON 4 APPLIANCES
ACUTRON 4 SPECIFICATIONS

WATTS:	
EXHAUST BLOWER	55w
CONVECTION BLOWER	288w
IGNITER	300w
FEED MOTOR	15w
AMPS:	
EXHAUST BLOWER	1.0A
CONVECTION BLOWER	2.4A
IGNITER	2.5A
FEED MOTOR	125mA
CONVECTION BLOWER VOLTS:	
LOW TO HIGH (VAC)	70v to 120v
EXHAUST BLOWER VOLT	
LOW	80v
MEDIUM	90v
MEDIUM HIGH	100v
HIGH	120v
FEED MOTOR CYCLE TIMES: (feed motor is always on for 3 seconds)	
LOW	13 to 21 sec
MEDIUM	10.5 sec
MEDIUM HIGH	9 sec
HIGH	7 to 10 sec
BTU INPUT:	
LOW	10,500
MEDIUM	
MEDIUM HIGH	
HIGH	50,000
CONVECTION BLOWER CFM:	250

Note: Appliance plugged into a 120V outlet. Voltages can vary depending on volts from the outlet.

Mountain View Hearth Products
manuals.stove-parts-unlimited.com