

QUADRA-FIRE®

CONTOUR PELLET STOVE SERVICE MANUAL



HEARTH & HOME
technologies™

1445 N. Highway
Colville, Wa 99114

#250-7610 February 10, 2003

www.quadrafire.com
www.quaddealer.com

CONTOUR PELLET STOVE SERVICE MANUAL

TABLE OF CONTENTS

SECTION	<u>PAGE</u>
TROUBLE-SHOOTING SYMPTOMS	3-5
FEED MOTOR TROUBLE-SHOOTING	6-7
IGNITER TROUBLE-SHOOTING	8-9
EXHAUST BLOWER TROUBLE-SHOOTING	10-11
CONVECTION BLOWER TROUBLE-SHOOTING	12-13
POWER SUPPLY TROUBLE-SHOOTING	14-15
THERMOSTAT TROUBLESHOOTING	16-17
THERMOCOUPLE TESTING	18
FIREPOT & EXHAUST SYSTEM TROUBLE-SHOOTING	19-21
EXPLODED VIEW	22-23
WIRE DIAGRAM	24
DIMENSIONS & SPECS	25
CHECK-OFF SHEET	26
CLEANING & MAINTENANCE TIPS	27-28
SERVICE TOOLS	29

CONTOUR PELLET STOVE SERVICE MANUAL

TROUBLE SHOOTING & REPAIR

A. PLUG IN STOVE -- NO RESPONSE

- 1) CHECK THE POWER SUPPLY FOR 115 VOLTS
- 2) CHECK THE FUSE IN THE JUNCTION BOX (7 AMP)
- 3) CHECK SNAP DISC #3 FOR POWER
- 4) CHECK CONTROL BOX

B. CALL LIGHT ON -- NO FIRE -- NO FUEL IN FIREPOT

- 1) CHECK HOPPER FOR BRIDGING OF PELLETS
- 2) PUSH RESET BUTTON & ADJUST FEED ADJUSTMENT PLATE
- 3) CHECK THERMOCOUPLE
- 4) CHECK VENTING SYSTEM FOR OBSTRUCTIONS
- 5) CHECK VACUUM SWITCH AND VACUUM HOSE
- 6) CHECK FEED MOTOR
- 7) CHECK EXHAUST BLOWER

C. CALL LIGHT ON -- NO FIRE -- PARTIALLY BURNED FUEL IN POT

- 1) CHECK FIREPOT AND CLEAN
- 2) CHECK THERMOCOUPLE
 - *GREEN LIGHT----- 2.7 mV (\pm .5mV)
 - *RED LIGHT----- 12.0 mV (\pm 1mV)
- 3) CHECK INITIAL FEED TIME (60 SECONDS)

D. CALL LIGHT ON -- NO FIRE -- FUEL IN FIREPOT

- 1) CHECK FIREPOT FOR "CLINKER" MATERIAL
- 2) CLEAN FIREPOT
- 3) CHECK IGNITER
- 4) CHECK CONTROL BOX

CONTOUR PELLET STOVE SERVICE MANUAL

TROUBLE SHOOTING & REPAIR

E. SLOW OR SMOKEY START UP

- 1) CLEAN FIREPOT
- 2) FEED ADJUSTMENT PLATE MAY BE SET TOO HIGH
- 3) CHECK EXHAUST BLOWER AND HEAT EXCHANGER
- 4) MAKE SURE TRAP DOOR UNDER FIREPOT IS CLOSED

F. STOVE RUNS FOR 18 MINUTES -- THEN STOPS FEEDING FUEL

- 1) CHECK THERMOCOUPLE
 - *GREEN LIGHT (2.7 mVDC)
 - *RED LIGHT (12.0 mVDC)
- 2) ADJUST FEED ADJUSTMENT PLATE FOR LARGER FIRE
- 3) CHECK THERMOCOUPLE COVER
 - *COVER NEEDS TO TOUCH THE END OF THE T-COUPLE WIRE
 - *COVER SHOULD EXTEND 1 3/4" INTO FIREPOT
- 4) CHECK CONTROL BOX

G. FEED SYSTEM FAILS TO START

- 1) CHECK FRONT DOOR AND MAKE SURE IT IS CLOSED
- 2) CHECK TO SEE IF CALL LIGHT IS ON
- 3) CHECK THERMOSTAT AND #2 SNAP DISC
- 4) CHECK FEED MOTOR AND VACUUM SWITCH
- 5) CHECK EXHAUST SYSTEM FOR OBSTRUCTIONS

H. THERMOSTAT WILL NOT START UNIT

- 1) CHECK THERMOSTAT WIRES FOR CONTINUITY
- 2) CHECK THE "ACCESSORY JUMPER WIRE" ON THE J-BOX
- 3) CHECK THE RESET BUTTON
- 4) CHECK FOR POWER TO THE STOVE
- 5) CHECK CONTROL BOX

CONTOUR PELLET STOVE SERVICE MANUAL

TROUBLE SHOOTING & REPAIR

I. UNIT FAILS TO SHUT OFF

- 1) CHECK THERMOSTAT AND THERMOSTAT WIRE
- 2) CHECK THE JUNCTION BOX & WIRE HARNESS
- 3) CHECK THE CONTROL BOX

J. CONVECTION BLOWER KEEPS RUNNING OR FAILS TO START

- 1) CHECK #1 SNAP DISC
- 2) CHECK CONVECTION BLOWER
- 3) CHECK FOR VOLTAGE TO THE #1 SNAP DISC

K. STOVE CYCLES ON AND OFF -- THERMOSTAT ALWAYS ON

- 1) CHECK CONTROL BOX
- 2) CHECK VACUUM SWITCH
- 3) CHECK WIRING FOR LOOSE CONNECTIONS

L. LARGE FIRE, ASH BUILD UP & DIRTY GLASS

- 1) CHECK FIREPOT, MAY NEED TO BE CLEANED
- 2) CLEAN EXHAUST AND HEAT EXCHANGER SYSTEM
- 3) ADJUST FEED ADJUSTMENT PLATE IN THE HOPPER
- 4) CHECK CONTROL BOX FEED TIMES
 - *HIGH ----- (2.2 SECOND ON TIME)
 - *MEDIUM -- (1.6 SECOND ON TIME)
 - *LOW -----(0.9 SECOND ON TIME)

M. STOVE IGNITES -- GOES OUT -- CALL LIGHT STILL ON

“ STOVE IS INCONSISTANT IN OPERATION “

- 1) INSPECT THERMOCOUPLE AND ITS POSITION OVER THE POT
- 2) CHECK THE FEED MOTOR
- 3) ADJUST FEED ADJUSTMENT PLATE FOR A LARGER FIRE
- 4) CHECK THE EXHAUST AND HEAT EXCHANGER SYSTEM
- 5) CHECK THE VACUUM SWITCH

CONTOUR PELLET STOVE SERVICE MANUAL

FEED MOTOR TROUBLE-SHOOTING

- 1) TURN ON THERMOSTAT CIRCUIT AND MAKE SURE THAT THE CALL LIGHT IS ON.
- 2) CHECK FOR POWER AT THE VACUUM SWITCH:
 - A. IF NO POWER FROM RED WIRE----CHECK CONTROL BOX OR WIRE HARNESS
 - B. POWER ON RED BUT NO POWER ON ORANGE----CHECK VACUUM SWITCH OR VENT SYSTEM
- 3) CHECK FOR POWER AT THE ORANGE WIRE ON THE #2 SNAP DISC:
 - A. IF NO POWER FROM ORANGE WIRE----CHECK WIRE HARNESS OR RESET THE SNAP DISC
 - B. IF POWER IS PRESENT----REPLACE FEED MOTOR OR CHECK CONNECTOR PIN OR CAPACITOR

NOTE: REMEMBER THAT THE FEED CIRCUIT INITIAL FEED TIME IS 60 SECONDS. PUSH THE RESET BUTTON BEFORE EACH TEST.

CAPACITOR JUMPER WIRE. PART# 230-2150

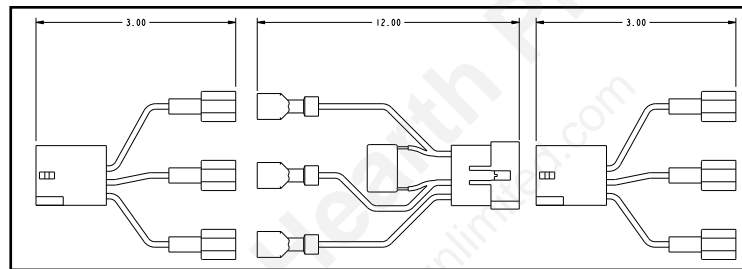

JUMPER IS NEEDED IF CAPACITOR IN J-BOX IS BAD OR IF THE MOTOR NEEDS TO BE TESTED WITH A TEST CORD.

FEED MOTOR CIRCUIT

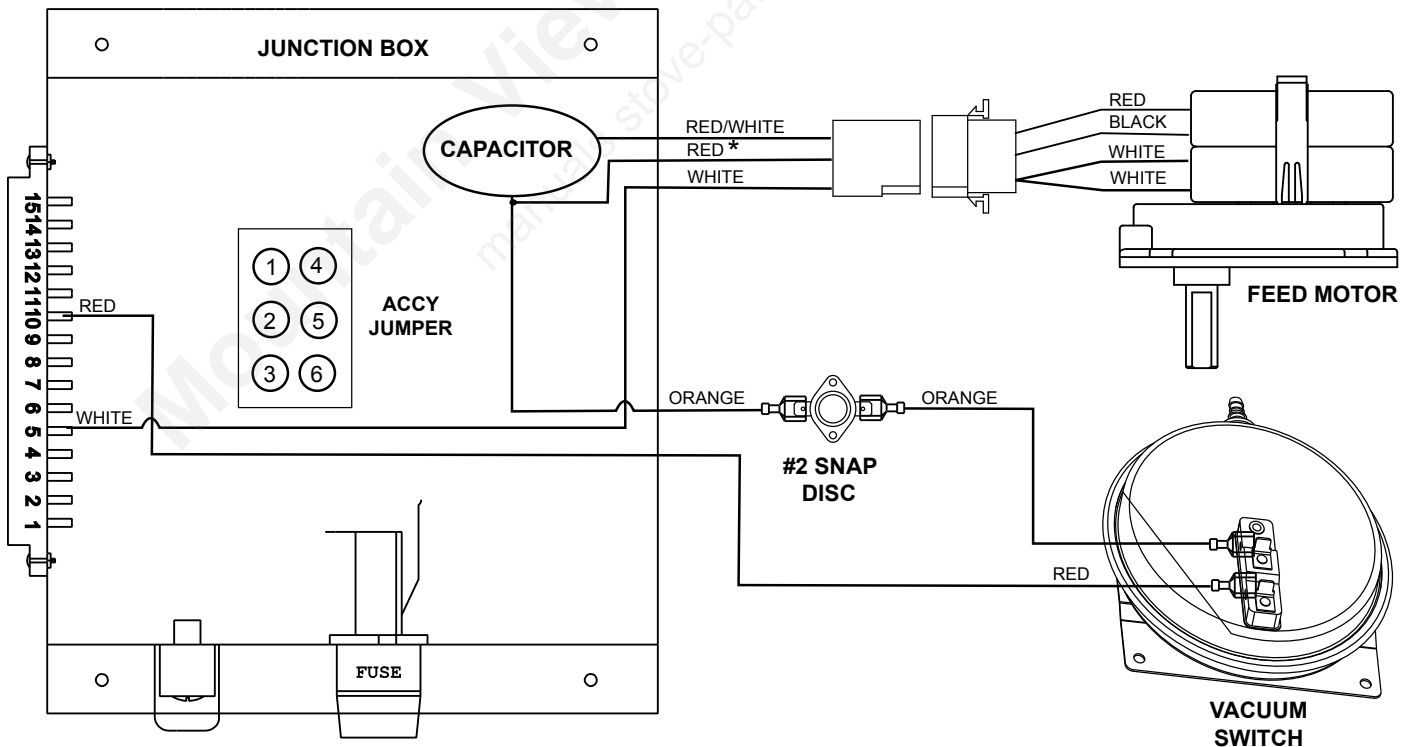

NOTE: CAPACITOR IS LOCATED IN THE JUNCTION BOX

*** Color will be black for SN 1075678 & above.**

CONTOUR PELLET STOVE SERVICE MANUAL

FEED MOTOR TESTING

USING THE TEST BOX:

- 1) UNPLUG THE STOVE, REMOVE THE CONTROL BOX, INSTALL TEST BOX & PLUG IN STOVE
- 2) TURN ON THE EXHAUST BLOWER SWITCH. (THIS WILL PULL THE VACUUM SWITCH IN)
- 3) TURN ON THE THERMOSTAT (THE THERMOSTAT INDICATOR LIGHT SHOULD COME ON)
- 4) TURN ON THE FEED MOTOR SWITCH.

IF THE FEED DOESN'T COME ON: BAD FEED MOTOR, VACUUM SWITCH, OR #2 SNAP DISC

IF THE FEED COMES ON: REPLACE CONTROL BOX

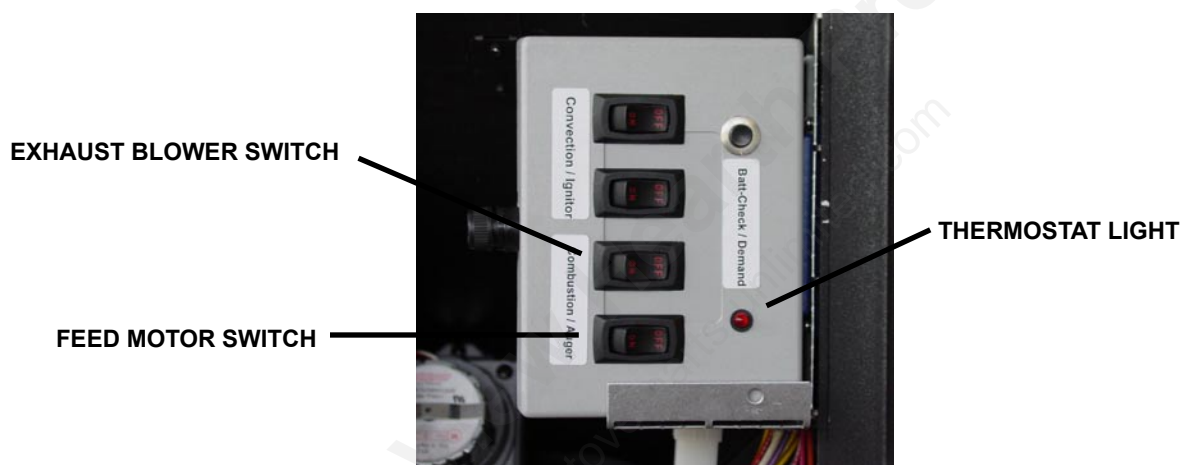

TEST BOX (AS IT IS INSTALLED IN THE STOVE)

USING THE COMPONENT TEST CORD:

- 1) UNPLUG THE FEED MOTOR FROM THE WIRE HARNESS
- 2) INSTALL THE FEED MOTOR ADAPTER ON THE TEST CORD.

NOTE: THE NEW STYLE FEED MOTOR WILL NEED THE CAPACITOR JUMPER ADDED TO THE ADAPTER.

- 3) PLUG IN THE TEST CORD TO THE FEED MOTOR AND TURN ON THE SWITCH.



TEST CORD w/ ADAPTERS

CAPACITOR JUMPER WIRE



CONTOUR PELLET STOVE SERVICE MANUAL

IGNITER TROUBLE-SHOOTING

- 1) TURN ON THE THERMOSTAT CIRCUIT AND MAKE SURE THE CALL LIGHT IS ON.
- 2) CHECK FOR POWER AT THE IGNITER:
 - A. IF NO POWER-----CHECK THE WIRE HARNESS OR REPLACE THE CONTROL BOX
 - B. IF POWER IS PRESENT-----REPLACE THE IGNITER

IGNITER CIRCUIT

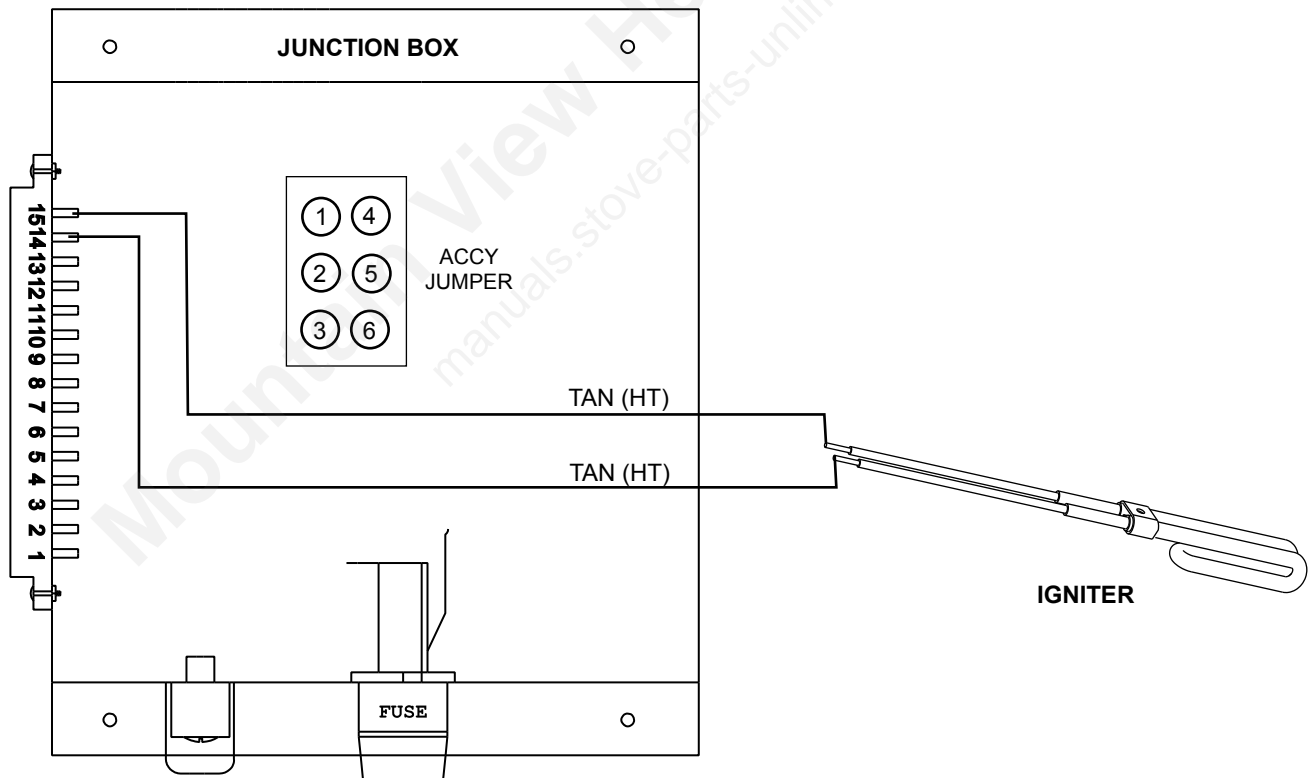

CONTOUR PELLET STOVE SERVICE MANUAL

IGNITER TESTING

USING THE TEST BOX:

- 1) UNPLUG THE STOVE, REMOVE THE CONTROL BOX, INSTALL THE TEST BOX & PLUG IN THE STOVE.
- 2) TURN ON THE THERMOSTAT. (THE THERMOSTAT INDICATOR LIGHT SHOULD COME ON)
- 3) TURN THE IGNITER SWITCH ON.

IF THE IGNITER COMES ON-----REPLACE THE CONTROL BOX

IF THE IGNITER DOESN'T COME ON-----REPLACE THE IGNITER OR CHECK THE WIRE HARNESS

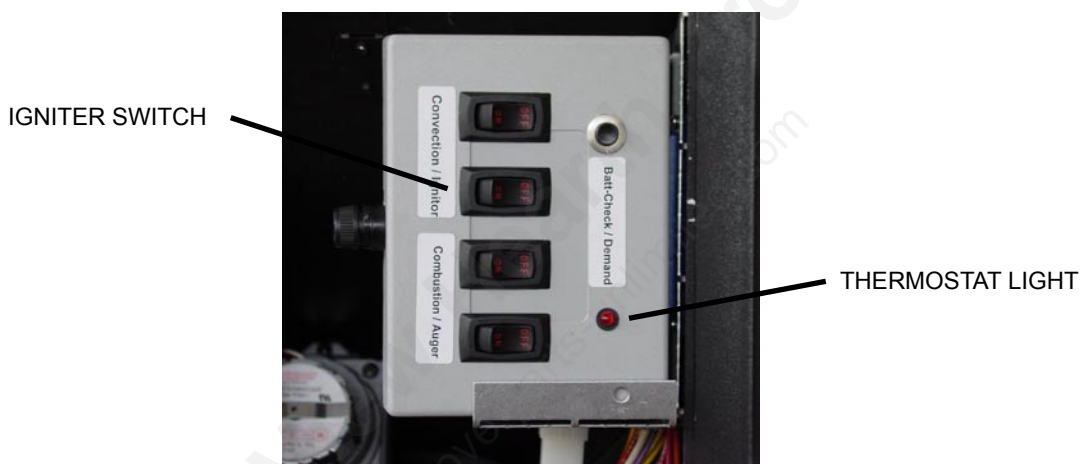

TEST BOX (AS IT IS INSTALLED IN THE STOVE)

USING THE COMPONENT TEST CORD:

- 1) UNPLUG THE STOVE AND DISCONNECT THE IGNITER FROM THE WIRE HARNESS.
- 2) INSTALL THE ALLIGATOR CLIPS ONTO THE TEST CORD.
- 3) CLIP THE TEST CORD TO THE WIRES ON THE IGNITER AND TURN THE SWITCH ON.



TEST CORD w/ CLIPS ATTACHED



CLIPS HOOKED UP TO THE IGNITER

CONTOUR PELLET STOVE SERVICE MANUAL

EXHAUST BLOWER TROUBLE-SHOOTING

- 1) TURN ON THE THERMOSTAT CIRCUIT AND MAKE SURE THE CALL LIGHT IS ON.
- 2) CHECK FOR POWER AT THE BLUE WIRE ON THE CONNECTOR.

OPEN CIRCUIT VOLTAGE AT THE BLUE CONNECTOR WILL BE 115 V ON THE HIGH SETTING ONLY.

CLOSED CIRCUIT VOLTAGE WILL BE: 115 V (HIGH) 105 V (MEDIUM) 102 V (LOW)

A. IF POWER IS PRESENT-----REPLACE THE EXHAUST BLOWER

B. IF NO POWER-----CHECK THE WIRE HARNESS OR REPLACE THE CONTROL BOX

NOTE: OPEN CIRCUIT VOLTAGE IS MEASURED WITH THE BLOWER DISCONNECTED FROM THE WIRE HARNESS. CLOSED CIRCUIT VOLTAGE IS MEASURED WITH THE BLOWER HOOKED UP TO THE HARNESS. ONE LEAD FROM THE VOLTMETER MUST BE CONNECTED TO THE BLUE WIRE ON THE MOTOR AND THE OTHER LEAD CONNECTED TO THE WHITE WIRE FROM THE POWER SUPPLY.

EXHAUST BLOWER CIRCUIT

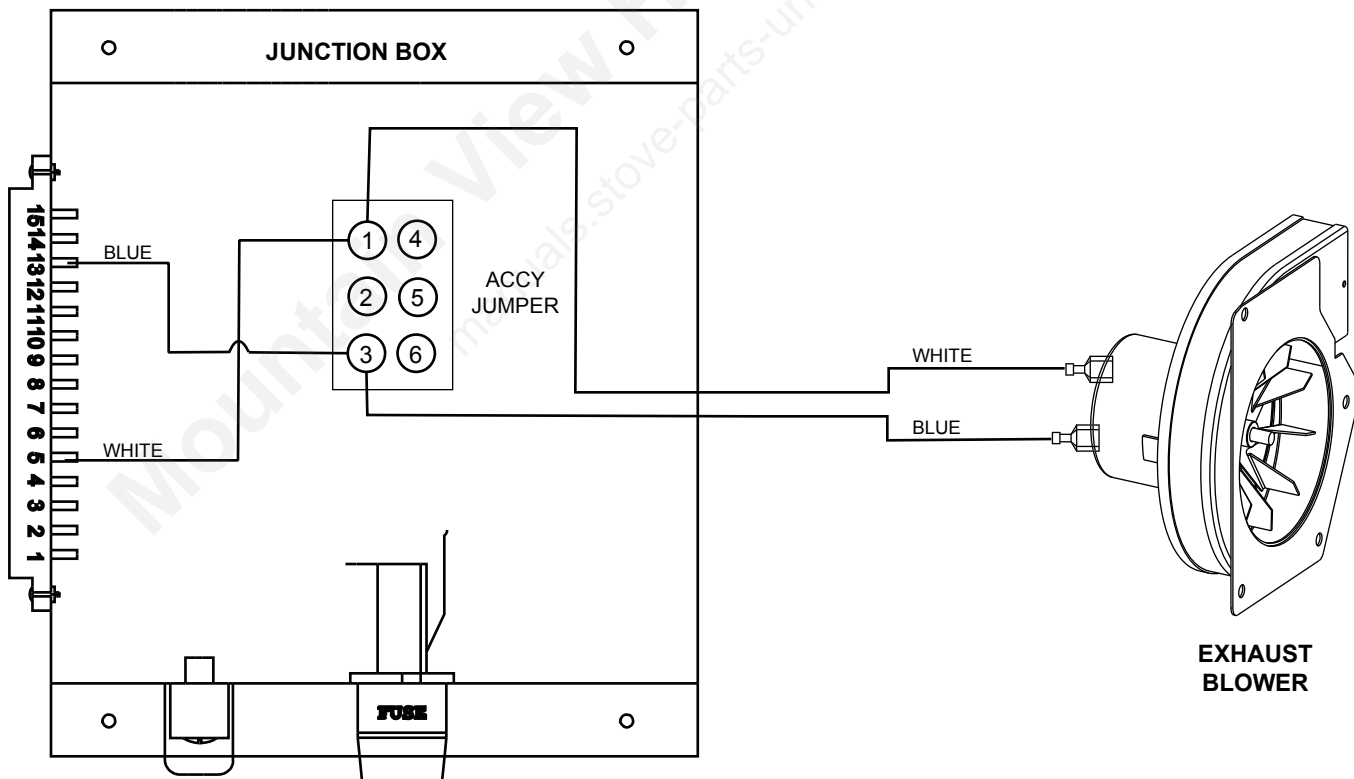

NOTE: THE ACCESSORY JUMPER IS LOCATED ON THE JUNCTION BOX HOUSING

CONTOUR PELLET STOVE SERVICE MANUAL

EXHAUST BLOWER TESTING

USING THE TEST BOX:

- 1) UNPLUG THE STOVE, REMOVE THE CONTROL BOX, INSTALL THE TEST BOX & PLUG IN THE STOVE
- 2) TURN ON THE THERMOSTAT (THE THERMOSTAT INDICATOR LIGHT SHOULD COME ON)
- 3) TURN THE EXHAUST BLOWER SWITCH ON.
 - A. IF THE BLOWER COMES ON: REPLACE THE CONTROL BOX
 - B. IF THE BLOWER DOESN'T COME ON: CHECK THE WIRE HARNESS OR REPLACE THE BLOWER

EXHAUST BLOWER SWITCH



THERMOSTAT LIGHT

TEST BOX (AS IT IS INSTALLED IN THE STOVE)

USING THE COMPONENT TEST CORD:

- 1) UNPLUG THE BLOWER FROM THE WIRE HARNESS.
- 2) INSTALL THE EXHAUST BLOWER ADAPTER TO THE TEST CORD.
- 3) PLUG IN THE TEST CORD TO THE EXHAUST BLOWER AND TURN THE SWITCH ON.



TEST CORD w/ ADAPTER ATTACHED

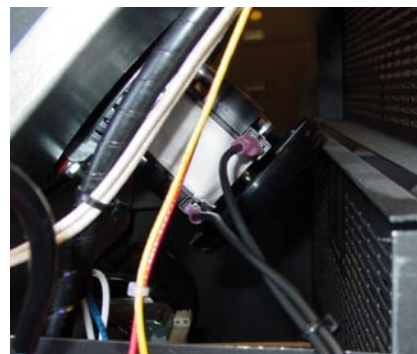

EXHAUST BLOWER w/ TEST CORD

CONTOUR PELLET STOVE SERVICE MANUAL

CONVECTION BLOWER TROUBLE-SHOOTING

- 1) CHECK FOR POWER AT THE PURPLE WIRE FROM THE #11 PIN AT THE SNAP DISC.
OPEN CIRCUIT VOLTAGE TO ONE SIDE OF SNAP DISC WILL BE 115 V FOR THE HIGH SETTING ONLY.
CLOSED CIRCUIT VOLTAGE WILL BE: 115 V (HIGH) 94 V (MEDIUM) 84 V (LOW)
 - A. IF POWER IS PRESENT ON BOTH SIDES OF THE DISC: CHECK THE WIRE HARNESS OR REPLACE THE CONVECTION BLOWER.
 - B. IF POWER IS PRESENT ON JUST ONE SIDE: REPLACE THE SNAP DISC
 - C. IF NO POWER IS PRESENT: CHECK THE FUSES & WIRE HARNESS OR REPLACE CONTROL BOX

NOTE: THE VOLT METER MUST HAVE ONE LEAD CONNECTED TO THE WHITE NEUTRAL WIRE FROM THE POWER SUPPLY TO BE ABLE TO READ THE CORRECT VOLTAGE AT THE SNAP DISC. A JUMPER WIRE CAN BE USED ON #1 SNAP DISC TO CREATE A CLOSED CIRCUIT.

CONVECTION BLOWER CIRCUIT

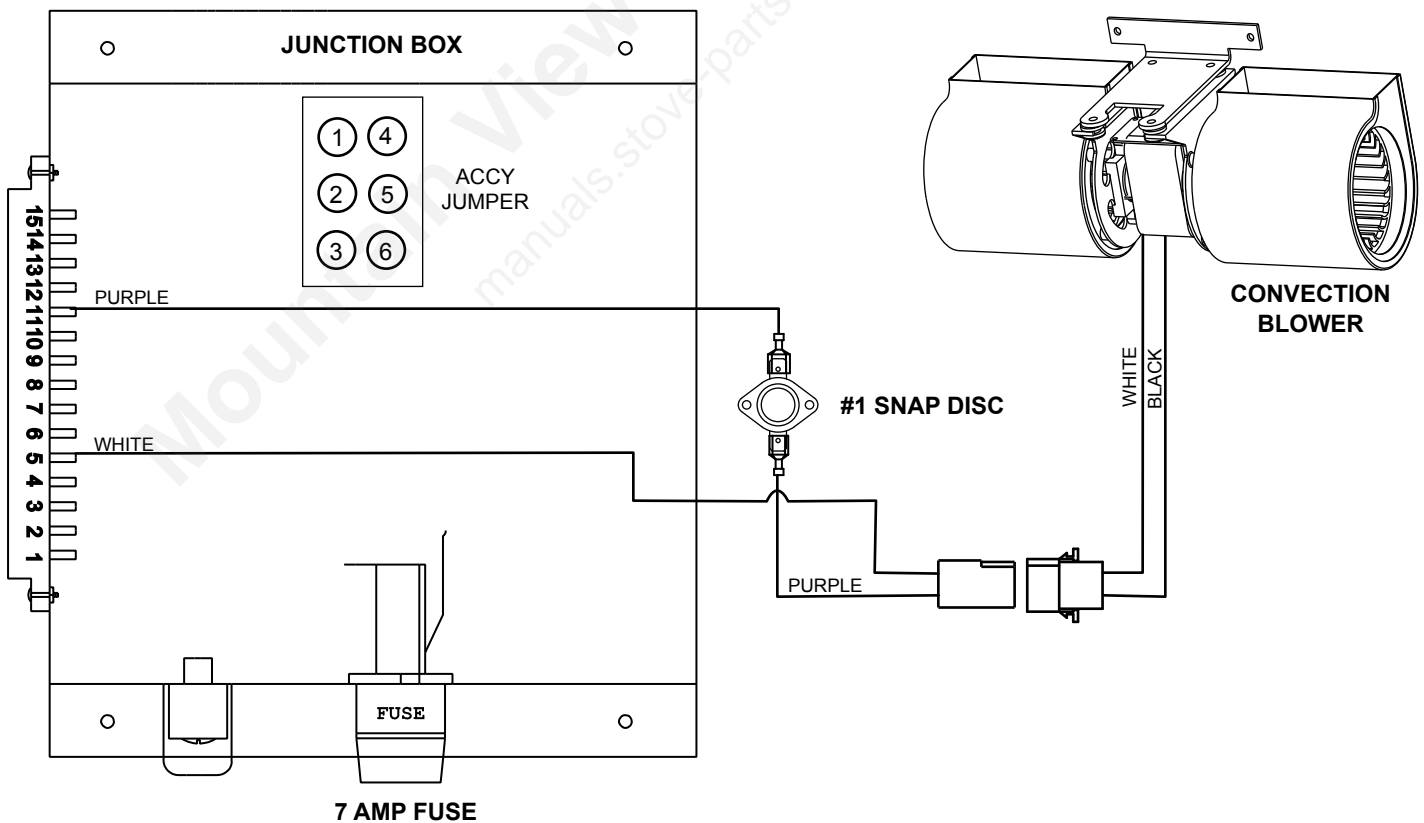

CONTOUR PELLET STOVE SERVICE MANUAL

CONVECTION BLOWER TESTING

USING THE TEST BOX:

- 1) UNPLUG THE STOVE, REMOVE THE CONTROL BOX AND INSTALL THE TEST BOX.
- 2) INSTALL A JUMPER WIRE ON THE #1 SNAP DISC (PURPLE WIRES) AND THEN PLUG THE STOVE IN.
- 3) TURN ON THE CONVECTION BLOWER SWITCH.
 - A. IF BLOWER COMES ON: REPLACE #1 SNAP DISC OR THE CONTROL BOX
 - B. IF BLOWER DOESN'T COME ON: CHECK WIRE HARNESS OR REPLACE BLOWER

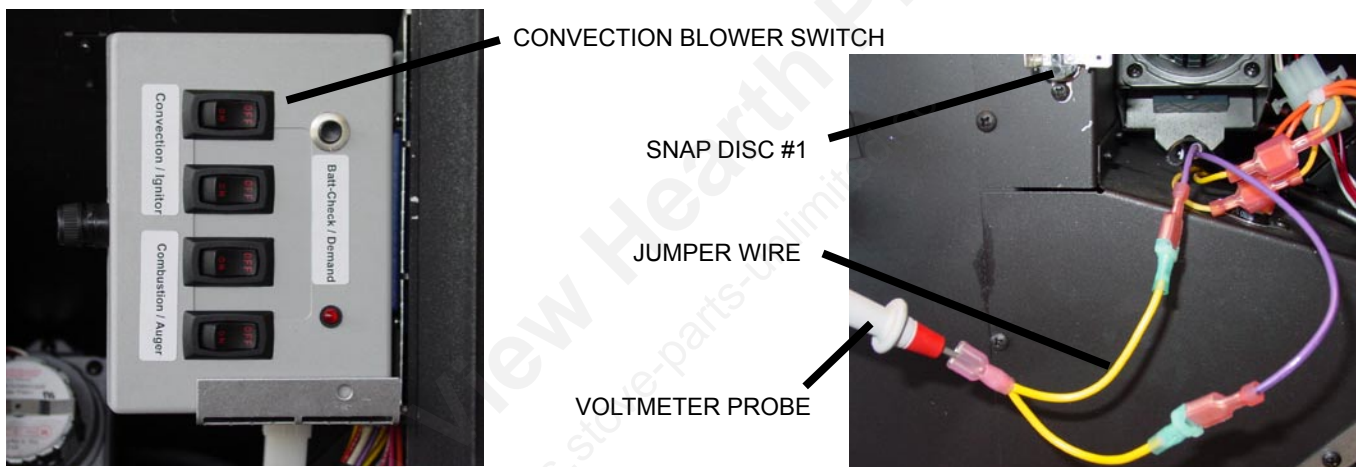

TEST BOX (AS IT IS INSTALLED IN THE STOVE)

USING THE COMPONENT TEST CORD:

- 1) UNPLUG THE CONVECTION BLOWER FROM THE WIRE HARNESS.
- 2) INSTALL THE TWO WIRE MOLEX CONNECTOR ADAPTER WIRE TO THE TEST CORD.
- 3) PLUG IN THE TEST CORD TO THE CONVECTION BLOWER AND TURN THE SWITCH ON.

NOTE: THIS WILL ONLY TEST THE HIGH SPEED OF THE BLOWER.



TEST CORD w/ ADAPTER

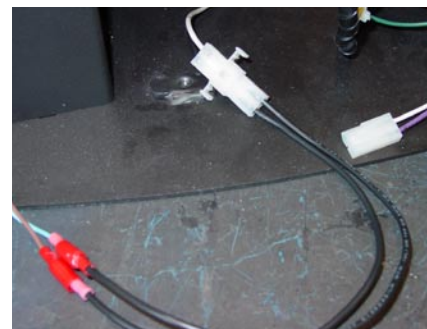

TEST CORD CONNECTED TO THE BLOWER

CONTOUR PELLET STOVE SERVICE MANUAL

POWER SUPPLY TROUBLE-SHOOTING

- 1) **CHECK FOR POWER AT THE BLACK WIRE FROM THE POWER CORD. (SEE FIG. 1)**
 - A. IF NO POWER-----CHECK OUTLET OR REPLACE POWER CORD
 - B. IF POWER IS PRESENT, CONTINUE TO STEP 2
- 2) **CHECK FOR POWER AT THE GREY WIRE ON THE 7 AMP FUSE HOLDER. (SEE FIG. 2)**
 - A. IF NO POWER-----REPLACE THE FUSE OR THE FUSE HOLDER
 - B. IF POWER IS PRESENT, CONTINUE TO STEP 3
- 3) **CHECK FOR POWER AT THE GREY WIRES ON SNAP DISC #3. (SEE FIG. 3)**
 - A. IF NO POWER-----RESET THE SNAP DISC OR REPLACE IT.
 - B. IF POWER IS PRESENT---CHECK FOR CONTINUITY AT PIN 5 (WHITE WIRE) TO POWER CORD (FIG.4 & 5) OR REPLACE THE CONTROL BOX.

POWER SUPPLY

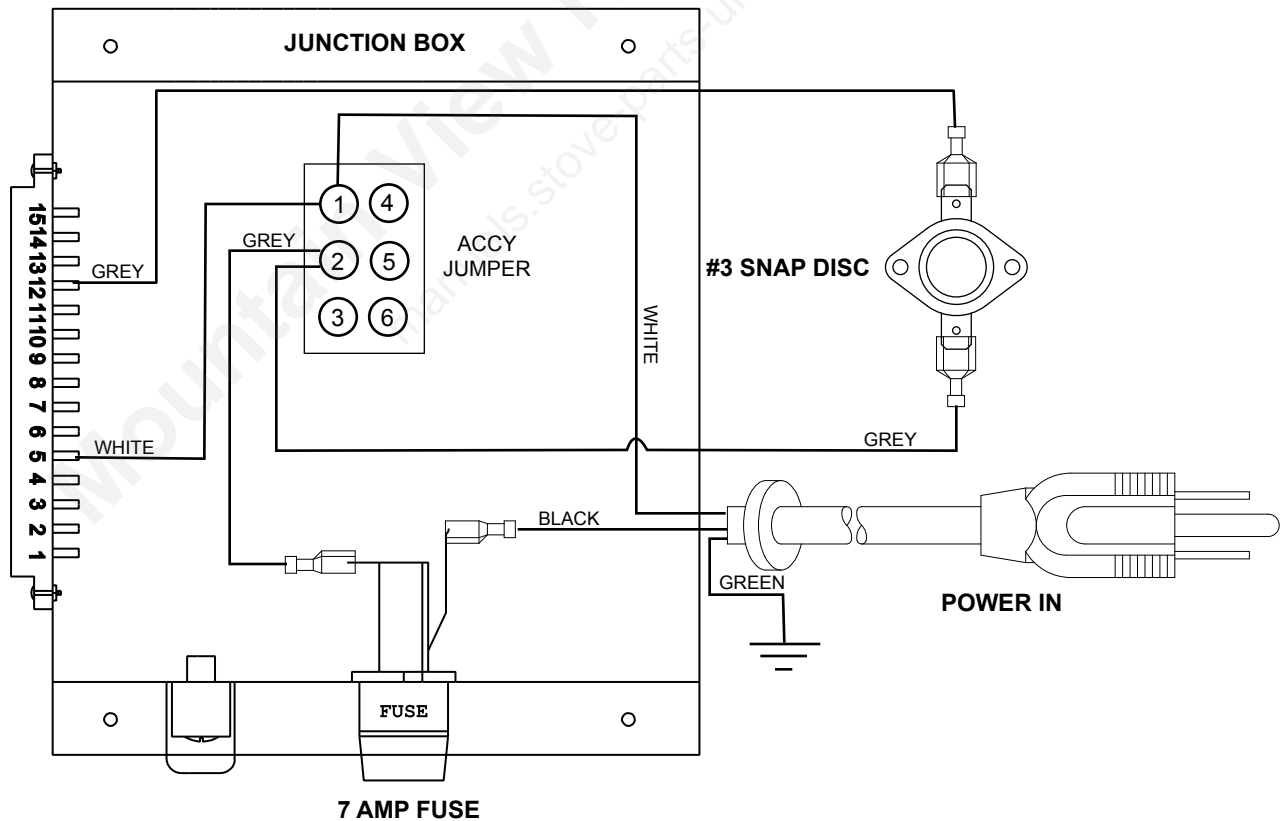

CONTOUR PELLET STOVE SERVICE MANUAL

POWER SUPPLY TESTING

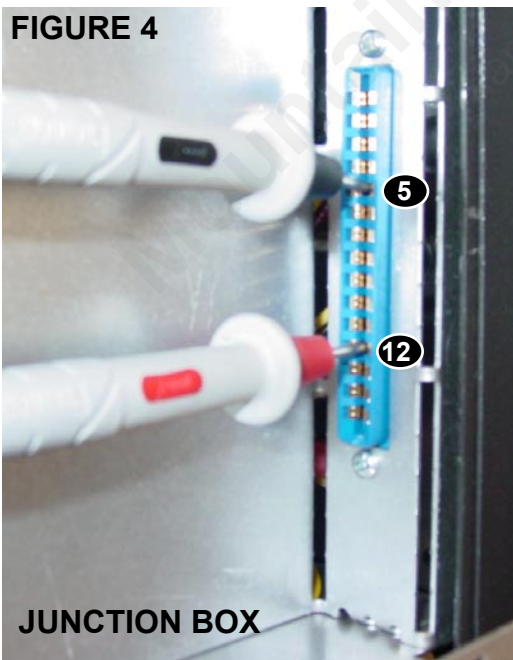
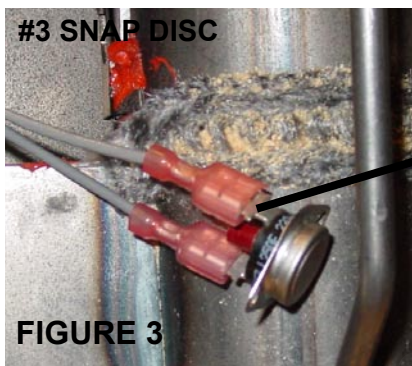
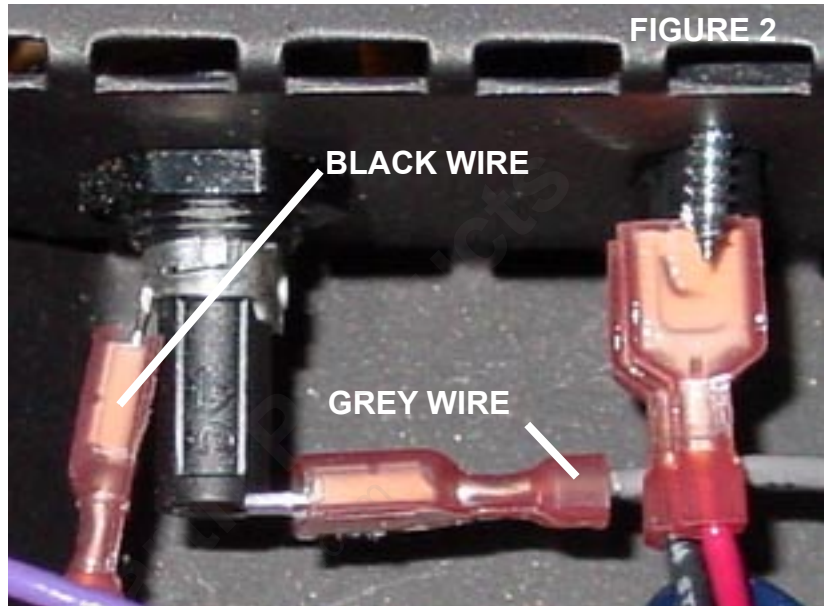
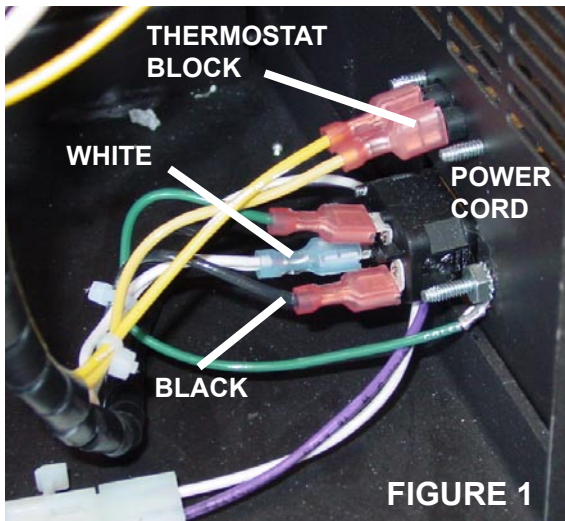

TO CHECK FOR CONTINUITY:

- 1) PUT A JUMPER WIRE ON THE END OF THE POWER CORD. (SEE FIGURE 5)
- 2) SET THE VOLT METER TO OHMS AND PUT THE PROBES ON PIN 5 & PIN 12. (SEE FIGURE 4)
IF THE CIRCUIT IS COMPLETE, THE READING SHOULD BE "0".



CONTOUR PELLET STOVE SERVICE MANUAL

THERMOSTAT CIRCUIT TROUBLE-SHOOTING

- 1) UNPLUG THE STOVE & REMOVE THE CONTROL BOX.
- 2) TURN ON THE THERMOSTAT & MAKE SURE THE ACCESSORY JUMPER IS IN PLACE.
- 3) CHECK FOR CONTINUITY AT PIN 7 & PIN 9 ON THE JUNCTION BOX.
IF THE CIRCUIT HAS CONTINUITY: REPLACE THE CONTROL BOX
IF NO CONTINUITY, CONTINUE TO THE NEXT STEP
- 4) INSTALL A JUMPER WIRE ON THE THERMOSTAT & CHECK FOR CONTINUITY AT PIN 7 & PIN 9
IF THE CIRCUIT HAS CONTINUITY: REPLACE THE THERMOSTAT
IF NO CONTINUITY, CONTINUE TO THE NEXT STEP
- 5) REMOVE THE THERMOSTAT WIRES FROM THE THERMOSTAT BLOCK & INSTALL A JUMPER WIRE.
IF THE CIRCUIT HAS CONTINUITY: REPLACE THE THERMOSTAT WIRE
IF NO CONTINUITY, CONTINUE TO THE NEXT STEP
- 6) INSTALL A JUMPER WIRE ON THE T-STAT BLOCK & THE RESET BUTTON. CHECK CONTINUITY. (7&9)
IF THE CIRCUIT HAS CONTINUITY: REPLACE THE RESET BUTTON
IF NO CONTINUITY: REPLACE THE JUNCTION BOX/WIRE HARNESS

THERMOSTAT CIRCUIT

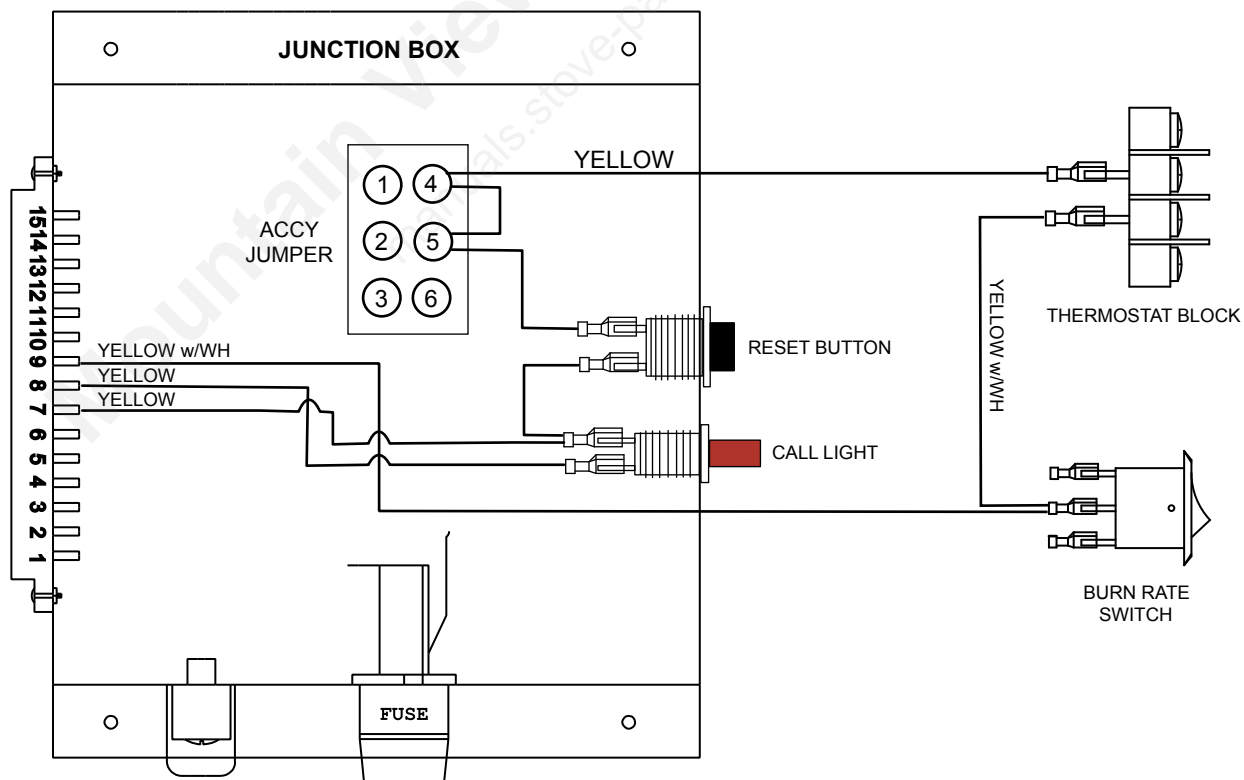

CONTOUR PELLET STOVE SERVICE MANUAL

THERMOSTAT CIRCUIT TESTING

USING THE TEST BOX:

- 1) UNPLUG STOVE, REMOVE CONTROL BOX, INSTALL TEST BOX & PLUG STOVE BACK IN.
- 2) TURN ON THE THERMOSTAT.

IF THE THERMOSTAT LIGHT COMES ON: REPLACE THE CONTROL BOX

IF NO THERMOSTAT LIGHT: REFER TO THERMOSTAT CIRCUIT TROUBLE-SHOOTING



TESTING FOR CONTINUITY ON PIN 7 & PIN 9 IN THE JUNCTION BOX.



THERMOSTAT BLOCK WITH A JUMPER WIRE ATTACHED.

THERMOSTAT
INDICATOR LIGHT



TEST BOX (AS IT IS INSTALLED IN THE STOVE)



ACCESSORY JUMPER PLUG ON THE JUNCTION BOX.

CONTOUR PELLET STOVE SERVICE MANUAL

THERMOCOUPLE TESTING

THE THERMOCOUPLE IS MADE UP OF TWO DISSIMILAR METALS THAT WHEN JOINED TOGETHER PRODUCE A SMALL AMOUNT OF ELECTRICITY WHEN HEAT IS APPLIED. THE HOTTER THE FIRE THE HIGHER THE VOLTAGE THAT IS PRODUCED. THIS THERMOCOUPLE WILL TOP OUT AT AROUND 30 MILIVOLTS (DC) WHILE THE STOVE IS BURNING ON HIGH. THE FUNCTION OF THE THERMOCOUPLE IS TO SENSE THE TEMPERATURE IN THE FIREPOT. IF THE THERMOCOUPLE IS FRACTURED, IT WILL NOT PRODUCE VOLTAGE. ALSO, THE GREEN LIGHT ON THE CONTROL BOX WILL STAY ON AND THE RED LIGHT WILL FLASH IF THE CIRCUIT IS OPEN OR IF THE THERMOCOUPLE IS FRACTURED.

1) ATTACH A DIGITAL VOLT METER TO THE TWO THERMOCOUPLE CONNECTORS ON THE HARNESS.

NOTE: BE SURE TO SET THE METER TO MILIVOLTS (DC) AND A JUMPER WIRE MAY NEEDED TO CHECK MILIVOLTS WHILE THE THERMOCOUPLE IS HOOKED UP.

2) APPLY HEAT TO THE THERMOCOUPLE TIP IN THE FIREPOT.

IF THE THERMOCOUPLE STARTS PRODUCING VOLTAGE: CHECK TERMINAL CONNECTIONS ON THE WIRE HARNESS OR REPLACE THE CONTROL BOX.

IF NO VOLTAGE FROM THE THERMOCOUPLE: REPLACE THE THERMOCOUPLE

GREEN THERMOCOUPLE LIGHT
RED THERMOCOUPLE LIGHT



CONTROL BOX

THERMOCOUPLE CONNECTORS

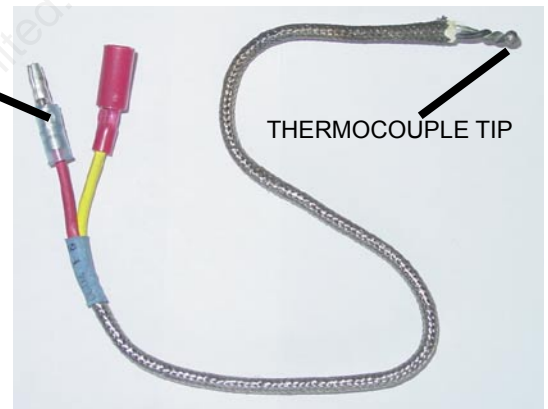

THERMOCOUPLE TIP

THERMOCOUPLE WIRE



THERMOCOUPLE TIP WITH PROTECTIVE COVER

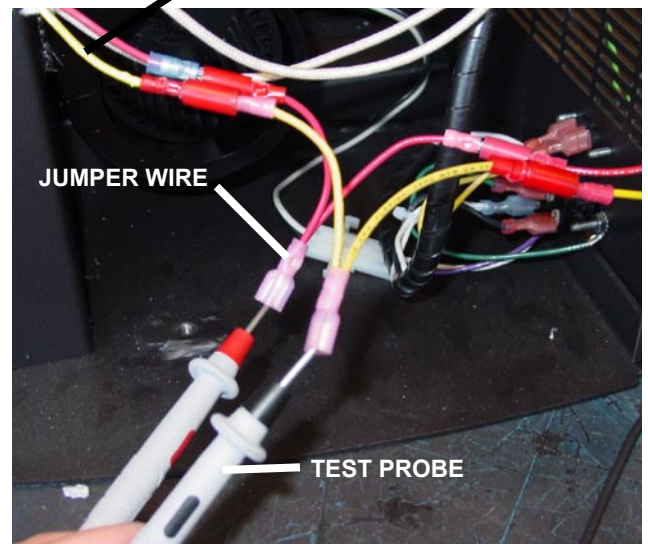

JUMPER WIRE

TEST PROBE

CONTOUR PELLET STOVE SERVICE MANUAL

FIREPOT AND EXHAUST SYSTEM TROUBLE-SHOOTING

THE FIREPOT IS MADE OF CAST STEEL AND IS DESIGNED WITH AIR INTAKE HOLES THAT SWIRL THE FIRE AND HELP TO REMOVE THE ASH CREATED FROM THE BURNING OF THE PELLET FUEL. THERE IS ALSO A SLOT OR AIR PASSAGE IN THE BOTTOM SIDE OF THE FIREPOT THAT ALLOWS HOT AIR FROM THE IGNITER TO LIGHT THE PELLET FUEL. DURING THE BURN CYCLE PROCESS IN THE FIREPOT, "CLINKER" MATERIAL WILL START TO BUILD-UP. **(SEE *FIGURE 1)** THE RATE OF THIS BUILD-UP WILL DEPEND ON THE QUALITY OF THE PELLET FUEL BEING USED. OVER TIME THIS BUILD-UP OF CLINKER MATERIAL CAN OBSTRUCT THE AIR PASSAGES AND CAN CAUSE PROBLEMS WITH THE OPERATION OF THE FIREPOT. THIS CAN ALSO CAUSE THE FIREPOT CLEAN OUT DOOR TO BECOME HARD TO PULL IF THE FIREPOT IS NOT CLEANED ON A REGULAR BASIS.

THE FIREPOT IS JUST ONE COMPONENT OF THE TOTAL COMBUSTION SYSTEM. COMBUSTION AIR FLOWS INTO A ROUND OPENING LOCATED IN THE PEDESTAL BASE IN THE BACK OF THE UNIT. **(SEE *FIGURE 2)** THIS AIR TRAVELS TO A RECTANGLE SHAPED OPENING LOCATED JUST BEHIND THE BOTTOM OF THE FIREPOT. **(SEE *FIGURE 3)** COMBUSTION AIR WILL FLOW THROUGH THE AIR OPENINGS IN THE FIREPOT AND IS THEN TRANSFORMED INTO EXHAUST GASES. THE EXHAUST GASES WILL FLOW FROM THE FIREPOT TO THE BAFFLE PLATES AND HEAT EXCHANGER TUBES. **(SEE *FIGURE 4)** THE EXHAUST WILL FLOW FROM THE HEAT EXCHANGER TUBES TO THE EXHAUST BLOWER HOUSING. **(SEE *FIGURE 5)** THIS COMPLETES THE NEGATIVE PRESSURE OR VACUUM PORTION OF THE COMBUSTION SYSTEM. AFTER THE EXHAUST ENTERS THE EXHAUST BLOWER HOUSING IT IS THEN PUSHED OUT INTO THE VENT PIPE OR CHIMNEY PORTION OF THE EXHAUST SYSTEM. **(SEE *FIGURE 6)**

IF ANY PART OF THE EXHAUST SYSTEM IS RESTRICTED, THE STOVE WILL BURN DIRTY WITH TALL LAZY FLAMES. THE STOVE MAY ALSO EXPERIENCE PROBLEMS WITH LIGHTING THE PELLET FUEL DUE TO THE REDUCED AIR FLOW THROUGH THE FIREPOT.

IF ANY PART OF THE EXHAUST SYSTEM IS BLOCKED, THE STOVE WILL NOT FEED BECAUSE THE VACUUM SWITCH WILL NOT ENGAGE. NORMALLY THE STOVE WILL HAVE BETWEEN .08 TO .11 INCHES OF WATER COLUMN IN THE FIREBOX WITH STOVE SET ON THE HIGH FEED RATE.

*** FIGURE EXAMPLES ARE LOCATED ON THE NEXT PAGE.**

CONTOUR PELLET STOVE SERVICE MANUAL

FIREPOT AND EXHAUST SYSTEM TROUBLE-SHOOTING

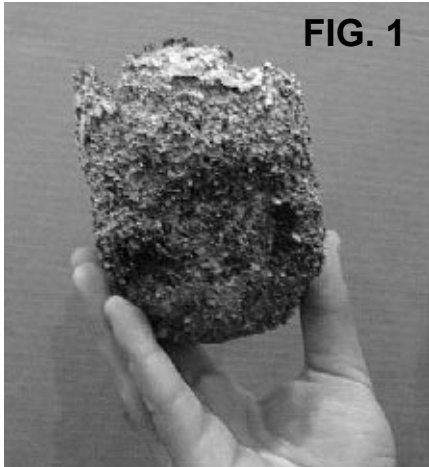

EXAMPLE OF A LARGE CLINKER

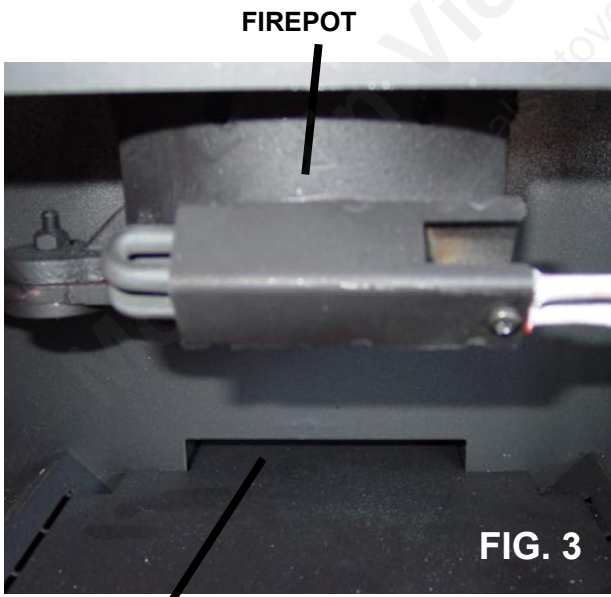
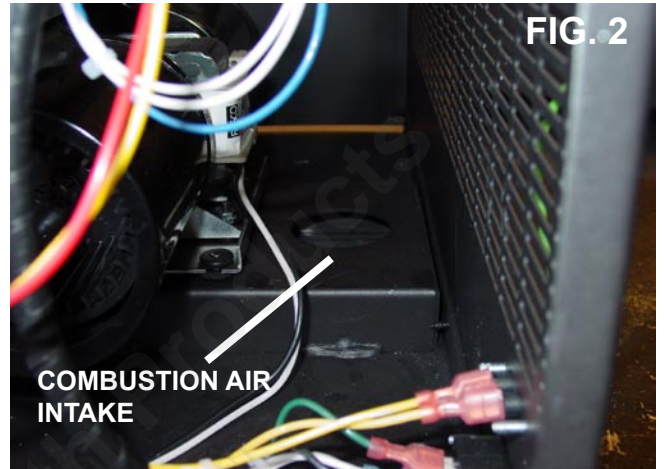

AIR INTAKE IN THE COMBUSTION CHAMBER

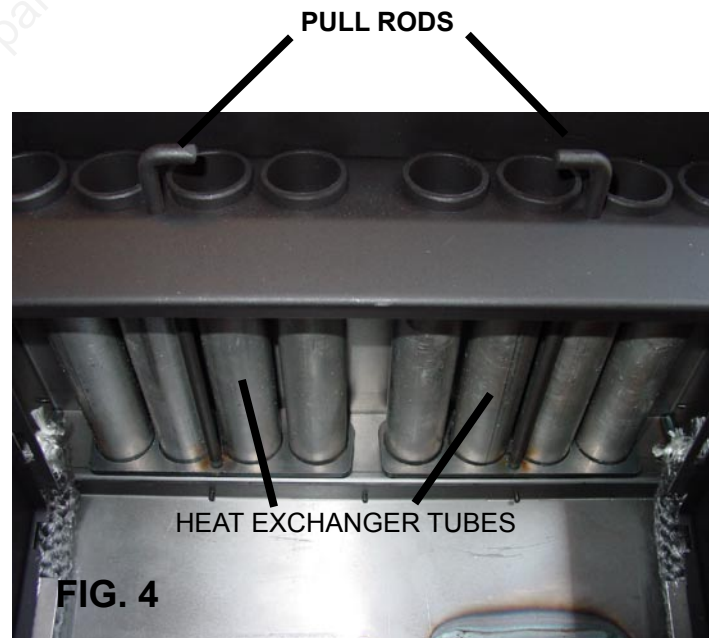

FIREBOX AREA w/ BAFFLE PLATES REMOVED

CONTOUR PELLET STOVE SERVICE MANUAL

FIREPOT AND EXHAUST SYSTEM TROUBLE-SHOOTING

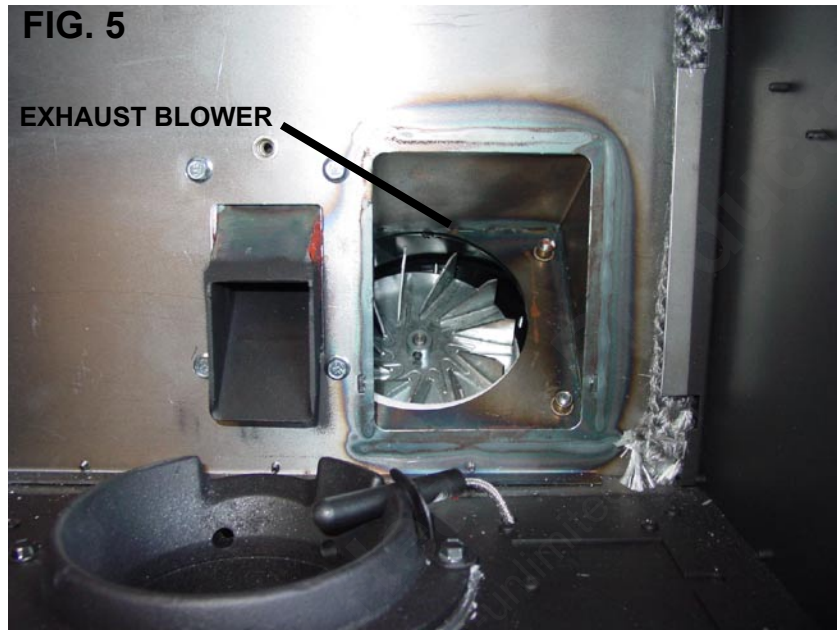

**EXHAUST BLOWER WITH
CAST BRICK REMOVED**



VENT PIPE ADAPTER

CONTOUR PELLET STOVE SERVICE MANUAL

CONTOUR EXPLODED VIEW LEGEND

1) FIREPOT GUARD.....412-0670	20) CONTROL BOX.....812-4940
2) ASHPAN ASSY.....410-2150	21) SIDE CURTAIN MNT.....412-0410
3) PED BASE.....811-0840	22) J-BOX/HARNESS.....812-4450
4) PED SIDE CURTAIN.....412-0460	23) REAR SCREEN.....812-4510
5) PED BACK STRAP.....412-0540	24) CAST HINGE.....80796
6) PED SCREEN.....412-0430	25) HOPPER LID HANDLE.....812-0850
7) CONVECTION FAN.....812-4540	26) HOPPER LID.....412-0400
8) CASTBRICK (RIGHT).....80793	27) CAST TOP.....80789
9) T-COUPLE HOLDER.....412-0830	28) BAFFLE.....812-4460
10) CLEAN-OUT PLATE.....412-0880	29) CASTBRICK (CENTER).....80792
11) DRAW LATCH.....812-3530	30) CASTBRICK (LEFT).....80791
12) MAGNET.....229-0631	31) FIREPOT.....812-4430
13) MAGNET MOUNT.....412-0600	32) IGNITER.....812-3811
14) SIDE CURTAIN (LT/RT)....412-5130	33) FIREPOT GASKET.....812-4720
15) EXHAUST FAN.....812-4400	34) W.S. GLASS.....200-2720
16) FEED SPRING.....812-4690	35) GOLD GRILL.....811-0830
17) #2 SNAP DISC.....230-1960	36) FACE ASSY.....412-5110
18) FEED MOTOR.....812-4420	37) GOLD TRIM.....811-0820
19) VACUUM SWITCH.....812-3430	38) DOOR GLASS.....812-4440

CONTOUR PELLET STOVE SERVICE MANUAL

CONTOUR EXPLODED VIEW

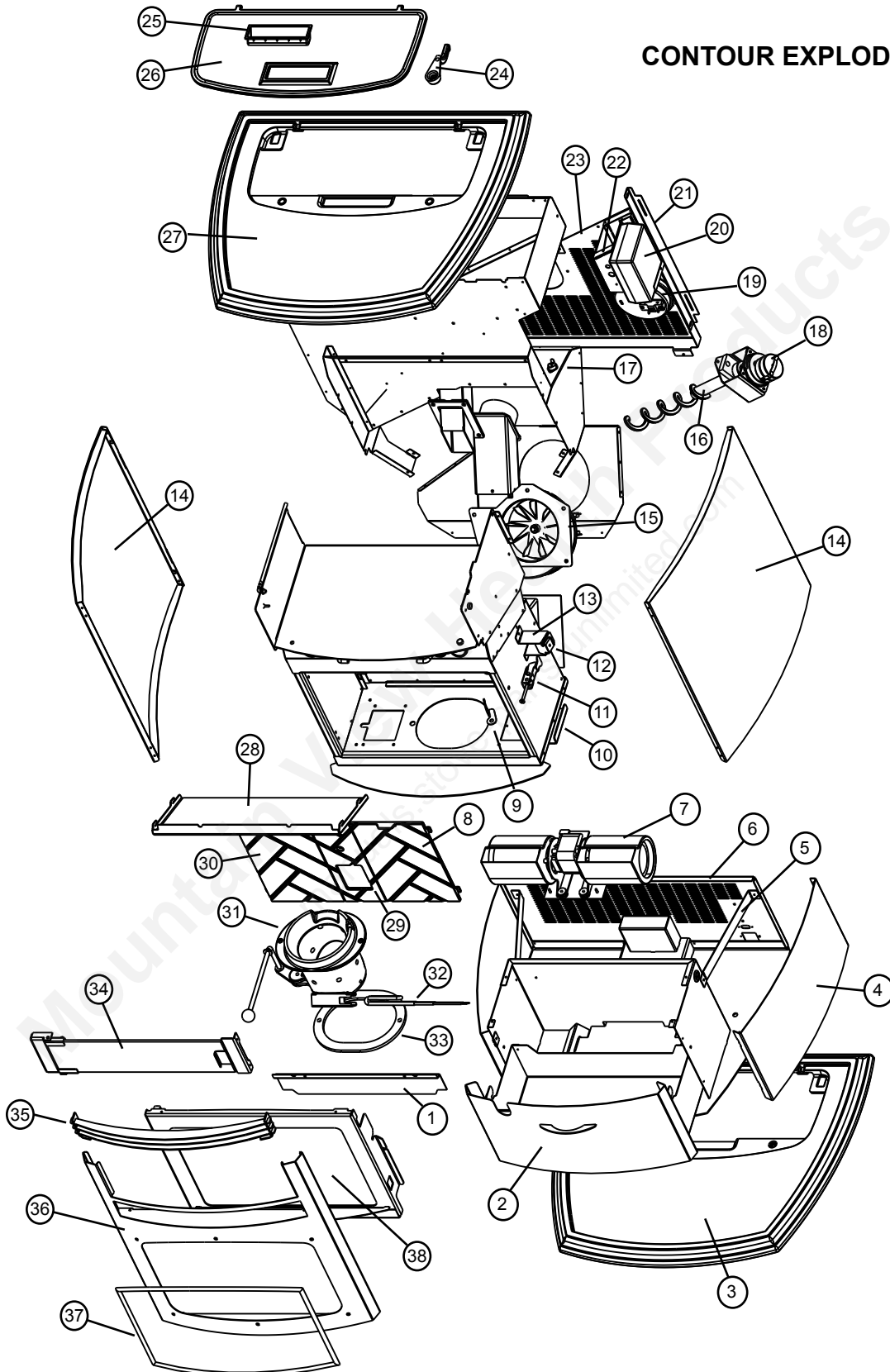

CONTOUR PELLET STOVE SERVICE MANUAL

COMPLETE WIRE DIAGRAM

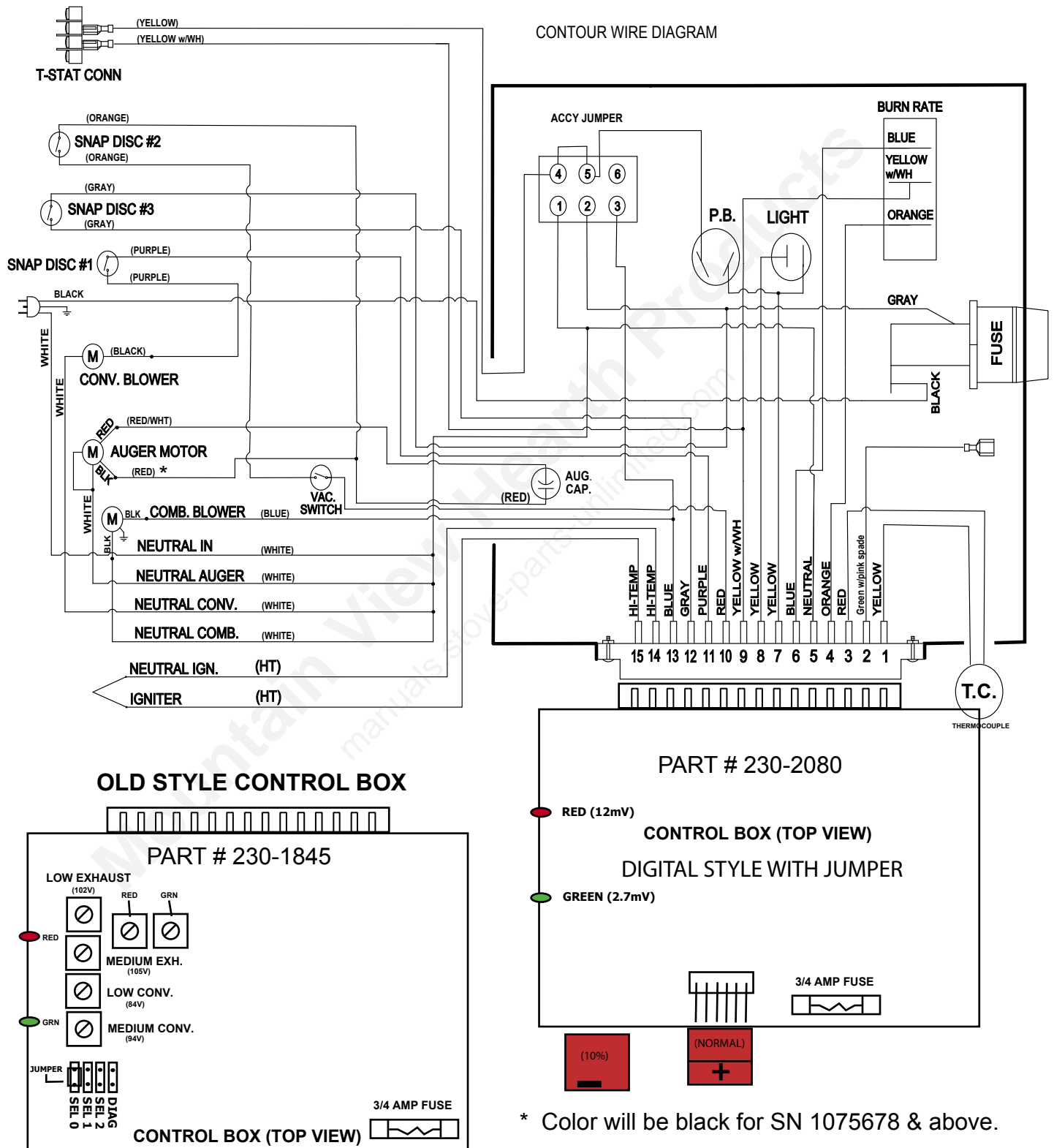

CONTOUR PELLET STOVE SERVICE MANUAL

DIMENSIONS AND SPECS

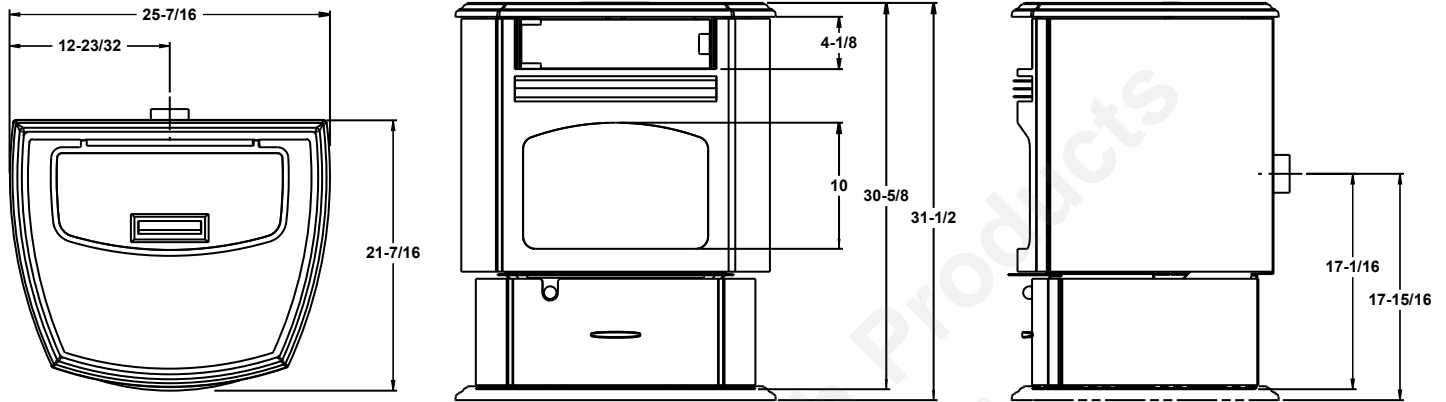

WATTS: 573w TOTAL //// 62w EXHAUST //// 127w CONVECTION //// 380w IGNITER //// 4w FEED MOTOR

AMPS: 4.97A TOTAL //// .54A EXHAUST //// 1.1A CONVECTION //// 3.3A IGNITER //// .03A FEED MOTOR

VOLTS: 115V

VOLTS ON THE MEDIUM FEED SETTING: 105 V (± 3 V) EXHAUST //// 94 V (± 3 V) CONVECTION

VOLTS ON THE LOW FEED SETTING: 102 V (± 3 V) EXHAUST //// 84 V (± 3 V) CONVECTION

NOTE: OPEN CIRCUIT VOLTAGE WILL BE 115 V ON THE HIGH SETTING ONLY

THERMOSTAT CIRCUIT VOLTS: 24 VAC (± 5 V)

NOTE: T-STAT VOLTS ARE MEASURED ACROSS THE THERMOSTAT BLOCK WITH THE T-STAT DISCONNECTED

THERMOCOUPLE MILIVOLTS: 2.7 mV (±.5mV) GREEN LIGHT //// 12.0 mV (± 1 mV) RED LIGHT

BTU: 30,000

VACUUM: .08 to .11" W.C. (WATER COLUMN ON THE HIGH SETTING)

FEED MOTOR "ON" TIMES: .9 sec LOW //// 1.6 sec MEDIUM //// 2.2 sec HIGH

POUNDS PER HOUR BURN RATE: 1.5 lbs. LOW //// 2.5 lbs. MEDIUM //// 3.5 lbs. HIGH

FEED MOTOR RPM: 2

EXHAUST BLOWER CFM: 80

CONVECTION BLOWER CFM: 160

HOPPER CAPACITY: 40 lbs.

CONTOUR PELLET STOVE SERVICE MANUAL



TECH CHECK SHEET



PELLET STOVES

PLEASE ANSWER ALL OF THE QUESTIONS BELOW IF YOU NEED TO CONTACT THE TECHNICAL SERVICES DEPARTMENT. THIS WILL HELP US TO IDENTIFY THE PROBLEM FASTER AND WILL SAVE YOU TIME.

WHAT IS WRONG WITH THE STOVE? _____

MODEL _____ SERIAL NUMBER _____

HOW IS IT INSTALLED? (VERTICAL OR HORIZONTAL) _____

HOW MANY VERTICAL FEET OF VENT? _____ HORIZONTAL? _____

HOW MANY ELBOWS ARE IN THE VENT SYSTEM? _____

WHAT SIZE IS THE EXHAUST PIPE? (3", 4", 6", OR OTHER) _____

WHAT IS THE ELEVATION OF THE HOME? _____

WHAT IS THE FEED ADJUSTMENT PLATE SET AT? _____

IS THE FEED SYSTEM OPERATING? _____

IS THERE POWER TO THE STOVE? _____

IS THERE FUEL IN THE HOPPER? _____

WILL THE THERMOSTAT CALL LIGHT COME ON? _____

IS THE IGNITER WORKING? _____ IS THE EXHAUST BLOWER WORKING? _____

ARE YOU REACHING THE FIRST STAGE OF IGNITION (GREEN LIGHT)? _____

ARE YOU REACHING THE SECOND STAGE OF IGNITION (RED LIGHT)? _____

IS THE CONVECTION BLOWER WORKING? _____

IS THERE AN OUTSIDE AIR KIT INSTALLED? _____

IS THE THERMOSTAT ANTICIPATOR SET AT THE LOWEST SETTING? _____

ARE THE HEAT EXCHANGERS FREE OF ASH AND CLEAN? _____

IS THE VENT SYSTEM CLEAN? _____

IS THE HOPPER FREE OF SAWDUST BUILD UP? _____

IS THE FIREPOT CLEAN? _____

TECH/WARRANTY DEPARTMENT: PHONE--#509-684-3745 OR #800-234-2508

FAX: #877-613-3097

CONTOUR PELLET STOVE SERVICE MANUAL

CLEANING & MAINTENANCE TIPS

CAUTION: REMEMBER TO UNPLUG THE STOVE BEFORE PERFORMING ANY CLEANING OR MAINTENANCE ON THE STOVE.

CLEANING OR INSPECTION	DAILY	WEEKLY	MONTHLY	YEARLY
FIREPOT USING WOOD PELLETS: EVERY 3 BAGS OR		X		
FIREPOT USING SHELLED CORN: EVERY BAG OR	X			
FIREBOX ASH REMOVAL: AS NEEDED OR		X		
HEAT EXCHANGER CLEANING: AS NEEDED OR			X	
VENT / CHIMNEY SYSTEM: EVERY 2 TONS OF FUEL OR				X
CONVECTION BLOWER: EVERY 3 TONS OF FUEL OR				X
EXHAUST BLOWER: EVERY 2 TONS OF FUEL OR				X
GLASS DOOR: EVERY 5 BAGS OF FUEL OR		X		

CONTOUR PELLET STOVE SERVICE MANUAL

CLEANING & MAINTENANCE TIPS

FIREPOT:

THE FIREPOT NEEDS TO BE CLEANED AS NEEDED. THE BUILD-UP OF CLINKER MATERIAL WILL DEPEND ON THE QUALITY OF THE FUEL BEING USED. IN SOME CASES, IT MAY BE NECESSARY TO CLEAN THE FIREPOT ON A DAILY BASIS.

FIREPOT CLEANING INVOLVES SIMPLY PULLING THE CLEANOUT ROD ON THE FRONT OF THE STOVE. IF THE ROD IS HARD TO PULL, IT MAY BE NECESSARY TO USE THE SCRAPER OR SCREW DRIVER TO CHIP AWAY THE CARBON MATERIAL THAT HAS BUILT UP ON THE BOTTOM PLATE OF THE FIREPOT. ONCE THE DEBRIS IS CHIPPED AWAY, THE ROD WILL BE EASY TO PULL.

FIREBOX ASH:

THE FIREBOX ASH SHOULD BE REMOVED AT THE SAME TIME THAT THE FIREPOT IS CLEANED. FREQUENT CLEANING OF THE ASH IN THE FIREBOX WILL HELP SLOW DOWN THE BUILD-UP OF ASH IN THE EXHAUST BLOWER AND VENT SYSTEM. REMEMBER TO DEPOSIT ASHES IN A NONCOMBUSTIBLE CONTAINER.

HEAT EXCHANGER:

THE HEAT EXCHANGERS CAN BE CLEANED BY PULLING THE 2 RODS LOCATED UNDER THE TOP LID OF THE STOVE. THE RODS SHOULD BE PULLED EACH TIME THE FIREPOT IS CLEANED. A MORE THOROUGH CLEANING WILL BE NEEDED AT LEAST ONCE A MONTH. THIS WILL INCLUDE REMOVING THE BAFFLE PLATE IN THE FIREBOX AND CAST IRON FIREBOX COVERS. THIS IS NECESSARY TO REMOVE THE EXCESS ASH THAT IS LEFT BEHIND FROM THE USE OF THE PULL RODS FOR THE HEAT EXCHANGER TUBES.

VENT / CHIMNEY SYSTEM:

THIS NEEDS TO BE CLEANED AND INSPECTED AT LEAST ONCE A YEAR. IT MAY BE NECESSARY TO PERFORM MORE FREQUENT CLEANING IF THERE IS A LOT OF HORIZONTAL PIPE SECTIONS. ASH WILL BUILD UP MORE QUICKLY IN THE HORIZONTAL SECTIONS.

BLOWERS:

THE BLOWERS MAY ONLY NEED TO BE CLEANED ONCE A YEAR. IF THE USE OF THE STOVE IS HEAVY, THEN IT MAY NEED TO BE DONE MORE FREQUENTLY. IF THE BLOWER IS GETTING NOISY, THEN THE FAN BLADES WILL NEED TO BE CLEANED.

CONTOUR PELLET STOVE SERVICE MANUAL

RECOMMENDED SERVICE TOOLS

- 1) DIGITAL VOLTMETER-----FOR CHECKING VOLTS AND CONTINUITY OF CIRCUITS
- 2) DIGITAL MANOMETER-----FOR CHECKING VACUUM IN THE FIREBOX
- 3) TEST CORD-----FOR CHECKING INDIVIDUAL COMPONENTS
- 4) TEST BOX-----FOR CHECKING THE WIRE HARNESS & COMPONENTS



DIGITAL VOLTMETER

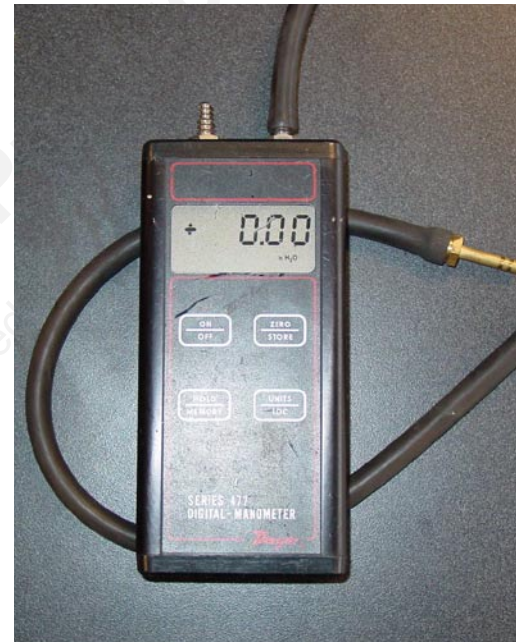

DIGITAL MANOMETER

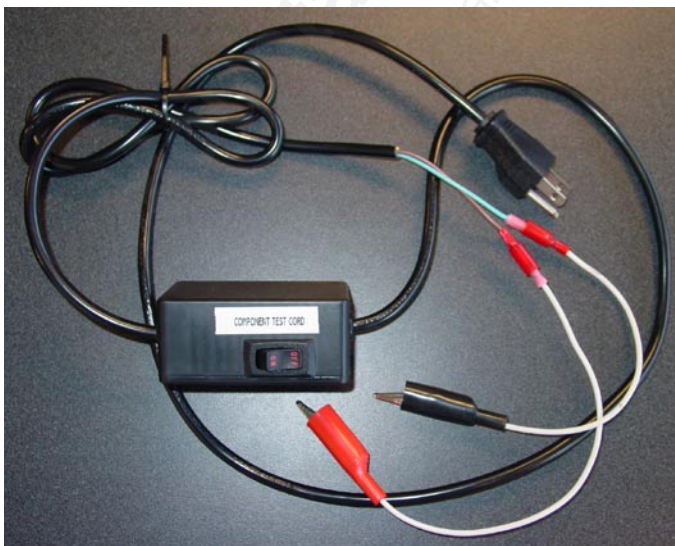

COMPONENT TEST CORD



TEST BOX

CONTOUR PELLET STOVE SERVICE MANUAL

Mountain View Hearth Products
manuals.stove-parts-unlimited.com