

QUADRA-FIRE®

User's Manual

WALL CONTROL

Part SRV7000-451

Mt. Vernon Pellet Appliances (AE)

EDGE™ 60 Pellet Fireplace

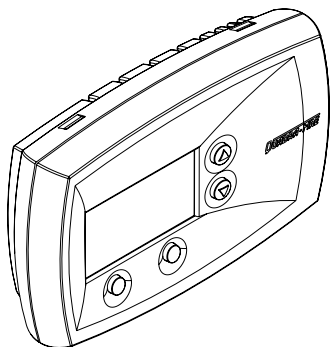

Tested and
Listed by  Portland
Oregon U
C US
OMNI-Test Laboratories, Inc.

NOTICE



DO NOT DISCARD THIS MANUAL

- Important operating and maintenance instructions included.
- Read, understand and follow these instructions for safe installation and operation.
- Leave this manual with party responsible for use and operation.



CAUTION

Check building codes prior to installation.

- Installation MUST comply with local, regional, state and national codes and regulations.
- Consult local building, fire officials or authorities having jurisdiction about restrictions, installation inspection, and permits.

CONTACT INFORMATION:

Hearth & Home Technologies
1445 North Highway, Colville, WA 99114
Division of HNI INDUSTRIES

Please contact your Quadra-Fire dealer with any questions or concerns. For the number of your nearest Quadra-Fire dealer log on to www.quadrafire.com

TABLE OF CONTENTS

A. Introduction	2
B. Main Screen	
1. System Status Codes	2
2. Current Time	2
3. Set Temperature	2
4. Notification Icons	2
5. Function Buttons	3
6. Current Temperature	3
C. General Information about using the Wall Control	3

D. Main Menu	
1. Set Comfort Level (Temperature)	3
2. Auto/Manual/Off	4
3. Fuel Type	4
4. Programming	5
5. Set Day/Time	4
6. User Settings	6-7
E. Quick Start Guide	8-9
F. Service Information	10
G. Error Codes	10
H. Battery Back-up (Optional)	10
I. Troubleshooting Guide	11

A. Introduction

Welcome to the Quadra-Fire family. This manual will help you understand and operate the wall control attached to your new pellet Advanced Energy appliance.

The Quadra-Fire Wall Control is not just a traditional thermostat, but an integral part of the pellet appliance system. While it has many of the features one would expect from an advanced thermostat, including programmable setback capabilities and current temperature display, it also indicates the system's current operating cycle and state. It does this by communicating with the appliance via a wired connection.

Additionally, it allows you to set parameters that will optimize the performance of your pellet appliance system. These parameters are accessed with an easy to navigate menu system.

B. The Main Screen

The key to being comfortable while operating your new wall control is to familiarize yourself with the main screen. The main screen shows, at a glance, the status of the system, the most important settings and the current temperature. Additionally, the main screen indicates with simple icons many user actions required to keep your appliance working as intended. **Figure 2.1.**

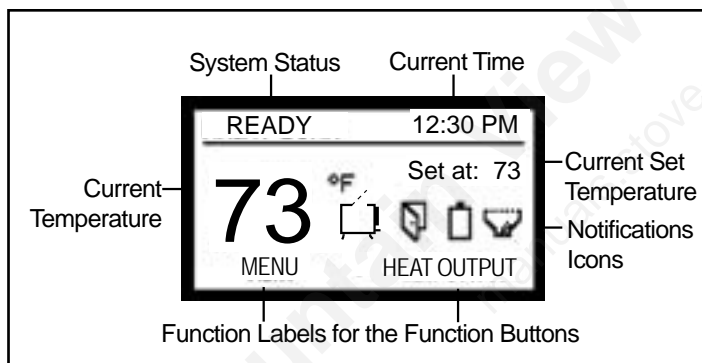

Figure 2.1

1. System Status Codes

The status area is used to indicate the current status of the system. It indicates if the system is running in automatic or manual cycle, if it is turned on or off and where it is in the operating sequence.

a. START-UP

Indicates that the appliance is in start-up cycle and is in the process of lighting an initial charge of fuel.

b. SS-LOW or SS-MED (SS = soft start)

Indicates the soft-start portion of the lighting sequence. In these stages the fire begins to gradually build to operating temperature.

c. AUTO: (x) or MAN: (x) (x) = heat output level

Indicates both the operating cycle (automatic or manual) and the current heat output level. The heat output level will be "H" high, "MH" medium high, "M" medium, "ML" medium low and "L" low.

d. READY

Indicates that the system is turned on and is functioning normally, but there is no call for heat (the room temperature is not below the set temperature). **See Figure 7.1 on page 7.**

e. SHUTDOWN

Indicates the system is shutting down, either because it is no longer calling for heat or the maximum burn time has been reached and the system must run an auto-clean cycle.

f. AUTO-CLEAN

Indicates the system is running the firepot auto-clean cycle.

g. OFF

Indicates the system has been shut down by the user.

h. MAINT BURN (Battery Back-up Only)

The maintenance burn is to keep the system from shutting down when operating on battery backup. The appliance will not automatically re-light in manual mode.

2. Current Time

Indicates the current time. The time is used for the programmable setback features of the wall control.

3. Set Temperature

Indicates the current set temperature. It will change automatically as the control progresses through the 7 day setback program. If the wall control is in HOLD TEMP cycle the "Set at:" indication will change to "Hold at:" and displays the operating temperature setting.

4. Notification Icons

The system notification area uses icons to indicate if an action needs to be taken. In battery mode it indicates the approximate charge level of the battery.

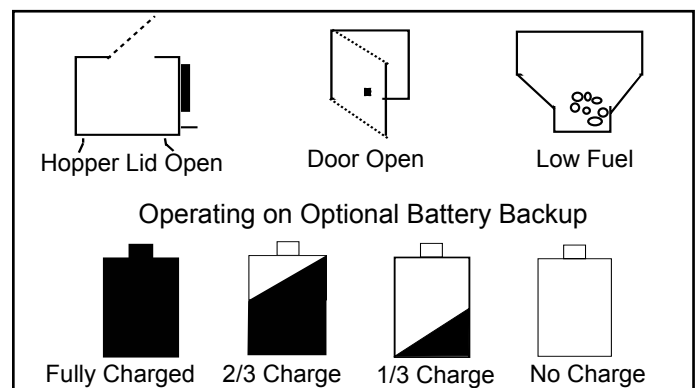

Figure 2.2

5. Function Buttons

The function buttons have two labels above them in the display area. Their labels can change depending on the menu screen. On the main screen the left button will bring up the system menu and the right button has functionality only in MANUAL cycle. **Figure 3.2.**

6. Current Temperature

The current temperature area indicates the temperature of the room where the wall control is located. The temperature displayed can be in units of Fahrenheit or Celsius. The desired units can be selected via the system menu. **See Figure 6.5 on page 6.**

C. General Information About Using the Wall Control

When a button is pressed and the screen changes from the main screen to one of the other screens, the backlight will illuminate the display area. As buttons are pressed, the backlight continues to be illuminated.

Most screens have a DONE button which can be used to return to the previous screen ultimately returning to the main screen.

The wall control will automatically revert back to the starting screen if there is no activity for 15 seconds except for the CONFIRM FUEL CHANGE screen. The main screen will be illuminated for an additional 10 seconds and the backlight will shut off.

If the wall control is subjected to a static shock, the screen may go blank. If this happens, wait 25 seconds and press any button. This will reset the screen restore functionality and turn on the back light. If this does not work, call your dealer.

D. The Main Menu

The menu is the heart of customizing the operation of the pellet appliance system to your personal liking. The choices on this menu are:

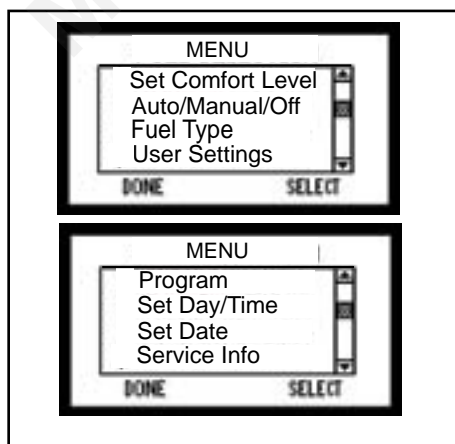

Figure 3.1

1. Set Comfort Level (Temperature)

The most basic operation of the wall control is to turn the appliance on or off depending on the requirement for heat. From the main screen, the SET COMFORT LEVEL screen can be activated by pressing the UP or DOWN button on the right side of the display area.

The first time either button is pressed the display changes to the SET COMFORT LEVEL screen and shows the current set temperature. Subsequent presses or holding the UP or DOWN button will change the set temperature. **Figure 3.2.**

You can override the programming either permanently or temporarily. The HOLD TEMP button (lower right) on the SET COMFORT LEVEL screen is used to override preset programming. **Figure 3.3.** By pressing the HOLD TEMP button, the current set temperature will permanently override any programmed temperature in the 7 day setback programming. This is a convenient way of overriding a program when your schedule changes temporarily and you don't want to reprogram the setback functions on the wall control.

To release the permanent override, press the button labeled RESUME when in the HOLD TEMP cycle. Pressing the button again will resume the programming at the next program interval. **Figure 3.4.**

To temporarily override the programming, use the UP and DOWN buttons only and do not press the HOLD TEMP button. The display will show how long the new temperature will hold before it returns to the next scheduled programming. **Figure 3.3.**

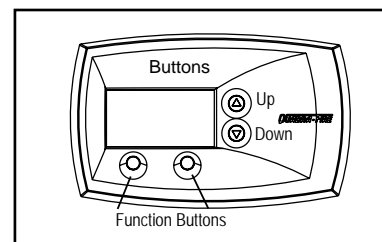

Figure 3.2



Figure 3.3

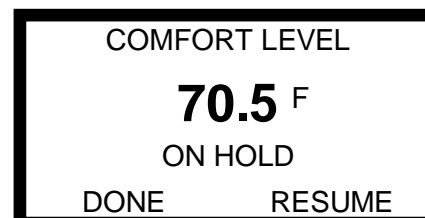

Figure 3.4

2. Auto / Manual / Off Selection

a. Automatic

In the AUTOMATIC cycle the wall control will turn the appliance on and off automatically and also turns the heat output level up or down depending on the temperature setting. The further away the room temperature is from the set temperature, the higher the heat output.

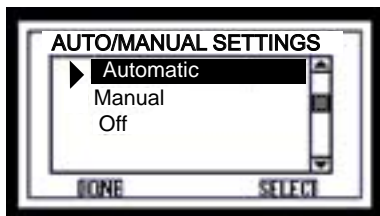

Figure 4.1

b. Manual

In MANUAL cycle, the heat output remains the same regardless of the difference between the set and room temperatures. The wall control will function as a simple on/off thermostat. When the system is set to MANUAL the HEAT OUTPUT selection is added in the lower right corner.

Press the button under this selection to access this feature. The HEAT OUTPUT screen is used to set the level of heat produced whenever the wall control calls for heat. **Figure 4.3.** The HEAT OUTPUT screen is not accessible in AUTOMATIC cycle.

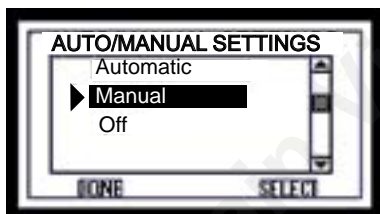

Figure 4.2

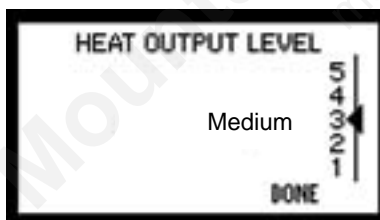

Figure 4.3

c. OFF

This selection turns the appliance off. When the appliance is set to OFF, it will not light regardless of room temperature. Use this setting when cleaning and maintaining your appliance.

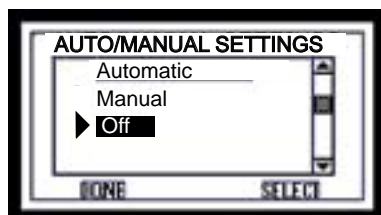

Figure 4.4

3. Fuel Type

The FUEL TYPE screen is used to select the fuel that will be used with the pellet system. The list on this screen indicates all fuel choices available to burn in the appliance.

NOTE: The list of fuels can be updated by your local dealer as they become available.

To select a fuel type, use the UP/DOWN buttons to scroll to the desired fuel type and then press the button under "Select". The arrow will change to indicate the currently selected fuel.

NOTE: If you are burning a high ash fuel set the fuel selection to "Utility Pellets".

When purchasing corn or wheat to burn in your appliance, read the ingredient label very carefully. **Do NOT purchase fuel that contains any additives** such as oils (i.e. soybean oil) and meals as it will result in poor appliance performance. If you are buying corn or wheat the only ingredient that should be listed is corn or wheat.

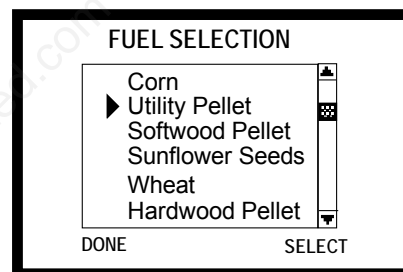

Figure 4.5

4. Program (7 Day Programming)

The wall control is pre-programmed at 68°F for all time settings. It will remain there until it is re-programmed.

The wall control can be programmed as a setback thermostat. Each day of the week has four program periods. The wall control menus have some features that make it easy to program groups of days alike. This minimizes the number of steps required to program the wall control for most applications.

To access the programming screen, select Program from the menu screen and then select the desired programming range from the PROGRAMMING RANGE screen.

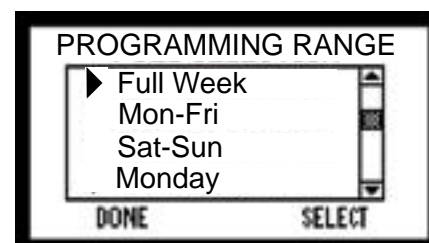

Figure 4.6

a. Full Week

NOTE: It is important to note that the most recent programming entry will override all previous programming for an individual day or range of days.

The small triangle on the left side indicates the current active programming line. **Figure 4.6 on page 4.** For each of the four intervals available to program there are three adjustable values: set hour, set minutes and set temperature. You will need to increase or decrease the hour to change from AM to PM.

When the screen is first entered the "Wake Hour" is highlighted. Use the UP/DOWN buttons to adjust the hour to the desired hour and press the button under "Set/Next". The highlight will move to the minutes display. Adjust the minutes and press "Set/Next." The highlight is now on the temperature value. Set the desired temperature for the Wake period and press "Set/Next."

The highlight is now on the hour display for the Day period, and the triangle has moved to the second line. Continue programming each value as desired. (To store the final value be sure to press "Set/Next" to return the highlight to the first value on the screen.)

When you are finished making changes, or if you just entered the programming screen to view the set program, press "Done" or let the display return to the main screen automatically.

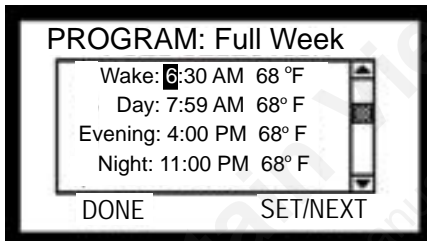

Figure 5.1

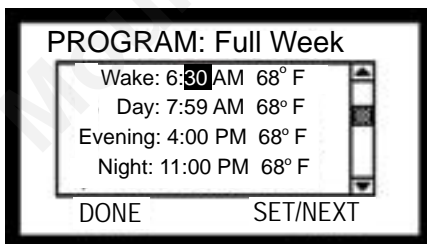

Figure 5.2

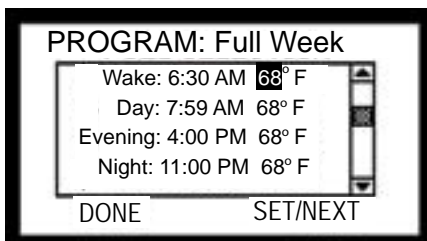

Figure 5.3

5. Set Day/time

a. Set Day/Time

In order for the setback function to work properly the wall control must be aware of the current time. The SET DAY/TIME screen is used to set the system clock. When the screen is entered the day of the week is highlighted.

Use the UP/DOWN buttons to change this to the current day of the week. Press the button under "Set/Next" and the highlight will be moved to the current hour field. Again, use the UP/DOWN buttons to set this to the current hour. Press the "Set/Next" button again and the current minute display is highlighted.

Use the UP/DOWN buttons to adjust to the correct minutes and press "Set/Next" one last time. The highlight will move back to the original day of week display.



Figure 5.4



Figure 5.5



Figure 5.6

b. Set Date

When the SET DATE screen is entered the month name is highlighted. Use the UP/DOWN buttons to select the proper month then press the button under "Set/Next."

The highlight will move to the day of the month display. Using the UP/DOWN buttons, select the current date then press "Set/Next." The highlight will move to the year display. Select the current year and press "Set/Next" then the highlight will be back on the month name display.



Figure 6.1



Figure 6.2



Figure 6.3

6. User Settings

Items that are rarely changed are stored under the USER SETTINGS.

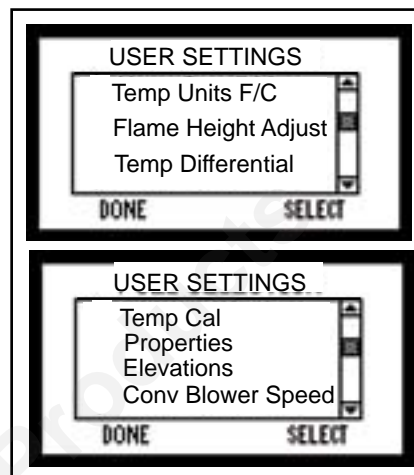

Figure 6.4

a. Temp Units F/C

The TEMP UNITS screen is used to change from Fahrenheit to Celsius and back for the temperatures displayed.

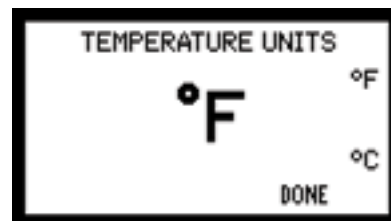

Figure 6.5

b. Flame Height Adjust

The FLAME HEIGHT ADJUST screen is used to adjust the flame height (fuel feed rate) for specific installation and fuel type. The dealer will usually adjust this if necessary on installation and can advise on specific settings for a particular application.

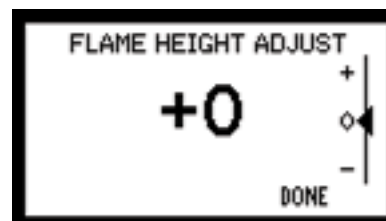

Figure 6.6

c. Temp Differential

The TEMPERATURE DIFFERENTIAL screen is used to change the set default temperature differential. This sets how far below the set point the wall control allows the room temperature to fall before the appliance turns back on. It is usually set at time of installation.



Figure 7.1

d. Temperature Calibration

The TEMPERATURE CAL screen is used to calibrate the temperature on the wall control. If for some reason you feel the wall control is not accurately reading the temperature you can calibrate it to a thermostat that you know is accurate. Press the UP/DOWN buttons to the desired temperature.

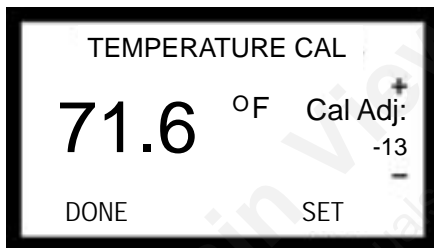

Figure 7.2

e. Properties

The PROPERTIES screen shows the version of software for the control board and wall control. If you are placing a service call with your dealer, they may ask you to go to this screen and read them the information under "WC" and "SC".

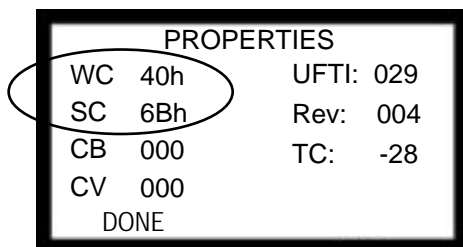

Figure 7.3

f. Elevation

The ELEVATION screen allows you to adjust the appliance to your specific elevation. Press the UP/DOWN buttons to select your elevation. The message in the center will change between NORMAL and HIGH. If you select HIGH, it will replace the normal fuel tables with specific high fuel tables. You **MUST** select a fuel type after selecting HIGH.

Please note that changing the elevation will delete any custom or new fuel table loaded into the appliance. You must confirm your choice on the CONFIRM ELEVATION CHANGE screen. This allows you to reverse your decision if necessary. **Figure 7.5.**

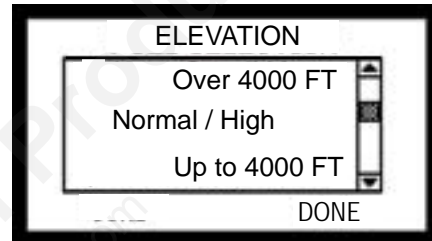

Figure 7.4

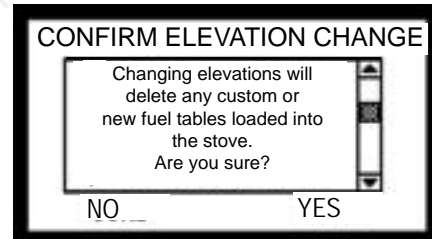

Figure 7.5

g. Convection Blower Speed

The CONV BLOWER SPEED screen allows you to adjust the blower speed to your individual preference. Press the UP/DOWN buttons to select your blower speed. The message in the center will change between NORMAL and QUIET.

NORMAL allows the convection blower to reach maximum RPM at 135 degrees and QUIET at 165 degrees.

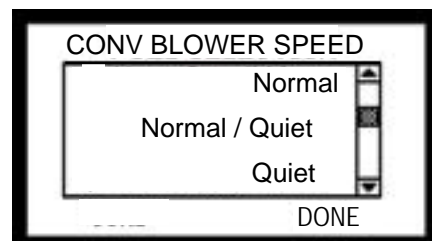
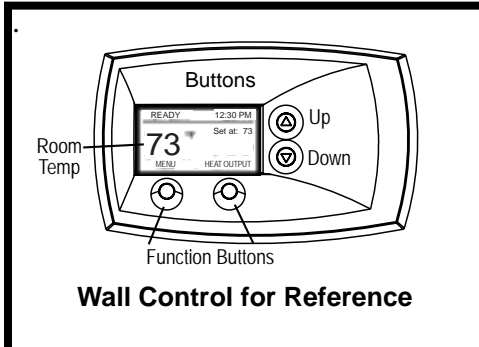

Figure 7.6

E. Quick Start Guide

NOTICE: Any button pressed will turn on the backlight. The wall control will automatically revert back to the starting screen if there is no activity for 15 seconds; except for the “CONFIRM FUEL CHANGE” screen.



Wall Control for Reference

TURNING ON APPLIANCE



1. At the starting screen, press “MENU”.

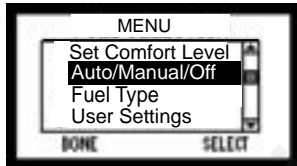

2. Highlight “AUTO/MANUAL/OFF”. Press “SELECT”.

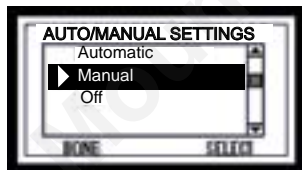

3. Highlight “MANUAL”. Press “SELECT”.
4. Press “DONE” twice or wait 15 seconds for starting screen to re-appear.

CHOOSING FUEL TYPE



1. At the starting screen, press “MENU” button once or twice until “MENU” screen appears.

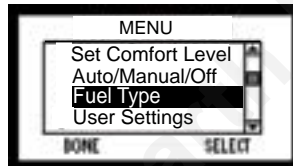

2. Highlight “FUEL TYPE” using the “UP/DOWN” buttons to the right side of the display. Press “SELECT”.

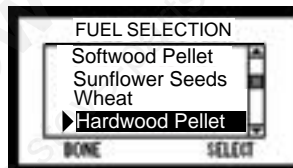

3. Scroll down and highlight “HARDWOOD PELLETT” or your fuel type.
4. Now press “SELECT” to choose new fuel.

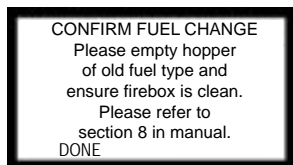

5. Press “DONE” to confirm fuel change.
6. Press “DONE” twice or wait 15 seconds for starting screen to re-appear.
7. Fill the hopper with fuel. If the hopper was completely empty or has run out of fuel, put approximately 1/2 cup of pellets into the firepot for a quick restart.
8. Be sure the hopper lid and glass door are both closed.

CHOOSING TEMP UNIT: °F or °C



1. At the starting screen, press “MENU” button once or twice until “MENU” screen appears.

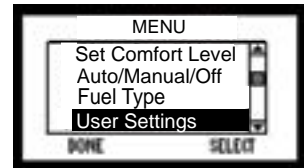

2. Highlight “USER SETTINGS” using the “UP/DOWN” buttons to the right side of the display. Press “SELECT”.

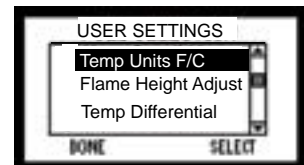

3. Highlight “TEMP UNITS F/C” using the “UP/DOWN” buttons to the right side of the display. Press “SELECT”.

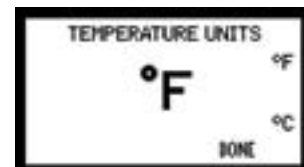

4. Press the “UP” or “DOWN” button to set desired temperature unit and press “SELECT”..
5. Press “DONE” twice, or wait 15 seconds for starting screen to re-appear.

E. Quick Start Guide (Cont'd)

SETTING COMFORT LEVEL



1. Press and hold "UP" or "DOWN" button to set desired temperature.

NOTE: Set temperature must be 3 degrees higher than room temperature for appliance to start.



2. Press "HOLD TEMP".



3. Press "DONE".

SETTING HEAT OUTPUT



1. At the starting screen, press "HEAT OUTPUT".



2. Use the "UP" button to change "HEAT OUTPUT LEVEL" to "MEDIUM-HIGH".
3. Press "DONE" twice or wait 15 seconds for starting screen to re-appear.

HOPPER OUT OF FUEL

ERROR LIST



RETRY SERVICE

1. If the appliance has stopped operating, check the wall control screen. If it is showing "Min Firepot Temp" the hopper has run out of fuel.
2. Fill the hopper with fuel and press the "RETRY" button twice. The first time turns on the back light, the second time starts the retry function.



3. If the wall control screen changes to a "SHUTDOWN" screen that means your appliance has not completed the full shutdown cycle. Depending on where it was in the cycle it can take from one to ten minutes to restart.

When the shutdown cycle is complete the wall control screen will display "STARTUP". Continue to Step 4.



4. If the wall control screen changes to a "STARTUP" screen after pressing "RETRY" that means your appliance has already completed the shutdown cycle. You must wait until the wall control screen displays the startup screen and then put 1/2 cup of pellets in the firepot for a quick restart.
5. Be sure the hopper lid and glass door are both closed.

F. Service Information

The SERVICE INFORMATION screen displays contact information for Hearth & Home Technologies Customer Service Line. The local dealer may have changed this upon or before the installation to indicate a dealer hot line.



Figure 10.1

G. Error Codes

If a system error occurs that forces the system to stop operating an error screen appears. Depending upon the error type, up to three retry attempts are allowed after which a service professional is required.

Press the ERROR LIST button to display the latest error. **Figure 10.1.** See page 11 for a list of error codes.

H. Battery Back-up System (Optional)

The appliance has been designed to operate on an optional battery back-up system.

If you have frequent power outages in your region, hook the appliance up to a 12 volt battery and it will automatically switch to battery power in the event of a power failure. The 12 volt power cord sold as a separate accessory does not charge the battery.

Refer to the Owner's Manual for your appliance for instructions on how to attach the cable to your appliance. The following are the screens you will see when using a back-up battery.

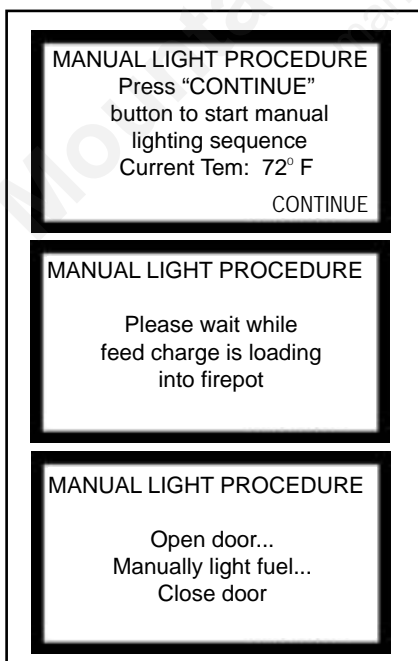

Figure 10.2

Operating on Battery Back-Up

- A battery icon appears on your wall control to let you know you are now operating on battery power. **Figure 10.3.**
- The fire must be manually lit as the appliance will no longer automatically light. **See page 4.**
- Use only approved fire starting gel to start the fire.
- The high burn rate is no longer available on battery back-up.
- Each level drops down one level, i.e the high burn becomes medium-high burn and so on.
- If the battery charge falls below 10 volt it can no longer sustain the appliance operation and the appliance will shut down. You must disconnect and reconnect the battery to start it up again.

Recommended Battery

- 12 volt deep cycle battery, (i.e., marine or RV type).
- A 12 volt battery cable is available through your local dealer.

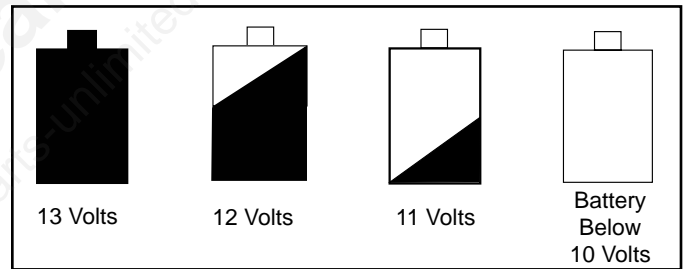

Figure 10.3

Wall Control Display

The wall control will display the battery icon when operating in the battery back-up mode. **Figure 10.4.**

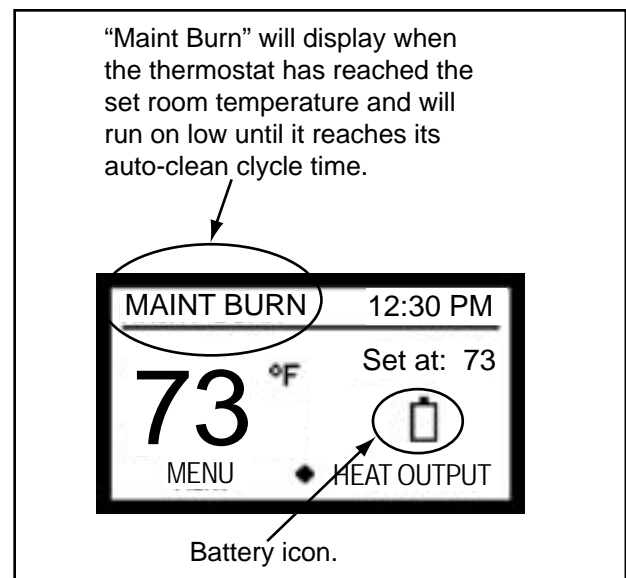

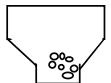

Figure 10.4

I. TROUBLESHOOTING

With proper installation, operation, and maintenance your appliance will provide years of trouble-free service. If you do experience a problem, this troubleshooting guide will assist a qualified service person in the diagnosis of a problem and the corrective action to be taken.

NOTE: This troubleshooting guide should only be used by a qualified service technician.

Error Message	Possible Cause	Corrective Action
— — — —	Bad wall control or control board 3 wires have loose connections or installed wrong	Replace wall control or control board Check connections
BAD TC DROP TUBE <i>TC = Thermocouple</i>	Drop tube thermocouple is broken or leads are reversed	Check connections Replace thermocouple
BAD TC FIREPOT <i>TC = Thermocouple</i>	Firepot thermocouple is broken or leads are reversed	Check connections Replace thermocouple
SNAP DISC TRIPPED	Overheat sensor (snap disc) has tripped Convection blower may need cleaning	If have power switch, turn off, manually reset the snap disc & turn power back on. If no power switch, unplug appliance Clean convection blower if needed.
VACUUM SW ERROR <i>SW = Switch</i>	Vacuum switch is bad Vacuum hose is plugged/disconnected	Check connections. By-pass vacuum with jumper wire, if run, switch is bad. Replace switch. Check vacuum hose
COMB BLOWER JAMMED	Combustion blower is blocked/jammed	Remove blockage Replace blower if necessary If have power switch, turn off & turn back on to clear error. If not unplug the appliance.
AUGER JAMMED	Auger jammed, feed motor bad	Pull the feed system and inspect Clear jam and then press Retry button
MISSED IGNITION	Igniter bad or poor harness connection Out of fuel or fuel is bridging in hopper Faulty firepot thermocouple, connection is shorted	Check connections, if OK replace igniter Break up bridging pellets. Refill hopper Replace the thermocouple & press Retry
MIN FIREPOT TEMP	Out of fuel	Refill hopper Add handful of pellets to the firepot to prime it Press the Retry button
MAX DROP TUBE TEMP	Stove in over-heat condition Wrong fuel table setting Flame height set too high Components may need cleaning	Confirm setting matches burning fuel Adjust flame height Clean the firebox, heat exchanger, convection blower, firepot and ash pan
CONV BLOWER JAMMED	Convection blower blocked/jammed	Remove blockage Replace blower if necessary If have power switch, turn off & turn back on to clear error. If not unplug the appliance.
CHECK ASHPAN	Auto-clean jammed Auto-clean switch is bad Linkage has become disconnected	If ash pan is empty, check for a jam. Use a screw driver and firmly push in the firepot floor holes and flex spring and push toward home to release jam. Replace switch Reconnect linkage.
SCREEN GOES BLANK	Static discharge or nearby lightening or Electric Fast Transients at the input mains	If have power switch, turn off & turn back on to refresh the screen. If not unplug the appliance.
	Hopper lid not closed all the way Switch is out of adjustment (auger will not function)	Close the lid. If that didn't work replae the switch Adjust or replace switch
	Firebox door is not latched properly Fireplace not rolled in completely	Adjust or replace door switch Adjust or replace interlock switch
	Out of fuel	Check the latch, if OK, replace switch

QUADRA-FIRE®

CONTACT INFORMATION:

Hearth & Home Technologies
1445 North Highway
Colville, WA 99114
Division of HNI INDUSTRIES

Please contact your Quadra-Fire dealer with any questions or concerns.
For the number of your nearest Quadra-Fire dealer
visit our web site at www.quadrafire.com

NOTICE



DO NOT DISCARD THIS MANUAL

- Important operating and maintenance instructions included.
- Read, understand and follow these instructions for safe installation and operation.
- Leave this manual with party responsible for use and operation.

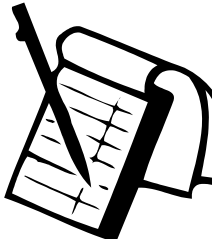

We recommend that you record the following pertinent information for your appliance.

Date purchased/installed: _____

Serial Number: _____ Location on appliance: _____

Dealership purchased from: _____ Dealer phone: _____

Notes: _____

This product may be covered by one or more of the following patents: (United States) 4593510, 4686807, 4766876, 4793322, 4811534, 5000162, 5016609, 5076254, 5113843, 5191877, 5218953, 5263471, 5328356, 5341794, 5347983, 5429495, 5452708, 5542407, 5601073, 5613487, 5647340, 5688568, 5762062, 5775408, 5890485, 5931661, 5941237, 5947112, 5996575, 6006743, 6019099, 6048195, 6053165, 6145502, 6170481, 6237588, 6296474, 6374822, 6413079, 6439226, 6484712, 6543698, 6550687, 6601579, 6672860, 6688302B2, 6715724B2, 6729551, 6736133, 6748940, 6748942, 6769426, 6774802, 6796302, 6840261, 6848441, 6863064, 6866205, 6869278, 6875012, 6880275, 6908039, 6919884, D320652, D445174, D462436; (Canada) 1297749, 2195264, 2225408, 2313972; (Australia) 780250, 780403, 1418504 or other U.S. and foreign patents pending.

