

OE Technology

Contour, CB 1200-I
Castile Stove & Insert
Santa Fe Stove & Insert
Mt. Vernon Stove

QUADRA-FIRE®

Pellet Igniter Replacement Part #SRV7000-462

AE Technology

Mt. Vernon AE Stove
Mt Vernon AE Insert
EDGE 60 Fireplace

OE TECHNOLOGY MODELS

Included in Kit: (1) loop igniter (heating element),
(1) thumb screw

Tools Required: Phillips screwdriver

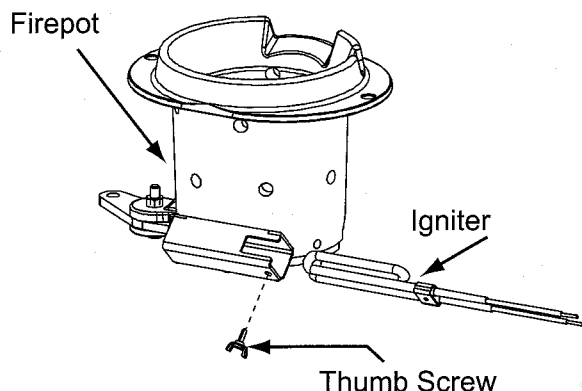

MODEL SPECIFIC

CONTOUR STOVE

Remove the bottom ash drawer. Using a Phillips screw driver, remove the 2 screws that secure the firepot guard located just underneath the ash catcher in front of the firepot. With the guard removed, the ignition chamber on the firepot and the wiring are now exposed.

CASTILE & MT. VERNON STOVE

Swing open ash door and remove ash pan.

SANTA FE STOVE & INSERT

Pull out ash drawer. On the insert when pulling up excess wire in step 4, push the excess wire leads back through the grommet one wire at a time.

1200-I INSERT

Open the clean-out door with a slight pull up and out and remove the ash pan.

CASTILE INSERT

Open the front cast door and remove the ash pan.

NOTE: On older appliances that use ceramic nuts with 6 inch lead wires on the igniter, cut down the 18 inch lead wires on the new igniter to 6 inches. Strip back the insulation about 1/2 inch and secure with the ceramic nuts by turning clockwise.

PROPER SHUTDOWN PROCEDURE



CAUTION

Shock and Smoke Hazard

- Turn down thermostat, let appliance completely cool and exhaust blower must be off. Now you can unplug appliance before servicing.
- Smoke spillage into room can occur if appliance is not cool before unplugging.
- Risk of shock if appliance not unplugged before servicing appliance.

GENERAL INSTRUCTIONS

1. Follow proper shutdown procedures above.
2. To access the igniter you will need to remove the ash drawer/pan first. Locate your model to the left for specific instructions.

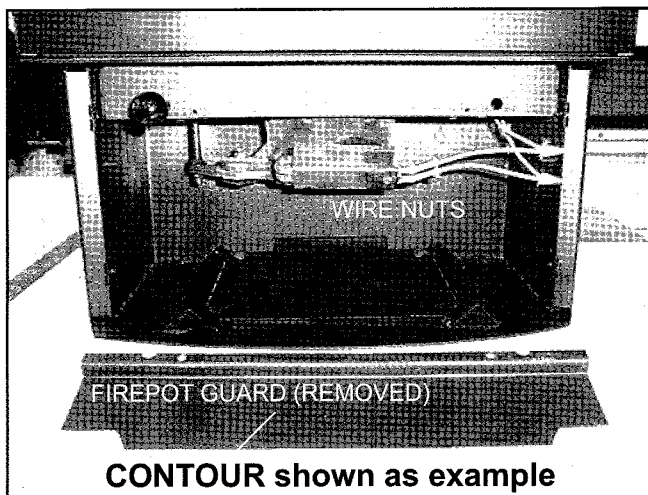

3. The wire leads to the igniter are connected to the wire harness with 1/4 inch male / female spade connectors. These wires will pull forward approximately 4 to 5 inches (102 to 127mm). Disconnect the spade connectors and remove the igniter from the chamber. Loosen the thumb screw and slide igniter out.

OF TECHNOLOGY MODELS (Cont'd)

4. Install new igniter into the chamber and tighten the thumb screw. Re-connect the wires to the 2 leads with the spade connectors.
5. Remove right side panel (if necessary) and pull wire leads back toward the rear of the appliance to take-up the 4 to 5 inches (102 to 127mm) previously pulled out. This will keep the wires out of the way of the ash drawer/pan. Double check that the igniter wires are clear of any movement, i.e. ash drawer/pan, firepot cleaning rod, etc.
6. Re-install the ash drawer/pan and side panel (if removed) and re-connect the power.

CB1200-I INSTRUCTIONS

PROPER SHUTDOWN PROCEDURE



CAUTION

Shock and Smoke Hazard

- Turn down thermostat, let appliance completely cool and exhaust blower must be off. Now you can unplug appliance before servicing.
- Smoke spillage into room can occur if appliance is not cool before unplugging.
- Risk of shock if appliance not unplugged before servicing appliance.



CB1200-I

NOTE: On older appliances that use ceramic nuts with 6 inch lead wires on the igniter, cut down the 18 inch lead wires on the new igniter to 6 inches. Strip back the insulation about 1/2 inch and secure with the ceramic nuts by turning clockwise.

1. Open the front access door, and remove the ash pan. The ignition chamber on the firepot and the wiring are now exposed. The wires are connected together with two ceramic wire nuts. These wires will pull forward approximately four to five inches.
2. Holding the wires, turn the wire nut counter-clockwise to remove the wire nuts.
3. With wire nuts removed and wires separated, remove the igniter from the chamber. Using the Phillips screwdriver, remove the single screw and slide the igniter out.
4. Install the new igniter into the chamber.
5. Re-connect the wires to the two leads in any order.
6. Re-install the ceramic wire nuts by turning clockwise.
7. Open the right side curtain and pull the wire leads back toward the rear of the stove to take up the four to five inches pulled out previously to keep the wires out of the way. Operate firepot cleaning rod, while watching for any interference with the wires (adjust wire location if necessary).
8. Re-install ash pan, close access door, and reconnect to power.

AE TECHNOLOGY MODELS

Included in Kit: (1) loop igniter (heating element),
(1) washer 1/4 (1) wing nut 8-32x12

Tools Required: Phillips screwdriver

PROPER SHUTDOWN PROCEDURE



CAUTION

Shock and Smoke Hazard

- Set wall control to OFF on AUTOMATIC / MANUAL SETTING screen.
- Wall control screen will scroll through the following messages after setting to OFF.
 1. Shutdown
 2. Auto-Clean
 3. Off
- Smoke spillage into the room can occur if the appliance is not cool before unplugging.
- There is a risk of shock if the appliance is not unplugged before servicing the appliance.
- After servicing, restart with the AUTO/MANUAL SETTINGS screen.

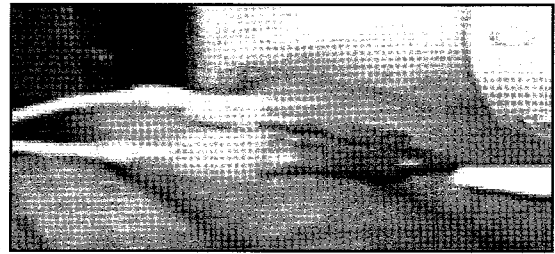

Figure 2

5. The wire leads to the igniter are connected to the wire harness with 1/4 inch male/female spade connectors. Disconnect the connectors and remove the igniter from the ash pan opening in the front of the appliance. **Figure 2.**

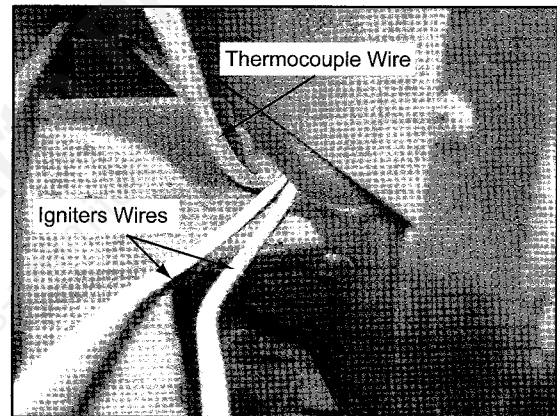

Figure 3

6. The female spade connectors attached to the igniter will slide through the opening in the cast firebox in the back of the appliance. **Figure 3.**

GENERAL INSTRUCTIONS

1. Follow proper shutdown procedures above.
2. To access the igniter you will first need to remove the ash pan.

NOTE: On the Mt. Vernon AE Stove the ash pan is visible from the front of the stove. On the Mt. Vernon AE Insert and EDGE 60 Fireplace you will need to open the cast face/decorative front and remove the ash pan.
3. The igniter is fastened to the igniter chamber with a wing nut. Loosen the wing nut until the igniter slides free from the igniter chamber. **Figure 4.**
4. On the Mt. Vernon AE Stove, remove the right side panel to be able to access the wires. On the Mt. Vernon AE Insert remove the right cast side to access the wires.

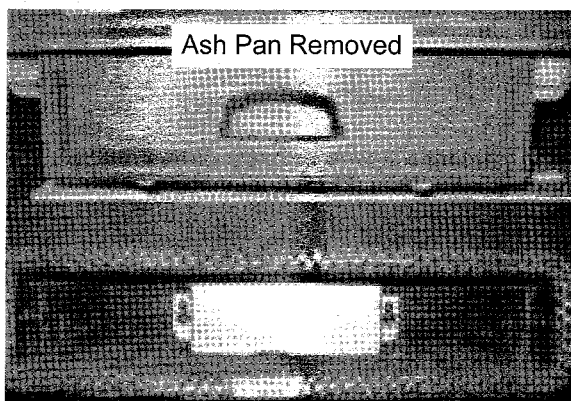

Figure 1

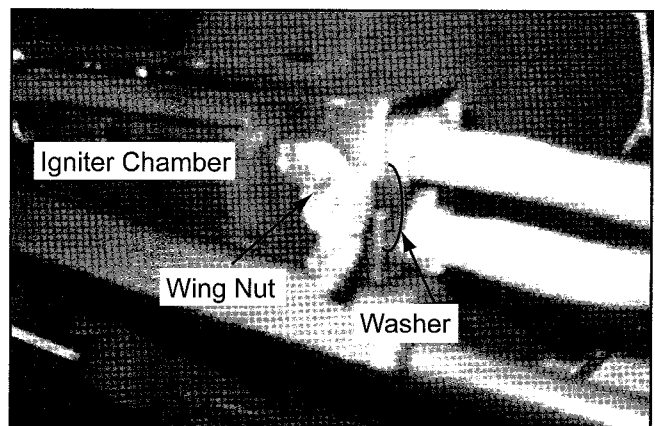

Figure 4

7. Install the new igniter into the chamber and place the washer between the igniter base and the inside of the igniter chamber. **Figure 4.**

AE TECHNOLOGY MODELS (Cont'd)

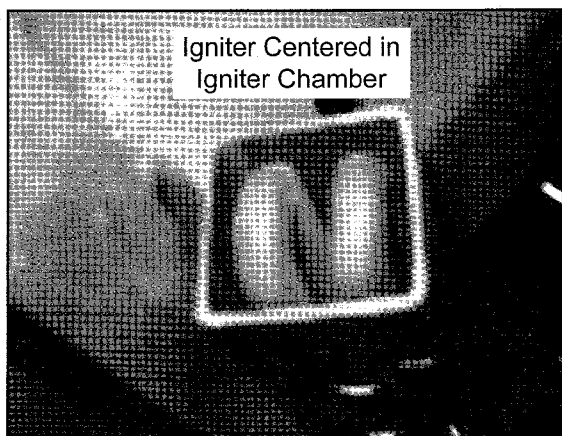

Figure 5

NOTE: Make sure the igniter is centered in the igniter chamber.

NOTICE

The thermocouple and igniter wires must be routed correctly to avoid:

- Damage to the wires by the firepot floor or auto-clean rails
- Igniter could short out

DO NOT route any wires around the auto-clean system.

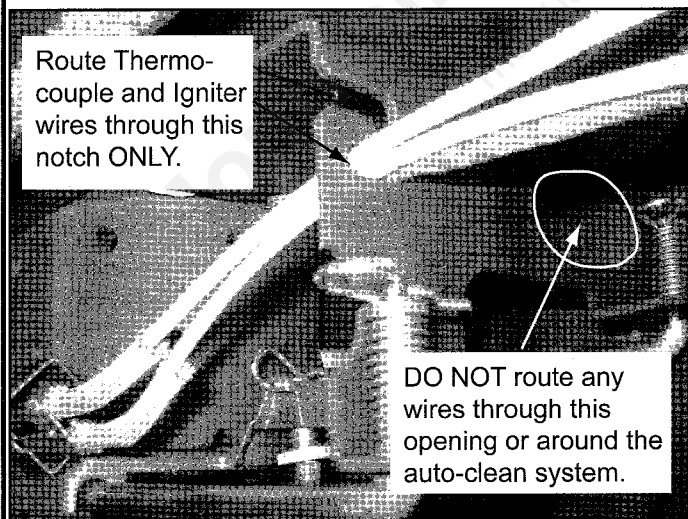

Figure 6

8. The igniter wires need to be routed through a notch in the firepot riser assembly. **Figure 6.**

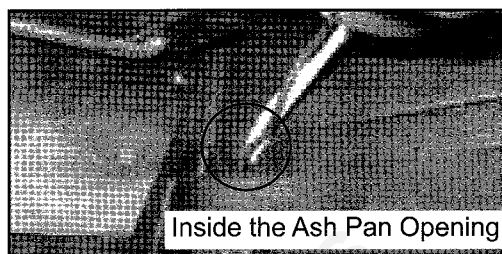

Figure 7

9. Feed the wires through the right corner opening in the cast. **Figure 7.**
10. Re-connect the wires to the 2 leads with the spade connectors. Refer to **Figure 2** on page 3.
11. Re-install the right side panel or right cast side depending on the model.