

INSTALLATION & OPERATION MANUAL

MODEL NUMBERS: 12-FPP 50-SFP12P 50-TFP12P
 12-FPL 50-SFP12L 50-TFP12L
 12-FPG 50-SFP12G 50-TFP12G

*Thank you for purchasing this product from a fine line of heating equipment.
We wish you many years of safe heating pleasure with your new heating appliance.
Save These Instructions.*

IMPORTANT: IF YOU HAVE A PROBLEM WITH THIS UNIT DO NOT RETURN IT TO THE DEALER. CONTACT TECHNICAL SUPPORT @ 1-800-245-6489.

Questions? Need Parts or Options? www.englishstoves.com

Please Note the Following Precautionary Statements:

England's Stove Works highly recommends the use of smoke detectors and Carbon Monoxide detectors with any hearth product, including this unit. Follow all manufacturer's instructions when using smoke or Carbon Monoxide detectors.

CAUTION: This unit must be installed in accordance with these instructions and must comply with local building and fire codes. Failure to do so could result in a chimney or house fire.



Keep children, furniture, fixtures, and all combustible materials away from any heating appliance. Refer to this owner's manual for all clearances to combustible materials.

DO NOT INSTALL THIS UNIT IN A MOBILE HOME!!!

DO NOT MODIFY THIS UNIT IN ANY WAY!!!

SAVE THIS MANUAL FOR FUTURE REFERENCE.

Non-Effectuated Facility 35 to 1 Air to Fuel Ratio

Read this entire manual before you install and use your new room heater. If this room heater is not properly installed, a house fire may result. To reduce the risk of fire, follow the installation instructions. Failure to follow instructions may result in property damage, bodily injury, or even death.

IMPORTANT NOTICE: This unit must be properly installed to prevent the possibility of a house fire or "smoke-back." The instructions must be strictly adhered to.

Do not use makeshift methods or material which may compromise the installation.

Your unit requires periodic maintenance and cleaning (refer to manual). Failure to maintain your unit may lead to a variety of problems, including but not limited to smoke spillage into the home. England's will not be liable for consequential or indirect damages to property or persons resulting from the use of this product.

Rev. 1/10



A letter from our Technical Support department:

Thank you for purchasing this fine product from England's Stove Works!

England's Stove Works was started, and is still owned by, a family that believes strongly in a "Do It Yourself" spirit – that's one reason you found this product at your favorite "Do It Yourself" store.

We intentionally design and build our stoves so that any homeowner can maintain his or her unit with basic tools, and we're always more than happy to show you how to do the job as easily and as inexpensively as possible.

From our free, downloadable service sheets, to our new "wizard-style," click-through Troubleshooting guide on our web site, we have always tried to help our customers stay "heat-ready," especially when oil and electricity prices continue to skyrocket.

Please look at our vast Help section on our web site and call our Technical Support department at (800) 245-6489 if you need any help with your unit. We are nearly always able to help "walk you through" any repairs, problems or questions you may have.

PLEASE NOTE: While information obtained on our web site and through our 800 number is always free of charge, there will be a service charge incurred with any "on-site" repairs or maintenance that we may arrange.

Wishing you years of efficient, quality and "comfy" heating,
England's Stove Works
Technical Support Department

www.englanderstoves.com

(800) 245-6489

IF YOU HAVE A PROBLEM WITH THIS UNIT DO NOT RETURN IT TO THE DEALER.
CONTACT TECHNICAL SUPPORT at 1 (800) 245-6489.

CAUTION

If you have any doubt concerning your ability to complete your installation in a professional-like manner after reading these instructions, you should obtain the services of an installer who is versed in all aspects as to the correct and safe installation. **Do not** use temporary, makeshift compromises during installation.

BEFORE INSTALLATION OF YOUR APPLIANCE

- 1. HOT WHILE IN OPERATION. KEEP CHILDREN, CLOTHING AND FURNITURE AWAY. CONTACT MAY CAUSE SKIN BURNS.**
- 2. DO NOT BURN GARBAGE OR FLAMMABLE FLUIDS.**
3. Check with the building inspector's office for compliance with local codes; a permit may be required.
4. This room heater must be connected to (1) a listed Type HT (2100°F) chimney per UL 103 or ULC S629, or (2) a code-approved masonry chimney with a flue liner. The chimney size should not be less than the area of the flue collar, or more than three times greater than the cross-sectional area of the flue collar.
5. A 6" diameter flue is required for proper performance.
6. Always connect this unit to a chimney and **NEVER** vent to another room or inside a building.
7. **DO NOT** connect to any duct work to which another appliance is connected, such as a furnace.
8. **DO NOT** connect this unit to a chimney flue serving another appliance.
9. **DO NOT USE CHEMICALS OR FLUIDS TO START THE FIRE.**
10. The connector pipe and chimney should be inspected periodically and cleaned if necessary.
11. Remember the clearance distances when you place furniture or other objects within the area. **DO NOT** store wood, flammable liquids or other combustible materials too close to the unit.
12. Contact your local fire authority for information on how to handle a chimney fire. Have a clearly understood plan to handle a chimney fire. In the event of a chimney fire, turn air control to a closed position and **CALL THE FIRE DEPARTMENT.**
13. **DO NOT** tamper with the combustion air control beyond normal adjustment.
14. Once the required draw is obtained, operate only with doors closed; open doors slowly when re-fueling (this will reduce or eliminate smoke from entering the room).
15. **DO NOT** install these units in a mobile home or trailer. These units are **NOT** mobile home approved.
16. Visit our web site at www.englanderstoves.com for helpful information, frequently asked questions, parts/accessory orders and more. **Technical Support: (800) 245-6489.**

OPERATION

WHY THE CORRECT FLUE SIZE IS IMPORTANT: 6”

“Draft” is the force that moves air from the appliance up through the chimney. The amount of draft in your chimney depends on the length of the chimney, local geography, nearby obstructions, and other factors. Too much draft may cause excessive temperatures in the appliance. An uncontrolled burn or a glowing red part or chimney connector can indicate excessive draft. Inadequate draft may cause back puffing into the room and “plugging” of the chimney and/or cause the appliance to leak smoke into the room through appliance and chimney connector joints.

Today’s solid fuel appliances are much more efficient than in the past. The units are designed to give you controlled combustion, as well as maximum heat transfer, using less fuel to do so.

The design of your new appliance is such that the exhaust “smoke” is now at lower temperatures than in the past, therefore requiring proper chimney size to give adequate draft. If your chimney is too large, the heating appliance will have a difficult time to raise the “chimney flue” temperature to give adequate draft, therefore causing a smoke back up, poor burn, or both.

Should you experience such problems, call in a local chimney expert.

With the door closed, the rate of burning is regulated by the amount of air allowed to enter the unit through the air control. With experience, you will be able to set the control for heat and burning time desired.

Attempts to achieve higher output rates that exceed heater design specifications can result in permanent damage to the heater. The recommended wood load is level with the top of the firebricks. Overloading may prevent sufficient air entering the heater to properly fuel the fire.

Do not tamper with the combustion air control beyond the normal adjustment capacity.

Operate this heater only with the door closed, and installed damper in the fully open position.

ALWAYS PROVIDE A SOURCE OF FRESH AIR INTO THE ROOM WHERE THE UNIT IS INSTALLED. FAILURE TO DO SO MAY RESULT IN AIR STARVATION OF OTHER FUEL BURNING APPLIANCES AND THE POSSIBLE DEVELOPMENT OF HAZARDOUS CONDITIONS.

THIS HEATER IS EXTREMELY HOT WHILE IN OPERATION. SERIOUS BURNS CAN RESULT FROM CONTACT. CAUTION SHOULD BE OBSERVED, ESPECIALLY WHEN CHILDREN ARE PRESENT.

**OPTIONAL BLOWER: MODEL AC-16
120 VOLTS, 60Hz, 0.75 AMPS, 2900 RPM
DANGER: RISK OF ELECTRIC SHOCK. DISCONNECT POWER BEFORE SERVICING UNIT.**

OPTIONAL BLOWER MOTOR OPERATING INSTRUCTIONS:

This unit is set up for installation of an optional 2-speed blower motor. The fan speed should be run on “Low” when the unit is operating at lower burn settings, and set to “High” for high burns.

See Illustration 3 (later in this manual) for installation location of your optional blower. Fasten blower motor to rear heat shield with the four screws that are already provided on your stove. When routing the power cord, be sure that the cord does not come into contact with any hot surface.

The optional heat circulation blower on this stove requires periodic lubrication; this lubrication should be performed no less than every three months of normal operation. To properly lubricate the blower, use an eye dropper or similar dispensing device to drip 5-7 droplets of SAE 20 oil into the oil port on the side of the blower motor.

FLUE SYSTEM

1. Existing Flue System

If you have chosen a freestanding unit, this stove is designed to connect to an existing flue system, such as masonry or a pre-manufactured Class A flue system. If you have a masonry flue system, the inner liner should be inspected carefully for cracks; if there is no liner in your chimney, we recommend you install a steel liner or have one installed. If you have an existing pre-manufactured system the inner liner should be inspected for warping or buckling. Either type chimney system should be thoroughly cleaned before installing your new stove. We strongly recommend you have a qualified chimney sweep clean and inspect your entire system, as the sweep can spot problems you might overlook. The sweep in most cases can make any necessary repairs or recommend a qualified person to do so. **It is not permissible to connect this unit to a chimney that is servicing another unit.**

2. Flue Size

The proper flue size is determined by measuring the inside diameter of the flue collar on the unit. This stove is equipped with a six inch (6") TOP EXHAUST FLUE COLLAR. Therefore, the connector pipe should be six inches (6") and never less in diameter than the collar on the stove. The area of the chimney liner must also be equal to or greater than the area of the flue collar on the stove. If the area of the flue is greater than the collar, it should never be more than three (3) times greater.

The black connector pipe should be 24 gauge steel and 10.5" from a combustible wall or ceiling. This clearance can be reduced to 10.0" if you are using a double wall or shielded pipe. (See "C" in the clearances diagrams on the following page)

3. Installation of a New Flue System

Note: Flue systems and flue pipe are not furnished with the unit.

Masonry Flue: In the event that you plan to install or have a system installed, there are several approaches that you can take. In the middle and late seventies masonry flue systems became very popular, and today this type system is satisfactory. If you are considering a masonry system, you should consult with your local building officials for the proper procedures on this type chimney. We recommend you consult with and have your flue built by a licensed, bonded contractor. Most masonry chimney systems are placed against an outside wall and extend upward beside the house. The flue thimble is then inserted through the wall, making the connection with the stovepipe and the vertical flue. Exercise extreme caution when drilling through the wall -- you must maintain proper clearance between the connecting liner and any combustible material in the wall.

We also recommend you have a flue clean-out door located at least two feet (2') below your thimble for easy cleaning of the system. This door should be made as airtight as possible. It is the consumer's responsibility to ensure the chimney system is safe and in good operating condition. **The manufacturer will not be held responsible for an accident attributed to a unit connected to a faulty chimney system.**

CLEARANCE TO COMBUSTIBLES (See Illustration 1)					
Appliance Clearances	Unprotected Surfaces				
	Side (A)	Rear (B)	Corner (D)	Flue to backwall (C)	Flue to wall (corner) (E)
Single wall connector, with and without side heat shields	6 in	6 ½ in	5 in	10 ½ in	14 in
Double wall connector, with side heat shields	6 in	6 ½ in	5 in	10 in	13 ½ in
NOTE: Minimum alcove or ceiling height = 77 in					

INSTALLATION APPLICATIONS
Illustration 1

NOTE:

1. Horizontal run not to exceed 6'.
2. Total flue length should not exceed 25'.
3. Floor protection required:
Min. size 48" x 48".
4. Always check local codes for clearances, installation, etc.

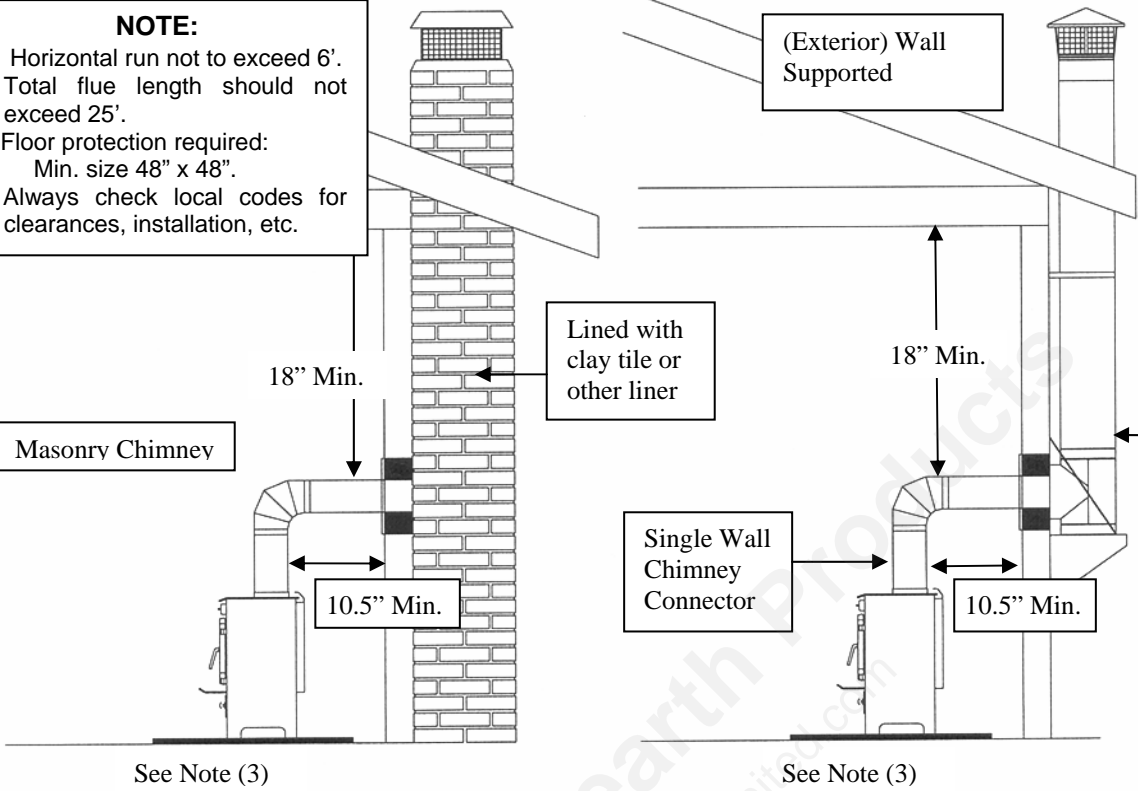

Masonry Chimney

(Exterior) Wall Supported

Lined with clay tile or other liner

Single Wall Chimney Connector

See Note (3)

See Note (3)

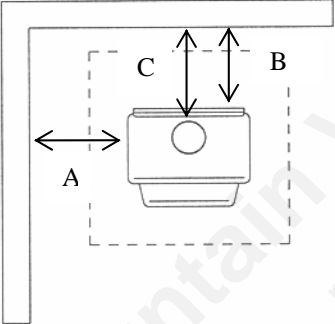

See Note (3)
And Floor Protection section

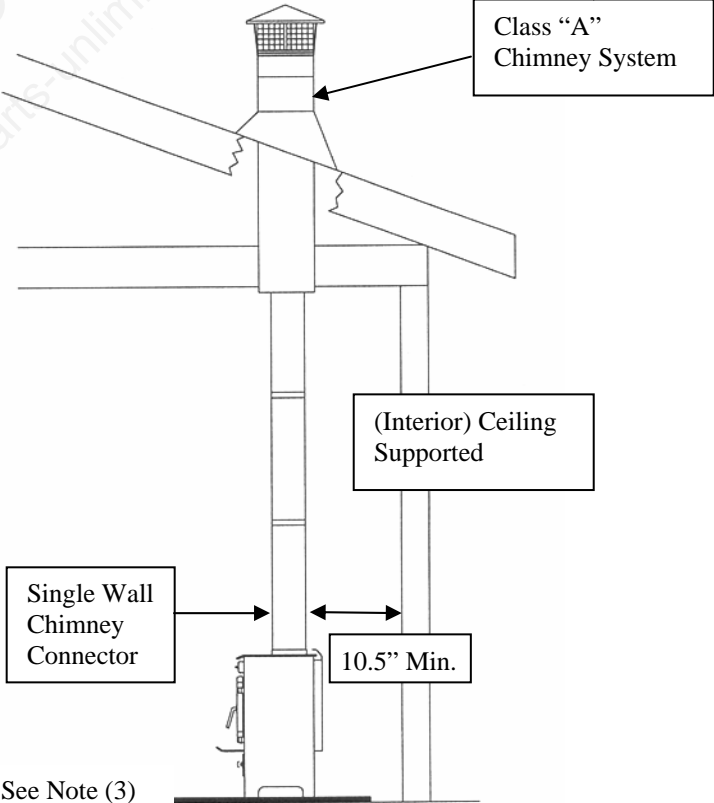
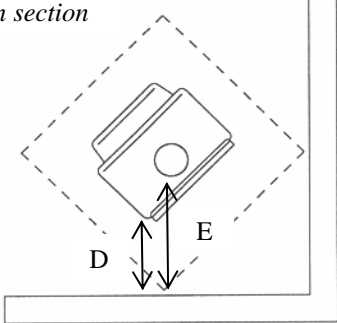

Class "A" Chimney System

(Interior) Ceiling Supported

Single Wall Chimney Connector

See Note (3)

***IMPROPER INSTALLATION:** The manufacturer will not be held responsible for damage caused by the malfunction of a stove due to improper installation. Do not use makeshift methods or material which may compromise the installation. The manufacturer will not be responsible for an accident caused by a unit connected to a faulty flue system. England's will not be liable for consequential or indirect damages to property or persons resulting from the use of this product. Call (800-245-6489) and/or consult a professional installer if you have any questions.

Chimney Connector Systems and Clearances from Combustible Walls for Residential Heating Appliances

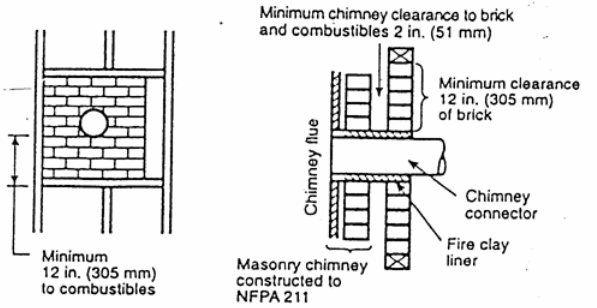

- A Minimum 3.5-in thick brick masonry all framed into combustible wall with a minimum of 12-in brick separation from clay liner to combustibles. The fireclay liner shall run from outer surface of brick wall to, but not beyond, the inner surface of chimney flue liner and shall be firmly cemented in place.

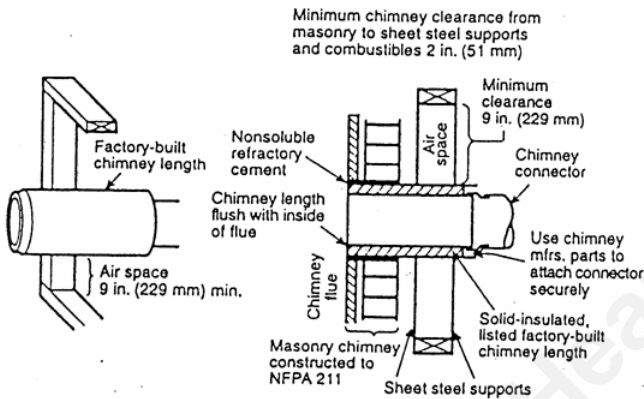

- B Solid-insulated, listed factory-built chimney length of the same inside diameter as the chimney connector and having 1-in. or more of insulation with a minimum 9-in. air space between the outer wall of the chimney length and combustibles.

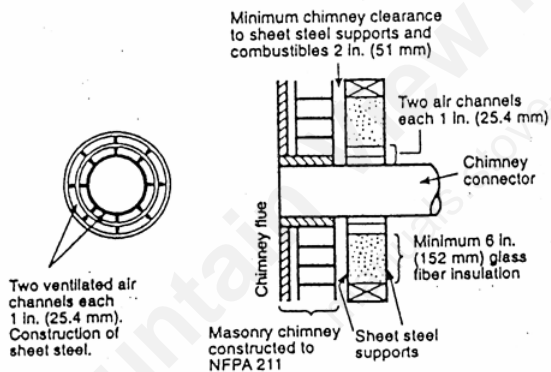

- C Sheet steel chimney connector, minimum 24 gauge in thickness, with a ventilated thimble, minimum 24 gauge in thickness, having two 1-in. air channels, separated from combustibles by a minimum of 6-in. of glass fiber insulation. Opening shall be covered, and thimble supported with a sheet steel support, minimum 24 gauge in thickness.

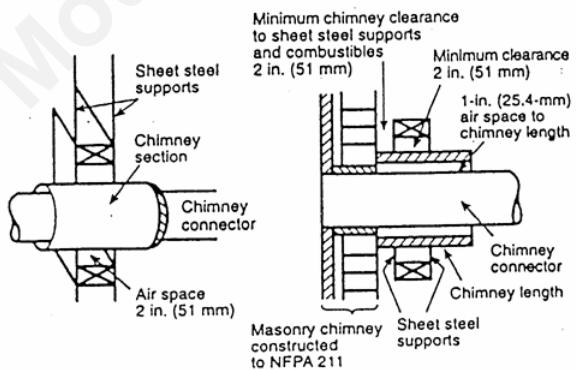

- D Solid insulated, listed factory-built chimney length with an inside diameter 2-in. larger than the chimney connector and having 1-in. or more of insulation, serving as a pass-through for a single wall sheet steel chimney connector of minimum 24 gauge thickness, with a minimum 2-in. air space between the outer wall of chimney section and combustibles. Minimum length of chimney section shall be 12-in. chimney section spaced 1-in. away from connector using sheet steel support plates on both ends of chimney section. Opening shall be covered, and chimney section supported on both sides with sheet steel supports securely fastened to wall surfaces of minimum 24 gauge thickness. Fasteners used to secure chimney section shall not penetrate chimney flue liner.

INSTALLATION APPLICATIONS, Cont'd.
Illustration 1b

Pre-Manufactured Flue System: In the past few years pre-manufactured flue systems have become very popular, because this type system is easily installed and, when done correctly, is very safe. There are many pre-manufactured flue systems on the market, and when making your choice it should be U.L., B.O.C.A. or I.C.B.O. approved. Any of these systems are constructed of the proper materials and meet the proper safety standards. Your local dealer normally handles an approved brand of flue pipe. There are two very popular methods for installation of this type system.

The *first*, most popular and least expensive is through the ceiling and out the roof. This is the most direct route and creates a good draw because it requires less pipe. It is less expensive because insulated pipe is needed only from the ceiling to the roof and above -- single wall chimney connect, 24 gauge or thicker is used from the unit to the ceiling; maintain 10.5" clearance between single wall chimney connector and any combustibles.

The *second* method for installing a pre-manufactured system is to exit through the wall and run the system vertically up the outside of the structure. This method is more expensive because more insulated pipe is required -- you must use insulated pipe through the wall and up the outside of the structure. In either installation, proper clearances to combustibles should be maintained. Your flue pipe manufacturer furnishes a wall thimble or ceiling support box and, when installed properly, the correct clearances are achieved. If you are unable to install this type system your local dealer may be able to recommend a qualified contractor for this installation. It is the customer's responsibility to ensure that his system is installed properly and is in good operating condition.

FLOOR AND WALL PROTECTION

1. Floor Protection

You will not need any floor protection if your floor is constructed of a non-combustible material such as brick or concrete. If your floor is constructed with a combustible material such as hardwood, carpet or linoleum, you must place protection between the stove and the combustible material.

There are many floor and wall board manufacturers, and you should be very cautious in choosing the proper protection. The type board you choose should be U.L. rated and listed. After examining the area you plan to place your stove and determining it requires a board, the next step is to select the proper size. The stove you choose will determine the size board that is required. The approved protector board should be large enough to provide a minimum of eight inches (8") behind the unit, eight inches (8") on either side and sixteen inches (16") in the front where the door is located. Floor protection should also exist under the chimney connector, and should extend two inches (50 mm) beyond each side of the chimney connector. This stove requires a minimum standard floor protector size of 48" x 48".

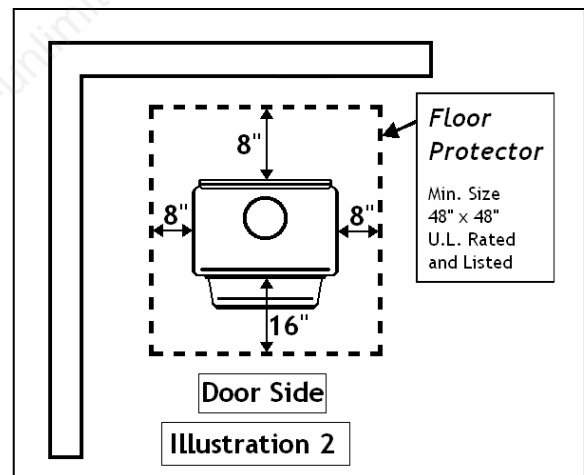

Installation on a Concrete Floor

An appliance mounted on a concrete floor does not require floor protection.

Carpeting and any other combustible material must not cover the Floor Protector.

If a combustible surface is applied to the concrete floor, a clearance must be maintained equivalent to the area reserved for the floor protector.

Installation on a Combustible Floor

If the appliance is to be installed on a combustible floor or a combustible floor covering, it must be installed on a 1" thick non-combustible millboard floor protector or a durable equivalent, with a "R" factor of no less than "2." The pad must be installed beneath the unit, extending 16" (U.S.) on the side equipped with a door, and 8" on all other sides. The pad must cover any horizontal chimney connector runs and extend 2" beyond each side.

Alternate Floor Protection:

An easy means of determining if a proposed alternate floor protector meets requirements is to follow this procedure:

- 1) Convert specification to R-value:
 - i R-value is given – no conversion is needed
 - ii k-factor is given with a required thickness (T) in inches: $R = 1/k \times T$
 - iii C-factor is given: $R = 1/C$
- 2) Determine the R-value of the proposed alternate floor protector:
 - i Use the correct formula given in step 1 (above) to convert values not expressed as "R."
 - ii For multiple layers, add R-values of each layer to determine overall R-value.
- 3) If the overall R-value of the system is greater than the R-value of the specified floor protector, the alternate is acceptable.

EXAMPLE:

The specified floor protector should be ¾" thick material with a k-factor of 0.84. The proposed alternate is 4" brick with a C-factor of 1.25 over 1/8" mineral board with a k-factor of 0.29.

Step (a): Use formula above to convert specification to R-value. $R = 1/k \times T = 1/0.84 \times .75 = 0.893$

Step (b): Calculate R of proposed system.

4" brick of $C = 1.25$, therefore $R_{\text{brick}} = 1/C = 1/1.25 = 0.80$

1/8" mineral board of $k = 0.29$, therefore $R_{\text{min.bd.}} = 1/0.29 \times 0.125 = 0.431$

Total $R = R_{\text{brick}} + R_{\text{mineral board}} = 0.8 + 0.431 = 1.231$

Step (c): Compare proposed system of R of 1.231 to specified R of 0.893. Since proposed system R is greater than required, the system is acceptable.

Definitions:

$$\text{Thermal conductance} = C = \frac{\text{Btu}}{(\text{hr})(\text{ft}^2)(\text{deg F})} = \frac{W}{(\text{m}^2)(\text{deg K})}$$

$$\text{Thermal conductivity} = k = \frac{(\text{Btu})(\text{inch})}{(\text{hr})(\text{ft}^2)(\text{deg F})} = \frac{W}{(\text{m})(\text{deg K})} = \frac{\text{Btu}}{(\text{hr})(\text{ft})(\text{deg F})}$$

$$\text{Thermal resistance} = R = \frac{(\text{ft}^2)(\text{hr})(\text{deg F})}{\text{Btu}} = \frac{(\text{m}^2)(\text{deg K})}{W}$$

2. Wall Protection

Please see **Illustration 1** for clearances to walls. In some areas local codes may require thirty-six inches (36") from a combustible, therefore it is very important that you check with local officials. If you need to place your unit closer to a combustible wall, some protection will be necessary. If an approved wall board is used this will reduce your clearance by two thirds (2/3); however, a one inch (1") air space has to be between the board and the wall. If you have a ceiling flue hook-up, you will need protection from the floor to the ceiling if you do not meet the normal clearances. If you have a wall flue hook up, you will need wall protection at least twelve inches (12") above the wall thimble.

3. Side Heat Shields

This accessory item comes with the hardware (six (6) mounting screws) necessary to install it on the rear of the stove. This is a two-piece heat shield, but is installed one piece at a time. There are pre-punched holes on each side of the Rear Heat Shield; while holding each piece of the Side Heat Shield in place, align the pre-punched holes in the Side Heat Shield with the existing holes in the Rear Heat Shield, and fasten with the screws provided.

See **Illustration 1** for clearances with and without side heat shields.

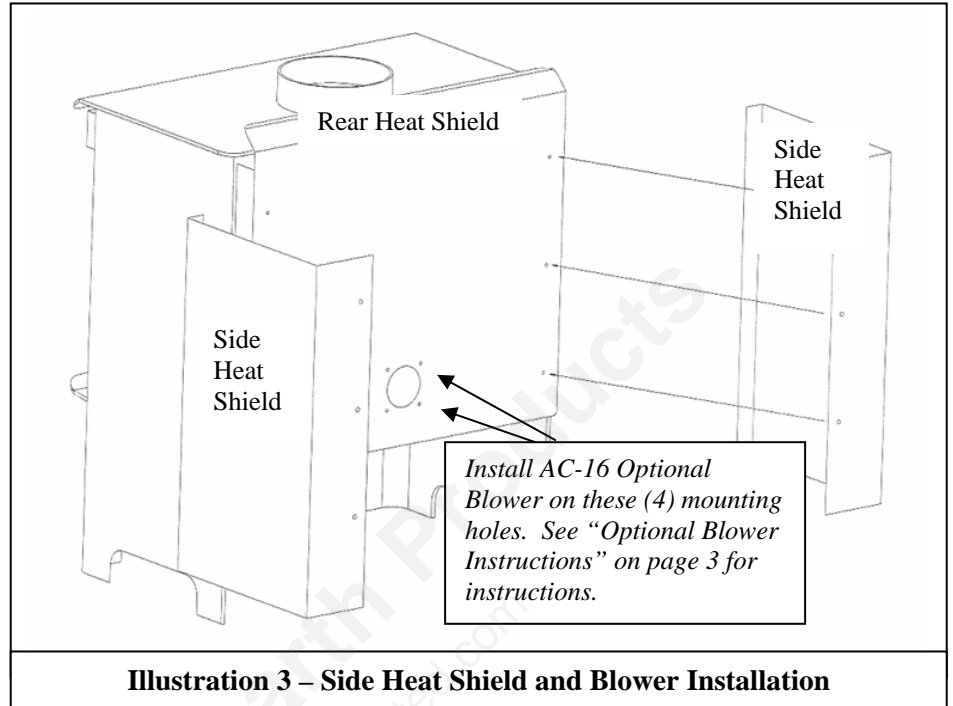

- BRICK LAYOUT**
- 1 – 9" x 4" x 1.25" brick (Qty. 14)
 - 2 – 4" x 4.5" x 1.25" brick (Qty. 2)
 - 3 – 4.5" x 4" metal plate (Ash Drawer Plate, Qty. 1)

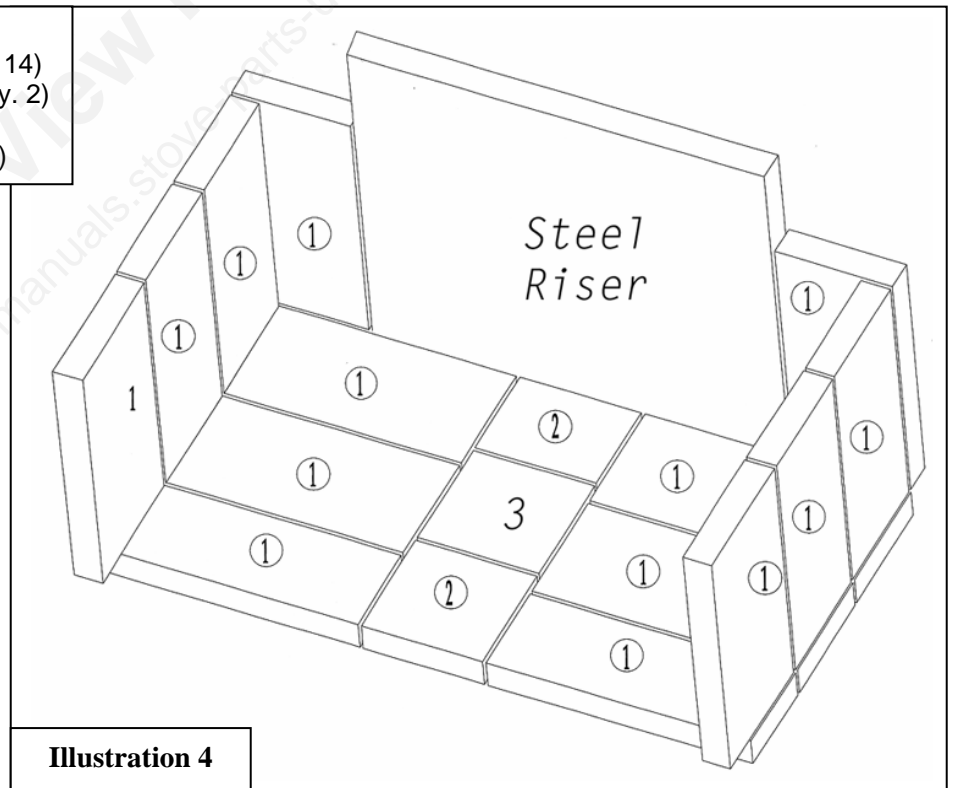

FREESTANDING PLACEMENT AND INSTALLATION

The first problem you may encounter is getting your stove into your home -- all of our stove products are well constructed, which makes them rather heavy. Three to four adults can normally handle a unit, but we still recommend using a handcart. Never attempt to handle a heating product alone!!! The door and brick can be temporarily removed to lighten the unit (refer to Brick Layout). After the unit is placed into position, install the spring handles and attach any optional equipment.

Chimney Connector Pipe

The black pipe must be six inches (6") in diameter and at least 24 gauge steel pipe. Do not use aluminum or galvanized steel pipe, as it will not withstand the extreme temperatures generated by the stove. Also, do not use single wall connector pipe as a chimney -- you must connect your stove to a chimney comparable to those listed earlier in this manual. The crimped end of your pipe should be inserted into the flue collar and, by doing this, all the pipe will be reversed. If you use this method the creosote will run back down the inside of your pipe and not out of the joints onto your stove. As a safety precaution, all joints should be sealed with high temperature silicone (**AC-RTV3**) and secured with sheet metal screws.

For proper operation the chimney connector should be as short as possible and never exceed a six foot (6') horizontal run. Horizontal runs of chimney connector pipe should have an upward slope of one quarter of an inch (1/4") per foot. You will need to maintain 10.5" of clearance from the wall and 18.0" from the ceiling unless you are using double wall or shielded pipe.

Attach and secure the chimney connector to the stove with a minimum of three (3) sheet metal screws, and also use a minimum of three (3) sheet metal screws to secure each adjoining section of pipe.

INSTALLATION

1. Remove all parts from inside the stove body. (If you purchased a leg unit, and it has the factory packaging, remove the body of the stove from the shroud that it is attached to, referring to **Illustration 7** later in this manual. Those instructions detail how to exchange legs and pedestal, but removal of the shroud is accomplished in the same manner).
2. Select the proper location for the stove. These appliances must not be installed any closer than the minimum clearance to combustible materials shown in **Illustration 1**. The stove must be installed on a non-combustible surface as shown in **Illustration 1** and **Illustration 2**.

FAILURE TO FOLLOW THE MINIMUM CLEARANCE REQUIREMENTS MAY RESULT IN AN UNSAFE INSTALLATION.

3. If non-combustible materials have been installed on the walls, obtain the minimum clearances from either the manufacturer of these materials or the local building inspector's office.
4. Install the stovepipe **INSIDE** the flue collar on the top of the stove, between the stove and the chimney.
5. **DO NOT** use a grate to elevate the fire.
6. A clearance of 10.5" between single wall chimney connector and combustible materials is required. Check with authorities having jurisdiction in your area with any questions.
7. All pipe sections must be connected with the male (crimped) end toward the stove.
8. Fasten the stove pipe to the flue collar by the use of three sheet metal screws. Do the same at each additional joint to make the entire installation rigid.
9. Maintain the required diameter flue for the entire installation.
10. If you are connecting the stove to an old masonry flue, be sure to have it inspected for cracks and general condition. Relining with a stainless steel liner may be required.
11. It is recommended that no more than two 90-degree bends be used in the stovepipe installation. More than two 90-degree bends may decrease the amount of draw, and possibly cause smoke spillage.
12. This unit has a factory-installed damper. Do not install or use additional dampers with this unit.
13. Single wall flue pipe assemblies must not exceed 10 feet in overall length.

CHIMNEY

REFER TO CHIMNEY AND CHIMNEY CONNECTOR MANUFACTURER'S INSTRUCTIONS

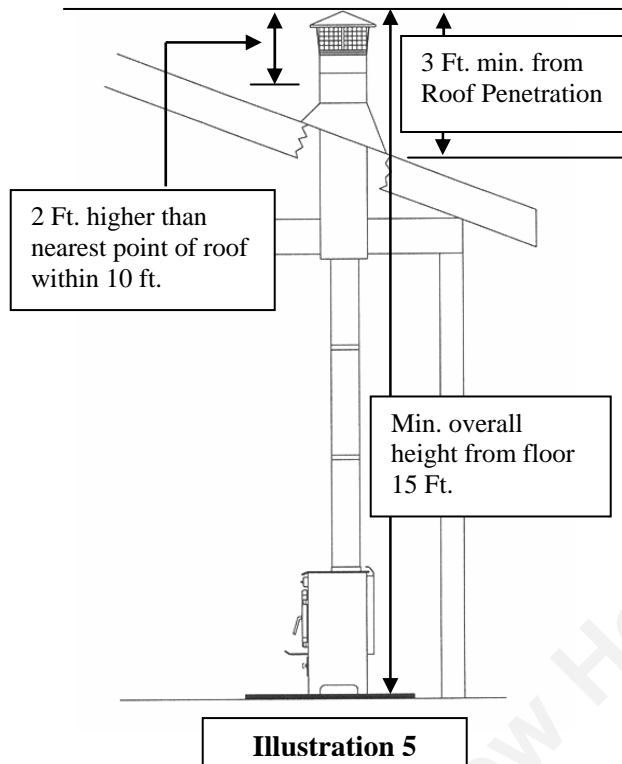

CONTACT YOUR LOCAL BUILDING AUTHORITY FOR APPROVED METHODS OF INSTALLATION

1. This appliance requires a masonry or pre-manufactured chimney listed to UL103HT sized correctly.
2. If a masonry chimney is used, it is advisable to have your chimney inspected for cracks, and check the general condition before installing your unit. **Relining may be required to reduce the flue diameter to the appropriate functional size.**
3. To help ensure a good draft, the top of the chimney should be at least 3 feet above the point of penetration through the roof, and be at least 2 feet higher than any point of the roof within 10 feet.
4. The chimney connector shall not pass through an attic, roof space, closet, concealed space, floor, ceiling, wall, or any partition of combustible construction.
5. The minimum overall height of your chimney should be 15 feet from the floor.
6. Do not use makeshift compromises during installation.

OPERATION

Do not use a grate or elevate the fire. Build the wood fire directly on the bricks. When the stove is used for the first time, solvents in the paint will smoke off as the stove “cures.”

WOOD –

This heater is designed to burn natural wood only. Higher efficiency and lower emissions generally result when burning air-dried seasoned hardwood, as compared to softwood or to green or freshly-cut hardwood.

Use only dry, seasoned wood. Green wood, besides burning at only 60 percent of the fuel value of dry wood, deposits creosote on the inside of the stove and along the chimney. This can cause extreme danger of chimney fire. **To be called “seasoned,” wood must be dried for a year.** Regardless of whether the wood is green or seasoned, it should be stored in a ventilated, sheltered area to allow proper drying during the year. Wood should be stored beyond recommended clearances from combustibles.

DO NOT BURN:

Treated Wood, Garbage, Solvents, Trash, Cardboard, Colored Paper or Coal.

FIRST FIRE –

- Remember to ventilate well.
- Allow the stove to cure before burning for long periods of time at high temperatures.
- Flat spots on the painted surface are normal.
- Shiny spots on the painted surface (before burning) are normal.
- Call Technical Support at (800) 245-6489 if you have any questions.

BUILDING A FIRE

1. Open the air inlet control and installed damper fully.
2. Place a small amount of crumpled paper in the stove.
3. Cover the paper with a generous amount of kindling in a “teepee” shape, and a few small pieces of wood.
4. Ignite this fuel and close the door most of the way (leave it open slightly).
5. Add larger pieces of wood as the fire progresses, being careful not to overload. **Do not fill the firebox beyond the firebrick area, as this may result in over-firing.** A coal bed of (ideally) 1” to 2” should be established to achieve optimum performance.
6. This unit is designed to function most effectively when air is allowed to circulate to all areas of the firebox. A good way of achieving this is to rake a small (1” to 2” wide) “trough” in the center of the coal bed, from front to back, prior to loading the fuel.
7. Once fuel has been loaded, close the door and fully open the air inlet control, until the fire is well established (approximately 20 minutes), being careful not to over-fire.
8. Readjust the air inlet control to the desired burn rate. If excessive smoke fills the firebox, open the air inlet control slightly, until flames resume and the wood is sufficiently ignited. Basically, Closed = “Low;” ½ Way Open = “Medium;” and Fully Open = “High.”
9. **When refueling, adjust the air control to the fully open position.** When the fire brightens, open the door **VERY** slowly and carefully. This will prevent gases from igniting and causing smoke and flame spillage.
10. At this point you may add fuel, being careful not to overload.
11. Only close the installed damper when the fire is completely out.

The use of flammable liquids, too much wood or burning trash in the stove may result in an “over-fired” unit. If the chimney connector pipe or stove turns red or white, the stove has been over-fired. In the event this happens, close the air control *immediately!* This condition can ignite creosote in the chimney and cause a house or chimney fire. This type fire can cause structural damage to the chimney system; do not use the stove again until the entire system has been checked thoroughly and any damaged parts repaired or replaced. A chimney sweep can normally perform this inspection.

NEVER USE GASOLINE, GASOLINE-TYPE LANTERN FUEL, KEROSENE, CHARCOAL LIGHTER FLUID, OR SIMILAR LIQUIDS TO START OR ‘FRESHEN UP’ A FIRE IN THIS HEATER. KEEP ALL SUCH LIQUIDS WELL AWAY FROM THE HEATER WHILE IT IS IN USE.

GLASS CARE

REPLACE GLASS ONLY WITH HIGH-TEMPERATURE ROBAX PYROCERAM OF THE PROPER SIZE AND THICKNESS.

The following use and safety tips should be observed:

1. Inspect the glass regularly for cracks or breaks. Surface scratches are acceptable and normal, but if you detect a crack or a break, extinguish the fire immediately, and contact your dealer or Technical Support at (800) 245-6489 for replacement (or log on to www.englishstoves.com).
2. Do not slam the door or otherwise impact the glass. When closing doors, make sure that logs or other objects do not protrude and impact the glass.
3. Do not clean the glass with materials which may scratch (or otherwise damage) the glass. Scratches on the glass can develop into cracks or breaks.
4. Never attempt to clean the glass while the unit is hot. If the deposit is not very heavy, normal glass cleaners are adequate with a plain, non-abrasive scouring pad. Heavier deposits may be removed with the use of an oven cleaner.
5. NEVER put substances that can ignite explosively inside the unit, since even small explosions in confined areas can blow out the glass.
6. This unit has an airwash system, designed to reduce deposits on the glass.

GASKET REPLACEMENT

After extensive use, the sealing material which provides glass and door seal may need to be replaced if it does not sustain its resilience. Inspect the glass and door seal periodically to ensure proper seal. If the gaskets become frayed or worn, replace immediately. Contact your dealer or Technical Support at (800) 245-6489 for approved replacement parts.

The following steps should be followed for replacement of the glass gasket:

1. Ensure that the appliance is not in operation, and is thoroughly cooled.
2. Remove the screws and glass clips.
3. Lift glass out from glass clips.
4. Remove the old gasket, and clean the glass.
5. Replace the new gasket, starting at the bottom of the glass and working along the edges. Be sure to center the gasket channel on the glass.
6. Trim the gasket to length and butt the ends together.
7. Replace the glass in the door, being sure not to over-tighten the screw and clip.

You may order parts and options on our web site: www.englishstoves.com, or by calling (800) 516-3636 (parts orders only, call 800-245-6489 for technical questions).

The following steps should be followed for replacement of the door gasket:

1. Ensure the appliance is not in operation and is thoroughly cooled.
2. Remove the old door gasket and clean the gasket channel.
3. Using an approved high-temperature gasket cement, apply a thin coat in the bottom of the channel.
4. Starting at the hinge side of the door, work into the channel around the door unit, trim to length and butt the ends together.
5. Close the door and allow three to four hours for the cement to set before restarting any fire.

CREOSOTE

When wood is burned slowly, it produces tar and other organic vapors. These combine with moisture to form creosote. Creosote vapors condense in the relatively cool chimney flue of a slow-burning fire – as a result, creosote residue accumulates on the lining of the flue. If ignited, this creosote makes an extremely hot fire. The chimney should be inspected on a regular basis during the heating season, to determine if a creosote build-up has accumulated. If it has, the creosote should be removed to reduce the risk of chimney fire.

WARNING: THINGS TO REMEMBER IN CASE OF A CHIMNEY FIRE:

- | | |
|-------------------------------|------------------------------------|
| 1. CLOSE DRAFT CONTROL | 2. CALL THE FIRE DEPARTMENT |
|-------------------------------|------------------------------------|

WAYS TO PREVENT AND KEEP UNIT FREE OF CREOSOTE

1. Burn with the air control fully open for several minutes at numerous intervals throughout each day during the heating season, being careful not to over-fire the unit. This should remove the slight film of creosote that accumulates during low burn periods.
2. Burn the stove with the draft control fully open for approximately 20-30 minutes every time you apply fresh wood. This allows wood to achieve the charcoal stage faster, and burns wood vapors which might otherwise be deposited within the system.
3. **BURN ONLY SEASONED WOOD.** Avoid burning wet or green wood. Seasoned wood is wood that has been dried for at least one year.
4. A small, hot fire is preferable to a large, smoldering one that can deposit creosote within the system.
5. Establish a routine for fuel, wood burner and firing technique. Check daily for creosote build-up until experience shows you how often you need to clean to be safe. Keep in mind that the hotter the fire, the less creosote is deposited, and weekly cleanings may be necessary in milder weather, although monthly cleanings may be enough in the coldest months. Contact your local authority for information on how to handle a chimney fire, and have a clearly-understood plan to handle a chimney fire.

ASH DISPOSAL

Regularly inspect the ash build-up in your unit and remove as necessary. Ashes can be removed from the unit by shoveling them off the firebrick. This unit has an ash drawer plate (see **Illustration 4**) that can be removed from the stove; once removed, the ashes can be raked through the opening and into the ash pan.

Caution: The ash drawer plate can be extremely hot!! Never remove red-hot ashes from the appliance; allow ashes to cool before dropping into the ash pan. Ashes should be placed in a metal container with an airtight lid. The ashes should be placed on a noncombustible surface and completely away from any combustible materials. The ashes should remain in the airtight container until they have completely cooled.

Illustration 6 – Air Inlet Control		
CONTROL SETTINGS		
<p><u>Burn Rate</u> Low Med. Low Med. High High</p>	<p><u>Inlet Air Setting</u> Fully Closed $\frac{1}{4}$ Open $\frac{3}{4}$ Open Fully Open</p>	

	<p style="text-align: center;">DIRECTIONS FOR INSTALLATION OF LEGS OR PEDESTAL:</p> <p>(Stove must be cooled and all ashes cleaned out)</p> <ul style="list-style-type: none"> * Remove bricks, disconnect flue, and turn stove on its back. * If you are replacing existing legs or pedestal, disconnect the existing legs or pedestal. <p><i>To install legs:</i></p> <ol style="list-style-type: none"> 1. Each leg will fit into a pre-made slot on each corner of the bottom of the unit. 2. A 3/8" x 1-1/2" Carriage Bolt and matching nut is supplied with each leg. Fit a leg into a slot, and match the hole on the leg with the hole in the slot. Attach the legs one at a time, using the supplied bolts and nuts. Tighten securely. <p><i>To install pedestal:</i></p> <ol style="list-style-type: none"> 1. Place spacers (provided) between the slots on the unit and the pedestal base (one spacer will fit on each side of the pedestal). Match the four holes in the pedestal (2 on each side) with the holes in the spacers and slots on the unit. 2. Use the four 3/8" x 1-1/2" Carriage Bolts and nuts (provided) to attach the pedestal to the base of the stove. Tighten securely. <ul style="list-style-type: none"> * After attaching the legs or pedestal, turn unit upright, reconnect flue and replace bricks according to manual.
Illustration 7	Base Options and Details

IMPORTANT: HELPFUL HINTS AND TIPS WORTH REVIEWING

1. What is the correct way to start a fire?

- You will need small pieces of dry wood (kindling) and paper. Use only newspaper or paper that has not been coated or that has had materials glued or applied to it. Never use coated or colored paper (such as advertising flyers).
- Open the door of the wood stove.
- Crumple several pieces of paper, and place them in the center of the firebox, directly on the firebricks of the stove. Never use a grate to elevate the fire.
- Place small pieces of dry wood (kindling) over the paper in the form of a “teepee.” This allows for good air circulation, which is important for good combustion.
- Light the crumpled paper in two or three different locations. NOTE: It is important to heat the air in the stovepipe for draft to begin.
- Fully open the air control of the wood stove, and close the door until it is just **slightly** open, allowing for air to be introduced into the firebox. Never leave the door fully open, as sparks from the kindling may occur, causing injury. As the fire begins to burn the kindling, some additional kindling may be needed to sustain the fire. **DO NOT** add more paper after the fire has started.
- Once the kindling has begun to burn, start adding some small pieces of seasoned, dry firewood. NOTE: Adding large pieces at the early stages will only serve to smother the fire. Continue adding small pieces of seasoned, dry firewood, keeping the door slightly open until each piece starts to ignite. Remember to always open the door slowly when placing wood into the fire.
- Once the wood has started to ignite and the smoke has reduced, close the stove door fully. (Reduction of smoke is a good indication that the draft in the chimney has begun, and good combustion is now possible.) Larger pieces of seasoned, dry firewood can now be added when there is sufficient space in the firebox. Adjust the air control setting to your desired setting.
- NOTE: The lower the air control setting, the longer the burn time of the firewood.

2. What type of wood is best to use as firewood?

- Dry, seasoned hardwood should be used. Avoid green, unseasoned wood. Green wood, besides burning at only 60% of the fuel value of dry seasoned wood, will deposit creosote on the inside of the stove and along to inside of the chimney.

3. What does dry, seasoned wood mean, and what is considered to be hardwood?

- Wood that has been dried for a period of one year in a well-ventilated and sheltered area is considered dry, seasoned wood. Hardwoods generally come from slow-growth trees, such as Oak or Fir. Softwoods generally come from fast-growth trees, such as Pine or Spruce.

4. Will following the steps listed above result in a perfect fire every time?

- A good answer would be “most of the time.” There are many variables that can affect your rate of success when starting a fire, and experience will teach you how to deal with the variables. This section of the manual will cover some of the variables that can affect a fire, and time and patience will contribute to your ability to start a good fire consistently.

5. Why can't I get the fire lit?

- Damp or wet wood and poor draft are the main reasons for poor results when starting a fire. Remember to always use dry, seasoned wood for your fire. Even wood that has been dried (seasoned) for a long period of time will be difficult to light if it has gotten wet.

6. Why is there always a large quantity of thick black smoke in the firebox?

- A large quantity of thick black smoke in the firebox is a possible indication that you have poor draft.

- 7. Is it normal for soot to cover the glass at the beginning of a fire?**
- This stove has been built with an air wash system that will help keep the glass clear when the firebox has reached a good operating temperature, and also has a good draft. Cold firebox temperature and poor draft cause soot to form on the glass. Once the firebox temperature and the draft increase, the soot should burn off.
- 8. What is “draft?”**
- Draft is the ability of the chimney to exhaust draw by-products produced during the normal process of combustion.
- 9. What can cause a poor draft?**
- There are several common factors that can contribute to poor draft:
- A. Atmospheric Pressure and Air Supply**
- Atmospheric pressure affecting the draft from a chimney can be outside the home, inside the home, or both. Outside the home, a high-pressure (clear and cool) day generally creates a better draft in the chimney than a low-pressure (overcast and damp) day. Inside the home, household appliances, such as forced-air furnaces or clothes dryers, compete for air, often resulting in inadequate amounts of air available to fuel a fire and creating a condition known as negative pressure. Extreme conditions of negative pressure can cause the combustion by-products to be drawn from the chimney and into the house. This condition is commonly known as “down drafting.”
- There are several factors that can affect the amount of air available in the home. Increased amounts of insulation, vinyl windows, extra caulking in various places and door seals can all keep heat in, but may also make a home too airtight. If you are in doubt as to whether or not there is sufficient air in your home for your stove, refrain from using those appliances known to consume air when possible, or open a door or a window to allow some air to enter the home.
- B. Environmental Conditions**
- High trees, a low-lying house location (such as in a valley), tall buildings or structures surrounding your house and even windy conditions can cause poor draft or down drafting.
- C. Cold Chimney Temperature**
- Avoid cold chimney temperatures by burning a hot fire for the first fifteen to forty minutes after building a fire, being careful not to over-fire. If any part of the chimney or parts of the stove start to glow, you are over-firing the stove. Where possible, install a temperature gauge on the chimney so temperature drops can be seen.
- D. Chimney Installation and Maintenance**
- Avoid using too many elbows or long horizontal runs. If in doubt, contact a chimney expert and/or chimney manufacturer for help. Clean your chimney, rain cap(s) and especially the spark arrester regularly, in order to prevent creosote build-up – which can significantly reduce chimney draw and possibly create a chimney fire.
- 10. Should I close or open the air control fully when shutting down the stove?**
- When shutting down the stove, fully open the air control. This will allow chimney temperatures to remain as high as possible for as long as possible. Remember, cold chimney temperatures create creosote.

NOTE: This section is intended as an aid and does not supersede any local, state or like requirements. Check with officials or authorities having jurisdiction in your area.

PARTS, ACCESSORIES AND OPTIONS LIST

(Options and trim (*i.e. brass and nickel*) interchange for variety. Gold door and legs may also be ordered to replace existing door and pedestal or regular cast legs.)

REPLACEMENT PARTS

AC-G17	DOOR GLASS KIT WITH GASKET (16 ½ " x 9 ¼ " x .197")
AC-GGK	DOOR GLASS GASKET KIT (gasket only, no glass)
AC-DGKNC	DOOR GASKET KIT (5/8" High-Density fiberglass rope gasket)
AC-SB	9" X 4" X 1 ¼" FIREBRICK (see Brick Layout diagram)
AC-SB4.5	4" X 4 ½" X 1 ¼" FIREBRICK (see Brick Layout diagram)
AC-SH	BRASS DOOR SPRING HANDLE
AC-SHN	NICKEL DOOR SPRING HANDLE
AC-SH4	BRASS AIR CONTROL SPRING HANDLE
AC-SH4N	NICKEL AIR CONTROL SPRING HANDLE
AC-03	BRASS ASH PAN KNOB
AC-03BN	NICKEL ASH PAN KNOB
AC-MBSP	HI-TEMPERATURE BLACK PAINT

OPTIONS

AC-16	ROOM AIR BLOWER
AC-NCSHSB	SIDE HEAT SHIELD SYSTEM (BLACK)
AC-108	BRASS ACCENT TRIM RING FOR DOOR ("C," "P" AND "L" MODELS ONLY)
AC-108BN	NICKEL ACCENT TRIM RING FOR DOOR ("C," "P" AND "L" MODELS ONLY)
AC-107	BRASS LIP TRIM
AC-107BN	NICKEL LIP TRIM
CA-12G	GOLD PLATED LEG
CA-13G	GOLD PLATED DOOR

All parts can be ordered from your local dealer or from the factory at 1-800-516-3636.

NOTE: Parts and accessories are also available on our web site: www.englanderstoves.com .

If you have any questions or problems contact the Technical Support Department.

TECHNICAL SUPPORT DEPARTMENT

P.O. BOX 206

MONROE, VA. 24574

Technical Questions/Technical Support: (800-245-6489) (Fax: 434-929-4810)

Parts orders only: (800-516-3636)

service@englanderstoves.com



**LISTED SOLID FUEL ROOM HEATER
TESTED TO UL 1482**

WHI - []

MODEL: 12-FPP, 12-FPL & 12-FPG

50-SFP12P, 50-SFP12L & 50-SFP12G

50-TFP12P, 50-TFP12L & 50-TFP12G

PREVENT HOUSE FIRES - INSTALL AND USE ONLY IN ACCORDANCE WITH THE OWNER'S MANUAL PROVIDED WITH THIS APPLIANCE. CONTACT LOCAL BUILDING OR FIRE OFFICIALS ABOUT RESTRICTIONS AND INSTALLATION INSPECTIONS IN YOUR AREA.

INSTALLATION REQUIREMENTS - DO NOT CONNECT THIS UNIT TO A CHIMNEY FLUE SERVING ANOTHER APPLIANCE. USE A RESIDENTIAL TYPE MASONRY OR LISTED TYPE HT FACTORY-BUILT CHIMNEY. USE 2" MSG BLACK CHIMNEY CONNECTOR OR LISTED DOUBLE WALL CHIMNEY CONNECTOR. REFER TO LOCAL CODES AND THE CHIMNEY MANUFACTURER'S INSTRUCTIONS FOR PRECAUTIONS REQUIRED FOR PASSING A CHIMNEY THROUGH A COMBUSTIBLE WALL OR CEILING. PLACE ON NON-COMBUSTIBLE FLOOR PROTECTION, WHICH EXTENDS 16 INCHES TO THE FRONT AND 8 INCHES TO EACH SIDE OF THE FUEL OPENING. DO NOT OBSTRUCT THE SPACE BENEATH THE HEATER. ADHERE TO THE FOLLOWING MINIMUM CLEARANCES TO COMBUSTIBLES WHEN USING A SINGLE WALL CHIMNEY CONNECTOR. SEE OWNER'S MANUAL FOR ADDITIONAL CLEARANCE INFORMATION.

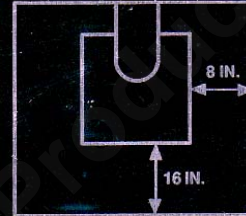
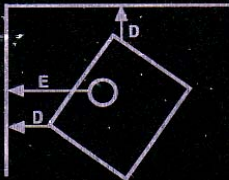

	SINGLE WALL CONNECTOR	DOUBLE WALL CONNECTOR
A	6-IN.	6-IN.
B	6.5-IN.	6.5-IN.
C	10.5-IN.	10-IN.
D	5-IN.	5-IN.
E	14-IN.	13.5-IN.

ALCOVE MINIMUM CEILING HEIGHT = 48-IN.

NON-EFFECTED FACILITY 35-TO 1 AIR TO FUEL RATIO

OPERATION REQUIREMENTS - FOR USE WITH SOLID WOOD FUEL ONLY. DO NOT OVERFIRE. IF HEATER OR CHIMNEY CONNECTOR GLOWS YOU ARE OVERFIRING. INSPECT AND CLEAN CHIMNEY FREQUENTLY. UNDER CERTAIN CONDITIONS OF USE CREOSOTE BUILDUP MAY OCCUR RAPIDLY. DO NOT USE GRATE OR ELEVATED FIRE. BURN WOOD FIRE DIRECTLY ON HEARTH. RISK OF SMOKE AND FLAME SPILLAGE, OPERATE ONLY WITH DOOR FULLY CLOSED.

ELECTRICAL RATING: 115V 60HZ .8 AMP



CAUTION:

HOT WHILE IN OPERATION. DO NOT TOUCH. KEEP CHILDREN, CLOTHING, AND FURNITURE AWAY. CONTACT MAY CAUSE SKIN BURNS.

MANUFACTURED BY: ENGLAND STOVE WORKS INC. MONROE, VA 24574

You may write your unit's Manufacture Date and Serial Number in the blank spaces on this sample tag, for future reference. This sample tag also shows the safety info. such as UL testing standard, etc. for your local officials, or anyone else who may need reference information.

Have this information on hand if you phone the factory or your dealer regarding this product.

Retain for your files:

Model Number _____

Date of Purchase _____

Date of Manufacture _____ Serial # _____

LIMITED 5 YEAR WARRANTY FROM THE DATE OF PURCHASE TO THE ORIGINAL OWNER

The manufacturer extends the following warranties:

Five Year Period:

1. Carbon steel and welded seams in the firebox are covered for 5 years against splitting.
2. The cast iron door, hasp and hinges are covered for 5 years against cracking.

One Year Period:

3. Component parts such as damper and brick retainers are covered for 1 year against cracking, breakage and welded seams from separating.
4. Electrical components, accessory items, glass and the painted surface are covered for 1 year from the date of purchase.

Conditions and Exclusions:

Damage from over-firing will void your warranty.

This warranty does not apply if damage occurs because of an accident, improper handling, improper installation, improper operation, abuse, or unauthorized repair made or attempted to be made.

The manufacturer is not liable for indirect, incidental, or consequential damages in connection with the product including any cost or expense providing substitute equipment or service during periods of malfunction or nonuse.

All liability for any consequential damage for breach of any written or implied warranty is disclaimed and excluded. Some states do not allow the exclusion or limitations of incidental or consequential damages, so the above may not apply to you.

Procedure:

Purchaser must give notice of claim of defect within the warranty period and pay transportation to and from a service center designated by the factory. The dealer from which the unit was purchased or the factory, at our option, will perform the warranty service.

Other Rights:

This warranty gives you specific legal rights, and you may also have other rights, which may vary from state to state.

NOTE: THIS WARRANTY IS NULL AND VOID IF YOU DO NOT RETURN THE ATTACHED WARRANTY REGISTRATION WITH A COPY OF THE SALES RECEIPT WITHIN 30 DAYS FROM THE DATE OF PURCHASE. WARRANTY IS NOT TRANSFERABLE.

WARRANTY REGISTRATION for England's Stove Works

Purchased by (Name) _____

Address _____

City _____ State _____ Zip _____

Telephone _____

Email Address _____

DEALER INFORMATION

Purchased From (Dealer) _____

Address _____

City _____ State _____ Zip _____

UNIT INFORMATION

(Please be sure to refer to sticker on back of manual or box to complete this section)

Model Number _____ Purchase Date _____

Purchase Price _____

Serial Number _____ Mfg. Date _____

How did you first hear about our product? (please check one)

Word of Mouth Burn Trailer Demonstration Internet

Other: _____

Where did you receive information about our product? (please check one)

Rec'd. info. via phone Dealer (Name of dealer): _____

Internet Other: _____

IMPORTANT NOTICE

**THIS REGISTRATION INFORMATION MUST BE ON FILE FOR THIS WARRANTY TO BE VALID.
PLEASE MAIL THIS INFORMATION WITHIN THIRTY (30) DAYS FROM THE DATE OF PURCHASE.**

Mail To:

England's Stove Works, Inc.
Technical Support Department
P.O. Box 206
Monroe, VA 24574

Or, Fax To:

(434) 929-4810 – 24 hours a day

Or, now available – Go online to complete your Warranty Registration!

Visit www.englishstoves.com if you prefer to register online.