



INSTALLATION AND OPERATING INSTRUCTIONS

FOR

THE HARDY OUTSIDE WOOD BURNING HEATER

Model - H2, H3, H4 & H5

**HARDY MANUFACTURING
COMPANY, INC.**

12345 ROAD 505

PHILADELPHIA, MS 39350

PHONE: (601) 656-5866

FAX: (601) 656-4559

www.hardyheater.com



Rev. 03/13

Mountain View Hearth Products
manuals.stove-parts-unlimited.com

THIS PAGE INTENTIONALLY LEFT BLANK

INTRODUCTION

Thank you for purchasing the original all stainless steel Hardy Outside Wood-Fired Hydronic Heater. It represents the result of many years of Hardy experience and the input of Hardy customers in the production of a top quality heater. With the purchase of this Hardy Hydronic Heater, you can now appreciate the high degree of craftsmanship and reliability that have made The Hardy the leader in the Outside Wood-Fired Hydronic Heater field. This manual will provide you with a good basic understanding of the installation and operation of this heater.

THIS MANUAL INCLUDES IMPORTANT SAFETY INFORMATION.

Your new heater should have the following:

- (1) Owner's manual complete with Installation and Hook-Up Instructions
- (2) Warranty & Return Warranty Card
- (3) A tube of silicone (located in the firebox for shipping)
- (4) Smoke stack and condenser tank stack both with trim (located in the firebox for shipping)
- (5) H2 & H3 has two I-beams and three cast iron grates (located in the firebox)
H4 & H5 has one I-beam, two channels and six grates (located in the fire box)
- (6) Shovel (located in the firebox for shipping)
- (7) Stainless steel panel and insulation that will be located between the firebox door & ash door after installation of the heater
- (8) Stainless steel flame baffle (15" x 10"). Only for use on Hardy model H4 & H5

Should your heater not have any of these items or if you have any questions regarding the operation or maintenance of your heater, please consult you local Hardy dealer.

Again, thank you for purchasing a Hardy Outside Wood-Fired Hydronic Heater.

Sincerely,

Frank L. Moore
President
Hardy Manufacturing Company, Inc.

(MODEL H2, H3, H4, & H5)

Please fill in the following information

Hardy Model _____

Serial Number _____

Date of Purchase _____

Date of Installation _____

Dealer Purchased from _____

Dealer Address _____

Dealer Phone Number _____

HARDY MANUFACTURING COMPANY, INC.

12345 ROAD 505

PHILADELPHIA, MS 39350

PHONE: (601) 656-5866

www.hardyheater.com

(MODEL H2, H3, H4, & H5)

SAFETY PRECAUTIONS WARNING

Do not operate this equipment for other than its intended purpose nor other than in accordance with the instructions contained in this manual and all other instructions accompanying the unit. For units covered by this instruction book, it is important to observe safety precautions to protect yourself from possible injury. Among the many considerations, you are advised to:

- Observe all safety stickers on the unit.
- This unit must be wired by a qualified electrician in accordance with the National Electrical Code.
- Never use any type of petroleum product, petroleum based product, charcoal starter, lighter fluid, or any other flammable accelerant to start your unit.
- Always open the ash door (bottom) before you open the firebox door (top).
- Never leave the doors open, always latch the doors securely.
- Always use proper care when installing, operating and maintaining the unit.
- Do not modify the unit.
- Do not substitute repairs which can be provided by your dealer, distributor, or Hardy Manufacturing Company.

Failure to heed this warning or any additional warnings on the unit may result in an accident causing personal injury.

Safety Labels and Rating Labels

Read all safety labels on this unit
5" X 3.5"

HARDY MANUFACTURING CO., INC.			
12345 ROAD 505			
PHILADELPHIA, MISSISSIPPI		39350	
PHONE (601) 656-5866		84E4	
FOR OUTDOOR USE ONLY		 LISTED	
U.S. PATENT NO. 4360003		WOOD-FIRED HOT WATER HEATER	
HARDY OUTSIDE WOODBURNING FURNACE			
MODEL	H2-1-17	SERIAL NO.	[]
CAPACITY BTU/HR	120,000	DATE OF MFG.	2.5
ELECTRICAL RATING 115VAC/60 HZ/1P		[]	AMPS
MFS-15 AMP	MCA-15 AMP	TYPE OF FUEL-WOOD	
CLEARANCE TO COMBUSTIBLES			
TOP, REAR, & SIDES--18 INCHES		FRONT---48 INCHES	
CHIMNEY CONNECTOR-18 INCHES		FLOORING--NON-COMBUSTIBLE	

(MODEL H2, H3, H4, & H5)

Safety Labels

Read all safety labels on this unit

Name Plate Supplement
5" X 10" (not shown actual size)



CAUTION



- Do not connect this unit to a chimney flue servicing another appliance
- Hot surfaces
- Keep children and pets away
- Do not touch during operation



WARNING



- Risk of fire
- Do not use chemicals to start unit firing
- Do not burn garbage, gasoline, oil or other flammable liquids
- Do not operate with firebox or ash removal doors open
- Do not store fuel or other combustible material within marked installation clearances
- Inspect and clean flues and chimney regularly



DANGER



- Risk of fire or explosion
- Do not burn garbage, gasoline, oil or other flammable liquids

START UP AFTER LOSS OF POWER

- Unplug control and pump cords from GFCI receptacle
- Trip and reset the GFCI receptacle
- Verify the heater is full of water
- Open firebox door to verify if any coal or fire is still present (Refer to owners manual for start procedures)
- Plug in control and pump cords
- Verify that components operate
- Fill with required amount of wood
- Close the firebox door

RUN-AWAY FIRE PROCEDURE

- Close firebox and ash doors
- Unplug power cords from GFCI receptacle in back of unit
- Verify clean out and damper lids are closed
- Add water through the condenser

(MODEL H2, H3, H4, & H5)

Safety Labels

Read all safety labels on this unit

Heater Wiring Diagram 3" X 8"

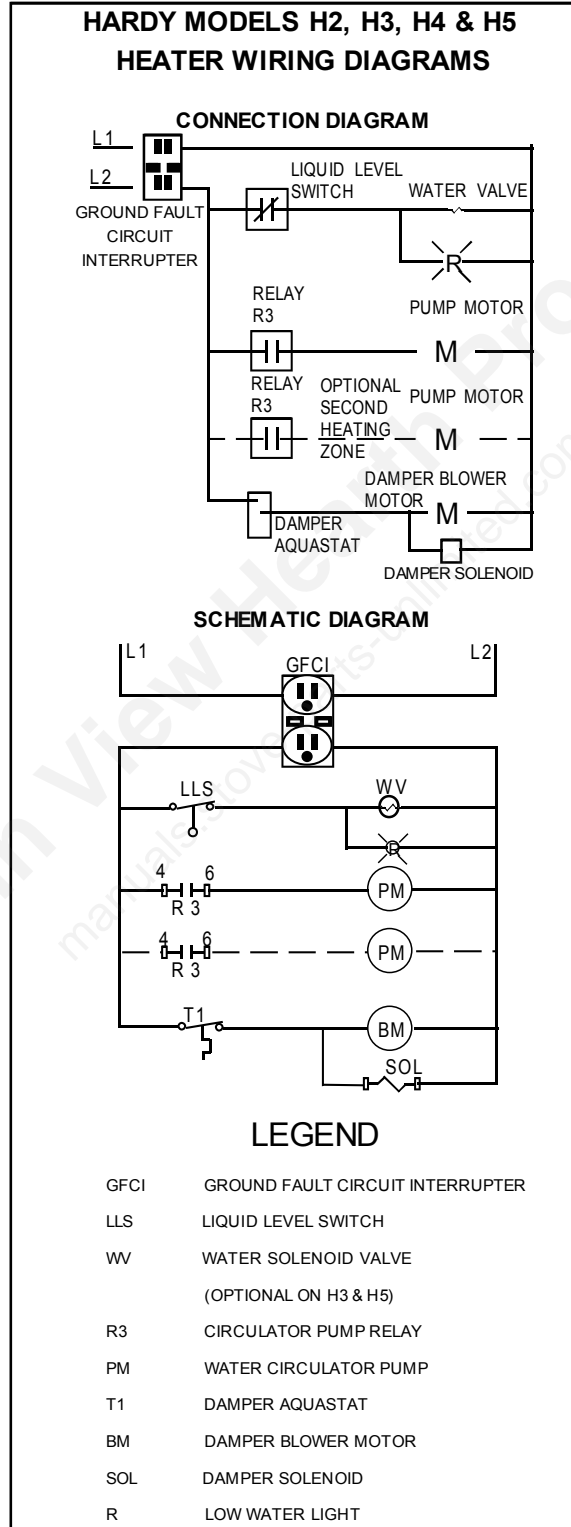

(MODEL H2, H3, H4, & H5)

Safety Labels

Read all safety labels on this unit

Warning label for Condenser Vent
5" X 3"



Back Door label
5" X 3"

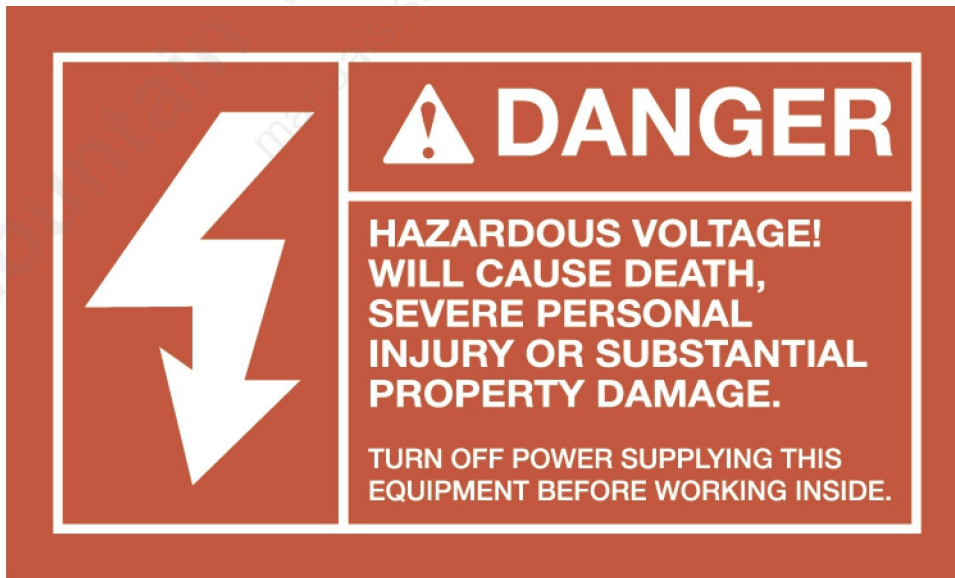

(MODEL H2, H3, H4, & H5)

Safety Labels

Read all safety labels on this unit

Warning label on front between doors
4" X 2 3/4"



Field wiring label
2 3/4" X 1"



Hot water label
2 3/4" X 1"



(MODEL H2, H3, H4, & H5)

Mountain View Hearth Products
manuals.stove-parts-unlimited.com

THIS PAGE INTENTIONALLY LEFT BLANK

OUTDOOR WOOD HEATER BEST BURN PRACTICES

1. Read and follow all operating instructions supplied by the manufacturer.
2. **FUEL USED:** Only those listed fuels recommended by the manufacturer of your unit. Never use the following: trash, plastics, gasoline, rubber, naphtha, household garbage, material treated with petroleum products (particle board, railroad ties and pressure treated wood), leaves, paper products, and cardboard.
3. **LOADING FUEL:** For a more efficient burn, pay careful attention to loading times and amounts. Follow the manufacturer's written instructions for recommended loading times and amounts.
4. **STARTERS:** Do not use lighter fluids, gasoline, or chemicals.
5. **LOCATION:** It is recommended that the unit be located with due consideration to the prevailing wind direction.
 - Furnace should be located no less than 100 feet from any residence not served by the furnace.
 - If located within 100 feet to 300 feet to any residence not served by the furnace, it is recommended that the stack be at least 2 feet higher than the peak of that residence.

Chimney Height Installation Scenario

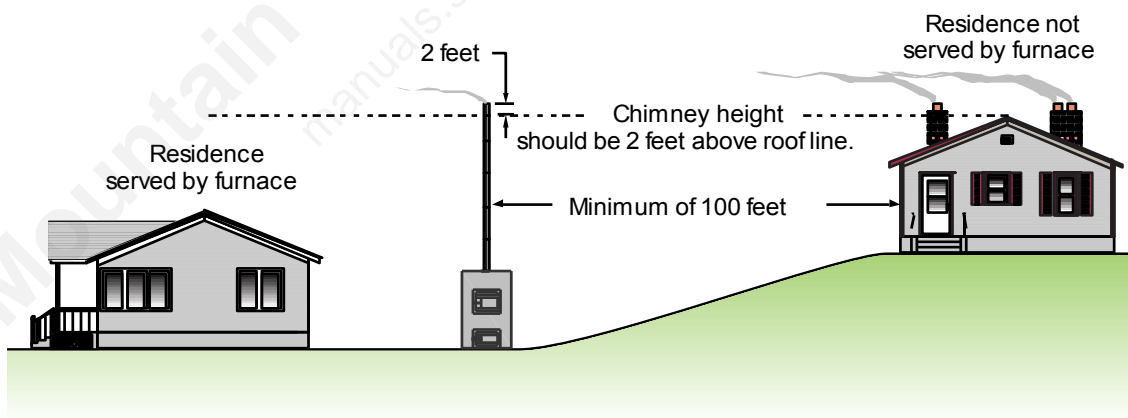

6. Always remember to comply with all applicable state and local codes.



OUTDOOR FURNACE MANUFACTURERS CAUCUS

(MODEL H2, H3, H4, & H5)

ix

THE HARDY OUTSIDE WOOD-FIRED HYDRONIC HEATER

How does an The Hardy heat my home?

The Hardy Outside Wood-Fired Hydronic heater is designed to save the most energy and provide the most comfortable heating available. It heats your home by heating a stainless steel tank filled with water, which surrounds the firebox of the outside heater. The heater is basically a non pressurized boiler with an atmospheric vent. This hot water is then circulated through underground hot water pipes to a water coil inside your existing central duct system. The Hardy Hydronic Heater can be connected to any existing hydronic heating system that operates at 180 degrees or less.

How does The Hardy heat water for household use?

A cold water supply line goes to the outside heater. This water line also keeps the water tank of the heater full. The heater only takes on water as it evaporates. The cold water line is connected to a heat exchanger which lies inside the water reservoir of the outside heater. The pressure on the supply line forces water through the heat exchanger when you open a hot water faucet inside your home. As this water passes through the heat exchanger it picks up the heat from the hot water that surrounds it and then goes to the cold side of your water heater. This means your water heater will take on hot water. This water is not contaminated with the water that passes through your heater and coil to heat your house.

How do the thermostat controls work?

The only visible addition to the heating system inside your home is the thermostat which is located near the existing thermostat. The two thermostats are installed so that if the outside wood heater is not in operation, your existing unit will automatically take over to maintain the household temperature. The wall thermostat which regulates the heat from the outside heater performs two functions; when it senses the need for heat, it turns the water pump on to circulate the hot water through the coil and also turns the blower on inside your central unit to force air across the hot coil. This forces hot air into your central duct system. The outside heater has a hot water thermostat which senses the water temperature of the unit. If the water is not as hot as the thermostat setting then the combustion air intake is automatically opened and remains open until such temperature is attained.

Where should The Hardy be located?

The outside unit should be located at least 10 feet from your home so that all fire danger is removed from your home. The unit may be installed as much as 100 feet away and still heat your house and hot water. If the unit is located more than 100 feet away, you may experience some heat loss on the water going to your hot water heater. Locate the heater where it will be convenient for refueling and wood storage. All water and power lines are installed underground between the house and the heater.

(MODEL H2, H3, H4, & H5)

x

TABLE OF CONTENTS

SECTION I: General Information	
1-1 Specifications	1-2
1-2 Heater Component Parts Model H2	3
1-3 Heater Component Parts Model H3	4
1-4 Heater Component Parts Model H4	5
1-5 Heater Component Parts Model H5	6
SECTION II: Installation of Heater	
2-1 Location of Heater	7-8
2-2 Chimney Connection	8
2-3 Hull Removal	9
2-4 Set-Up of Grates	10
2-5 Location of Plumbing & Electrical Lines	11
2-6 Connection of Power to Heater	12
2-7 Wiring Diagram	13
SECTION III: Plumbing Instructions	
3-1 Instructions for forced air systems	14
3-2 Location of heating coil	15-16
3-3 Instructions for Hydronic systems	17-18
3-4 Instructions for Domestic Water on H2/H4	19
3-5 Instructions for Domestic Water on H3/H5	20
3-6 Replacing Hull	21
3-7 Filling the Heater with water	22
SECTION IV: Connection to Central Heating/AC System	
4-1 Connection to Central Unit with Existing Blower Relay	23-24
4-2 Connection to Central Unit with Existing Blower Relay Diagram	25
SECTION V: Heater Operation	
5-1 Firing the Heater	26
5-2 Water Temperature	26
5-3 Moisture in the Firebox	26
5-4 Wood Usage	27
5-5 Improper Burning	27
5-6 Ash Removal	27
5-7 Ash Disposal	27
5-8 Creosote Formation and Removal	28

SECTION VI: **Service Information**

6-1 Electric Make-Up Water System.....29

6-2 Water Circulation System30

6-3 Temperature Control System31

SECTION VII: **Heater Maintenance**

7-1 Preventative Maintenance32

7-2 Preseason Maintenance33-34

7-3 In Season Maintenance34-35

7-4 Post Season Maintenance.....35

SECTION VIII: **Appendix**

8-1 General Trouble Shooting Guide36-43

8-2 Circulator Maintenance Instructions44-45

8-3 Damper Solenoid Replacement Instructions46

8-4 Low Water Switch Replacement Instructions47-48

8-5 Draft Blower Replacement Instructions49-50

8-6 Automatic water fill Replacement Instructions.....51-52

8-7 Aqua stat Replacement Instructions.....53-55

SECTION I

GENERAL INFORMATION

1-1 Specifications

Type of fuel – Clean Seasoned Hard Wood - Clean wood means wood that has no paint, stains, or other types of coatings, and wood that has not been treated with preservatives, including but not limited to, copper chromium arsenate, creosote, or pentachlorophenol.

For outdoor use only

Electrical Rating 115 VAC/ 60 HZ / 1PH
 MFS-15 AMP, MCA-15 AMP

Clearance to Combustibles

Top, Rear, Sides	18"
Chimney Connector	18"
Front	48"
Flooring	Non Combustible

Water Capacity

H2 & H3 – Holds Approximately 100 Gallons of Water
H4 & H5 – Holds Approximately 130 Gallons of Water

Heater Dimensions

Description	Width	Depth	Height	Weight
H2 & H3 – 120,000 BTU	30"	52 ½"	59 ½"	650 lbs.
H4 & H5 – 180,000 BTU	40"	52 ½"	59 ½"	850 lbs.

Firebox sizes

Description	Width	Depth	Height
H2 & H3 – 120,000 BTU	24"	32"	36" + 8" for Grates
H4 & H5 – 180,000 BTU	34"	32"	36" + 8" for Grates

Chimney

Description	Size OD	Material
H2 & H3 - 120,000 BTU	6"	Stainless Steel, Single wall
H4 & H5 - 180,000 BTU	8"	Stainless Steel, Single wall

1-1 Specifications

On the front of your heater there is a nameplate. Along with other information you will find the model number of your heater. This model number tells you what your heater rating is and what electrical and plumbing options your heater has, use the following list to determine this. The first section determines the rating of your heater. The second section determines electrical options. The last section determines the plumbing options. For example heater model number **H2-1-17**. The **H2** designates that you have a 120,000 BTU heater. The **1** in the second section designates that you have a standard pump. The **1** in the last section designates that you have domestic hot water coil. The **7** in the last section designates that you have extra ports on your heater.

Heater Rating

- H2 – 120,000 BTU
- H3 – 120,000 BTU
- H4 – 180,000 BTU
- H5 – 180,000 BTU

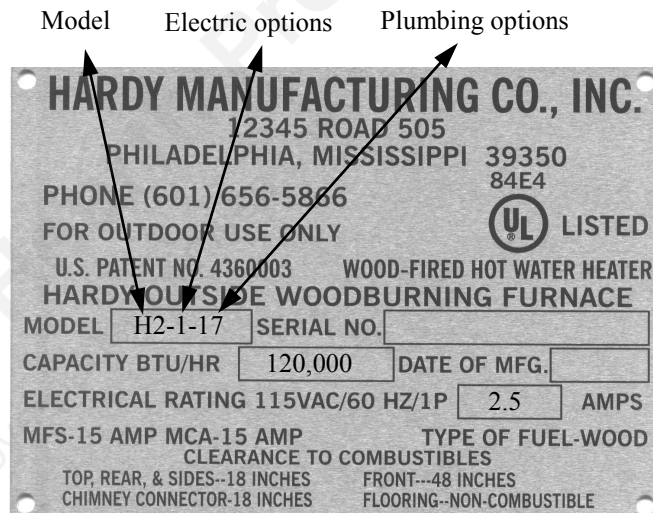

Electrical Options

- 0 – Without a Pump
- 1 – Standard Pump
- 2 – 2nd Pump & Relay
- 3 – 3rd Pump & Relay
- 4 – Without a Pump for Heating System and with Circulating Domestic Hot Water
- 5 – With a Standard Pump for Heating System and with Circulating Domestic Hot Water
- 6 – With 2nd Pump and Relay and with Circulating Domestic Hot Water
- 7 – With 3rd Pump and Relay and with Circulating Domestic Hot Water
- 8 - Optional External Plate & Circulator
- 9 - Optional automatic water fill

Plumbing Options

- 0 – Without Domestic Hot Water
- 1 – Standard Domestic Hot Water
- 2 – With 2nd Heat Exchanger (2nd Domestic Hot Water or Swimming Pool heat exchanger)
- 3 – With 3rd Heat Exchanger (2nd Domestic Hot Water and Swimming Pool Heat Exchanger)
- 4 – Extra 60' copper in Domestic Hot Water
- 5 – Extra 60' copper in Domestic Hot Water and Swimming Pool Heat Exchanger
- 6 – 1" Heat Exchanger –2 – 60' Rolls 3/4" Copper Manifold to 1" Ports
- 7 – Extra Ports, 1/2", 3/4", 1", etc.

1-2 Heater Component Parts Model H2

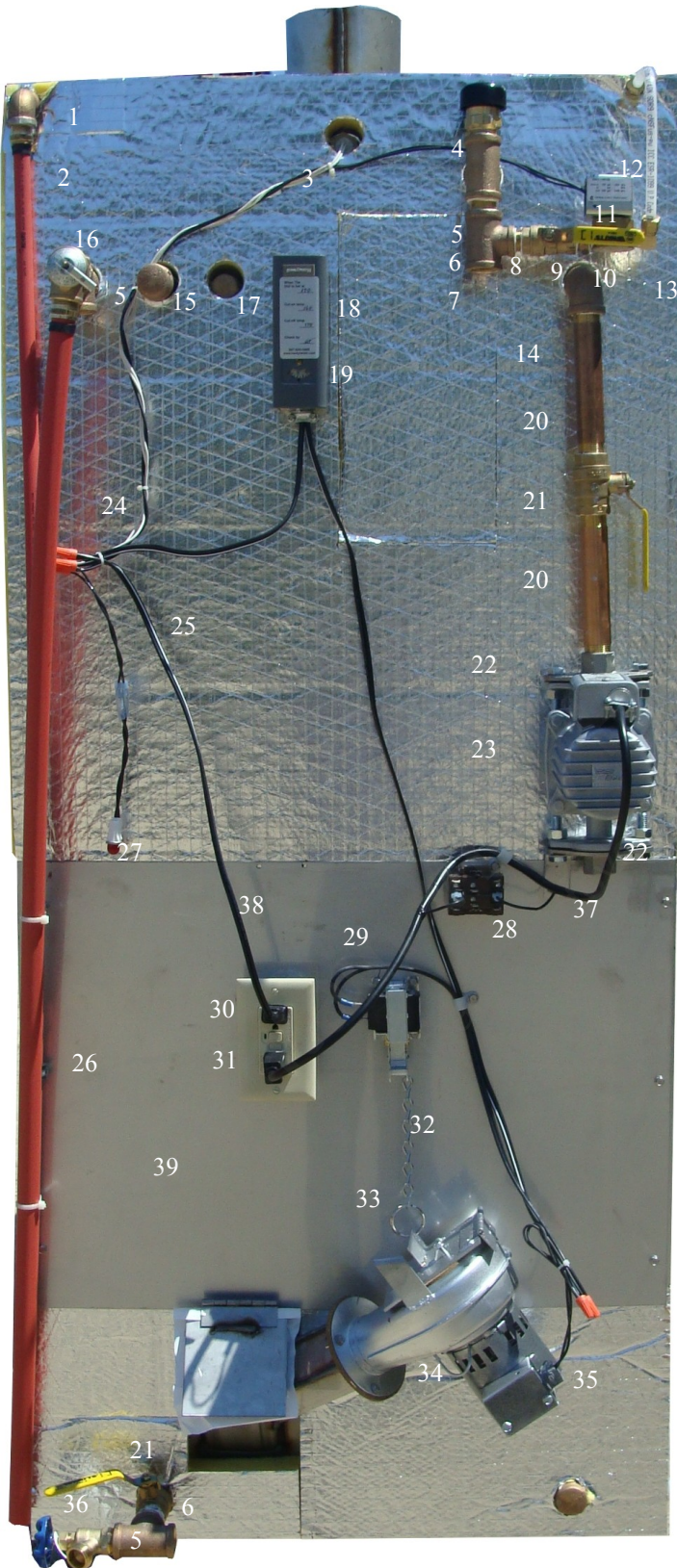

Part No.	Description
1	600.10 1/2" Brass Elbow
2	810.00 1/2" Overflow Pipe
3	1100.28 Low Water Switch
4	607.37 Vacuum Relief Valve
5	602.16 3/4" Brass Tee
6	603.40 3/4" x Close Brass Nipple
7	602.32 3/4" x 3/4" x 1/2" Brass Tee
8	603.08 1/2" x Close Brass Nipple
9	607.00 1/2" Brass Ball valve
10	605.00 1/2" x 1/4" Brass Bushing
11	1100.00 Electric Solenoid Valve
12	400.75 3/8" OD Pex fill line
13	600.57 3/8" comp x 1/4" mpt elbow
14	600.30 3/4" Brass Elbow
15	604.32 3/4" Brass Cap
16	607.30 3/4" T & P Valve
17	604.16 1/2" Brass Cap
18	2000.48 1/2" Well Fitting
19	2000.08 Honeywell Aqua stat
20	603.32 3/4" x 6" Brass Nipple
21	607.12 3/4" Brass Ball Valve
22	502.60 3/4" SS flange
23	502.50 Taco 009 SS Circulator
24	810.10 3/4" T&P Relief Pipe
25	2004.40 Wire Connectors
26	810.15 5/8" Clamp
27	1100.30 Low Water Light
28	2000.52 Honeywell Relay
29	2001.05 Damper Solenoid
30	2004.00 GFCI Receptacle
31	2004.16 Receptacle box 2 1/8" deep
32	3200.12 Jack Chain
33	3200.16 Key Ring
34	2002.16 100 CFM Blower / Lid
35	2004.28 Plastic Romex Connector
36	607.42 3/4" Boiler Drain
37	2004.04 3' 3 Wire Power Cord
38	2004.08 8' 2 Wire Power Cord
39	2004.52 Electrical Mounting Panel

1-3 Heater Component Parts Model H3

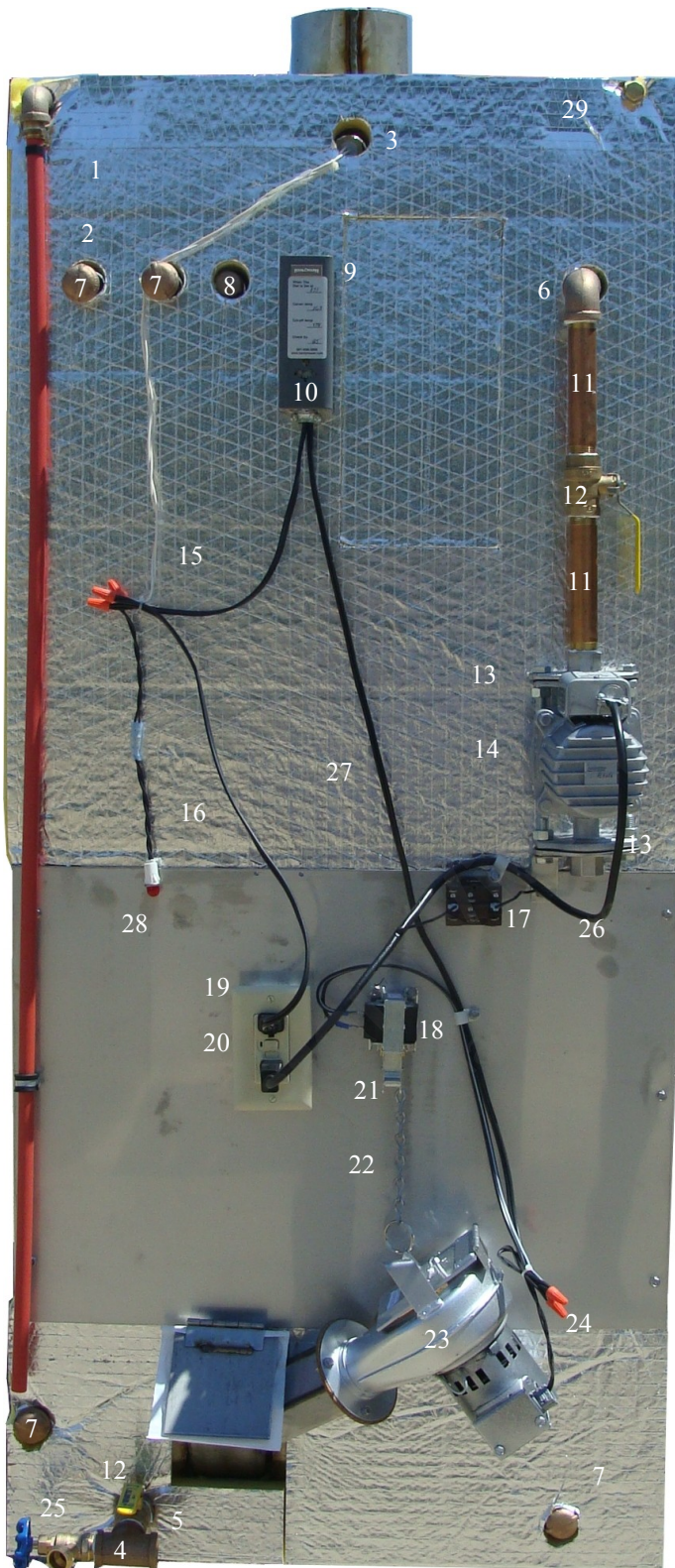

Part No.	Description
1	600.10 1/2" Brass Elbow
2	810.00 1/2" Overflow Pipe
3	1100.28 Low Water Switch
4	602.16 3/4" Brass Tee
5	603.40 3/4" x Close Brass Nipple
6	600.30 3/4" Brass Elbow
7	604.32 3/4" Brass Cap
8	604.16 1/2" Brass Cap
9	2000.48 1/2" Well Fitting
10	2000.08 Honeywell Aqua stat
11	603.32 3/4" x 6" Brass Nipple
12	607.12 3/4" Brass Ball Valve
13	502.60 3/4" SS flange
14	502.50 Taco 009 SS Circulator
15	2004.40 Wire Connectors
16	1100.30 Low Water Light
17	2000.52 Honeywell Relay
18	2001.05 Damper Solenoid
19	2004.00 GFCI Receptacle
20	2004.16 Receptacle box 2 1/8" deep
21	3200.12 Jack Chain
22	3200.16 Key Ring
23	2002.16 100 CFM Blower / Lid
24	2004.28 Plastic Romex Connector
25	607.42 3/4" Boiler Drain
26	2004.04 3' 3 Wire Power Cord
27	2004.08 8' 2 Wire Power Cord
28	2004.52 Electrical Mounting Panel
29	604.00 1/4" Brass Cap

1-4 Heater Component Parts Model H4

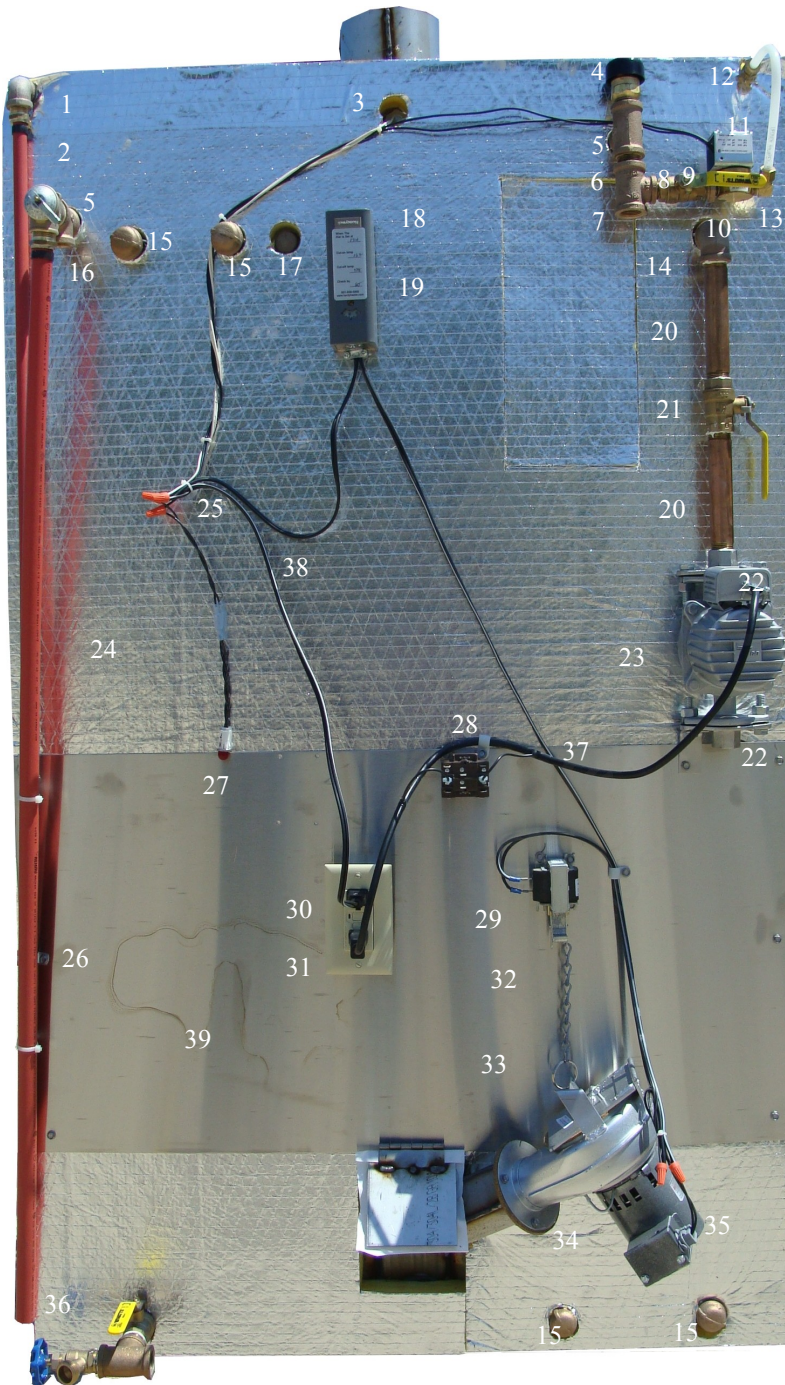

Part No.	Description
1	600.10 1/2" Brass Elbow
2	810.00 1/2" Overflow Pipe
3	1100.28 Low Water Switch
4	607.37 Vacuum Relief Valve
5	602.16 3/4" Brass Tee
6	603.40 3/4" x Close Brass Nipple
7	602.32 3/4" x 3/4" x 1/2" Brass Tee
8	603.08 1/2" x Close Brass Nipple
9	607.00 1/2" Brass Ball valve
10	605.00 1/2" x 1/4" Brass Bushing
11	1100.00 Electric Solenoid Valve
12	400.75 3/8" OD Pex fill line
13	600.57 3/8"comp x 1/4" mpt elbow
14	600.30 3/4" Brass Elbow
15	604.32 3/4" Brass Cap
16	607.30 3/4" T & P Valve
17	604.16 1/2" Brass Cap
18	2000.48 1/2" Well Fitting
19	2000.08 Honeywell Aqua stat
20	603.32 3/4" x 6" Brass Nipple
21	607.12 3/4" Brass Ball Valve
22	502.60 3/4" SS flange
23	502.50 Taco 009 SS Circulator
24	810.10 3/4" T&P Relief Pipe
25	2004.40 Wire Connectors
26	810.15 5/8" Clamp
27	1100.30 Low Water Light
28	2000.52 Honeywell Relay
29	2001.05 Damper Solenoid
30	2004.00 GFCI Receptacle
31	2004.16 Receptacle box 2 1/8" deep
32	3200.12 Jack Chain
33	3200.16 Key Ring
34	2002.28 130 CFM Blower / Lid
35	2004.28 Plastic Romex Connector
36	607.42 3/4" Boiler Drain
37	2004.04 3' 3 Wire Power Cord
38	2004.08 8' 2 Wire Power Cord
39	2004.52 Electrical Mounting Panel

1-5 Heater Component Parts Model H5

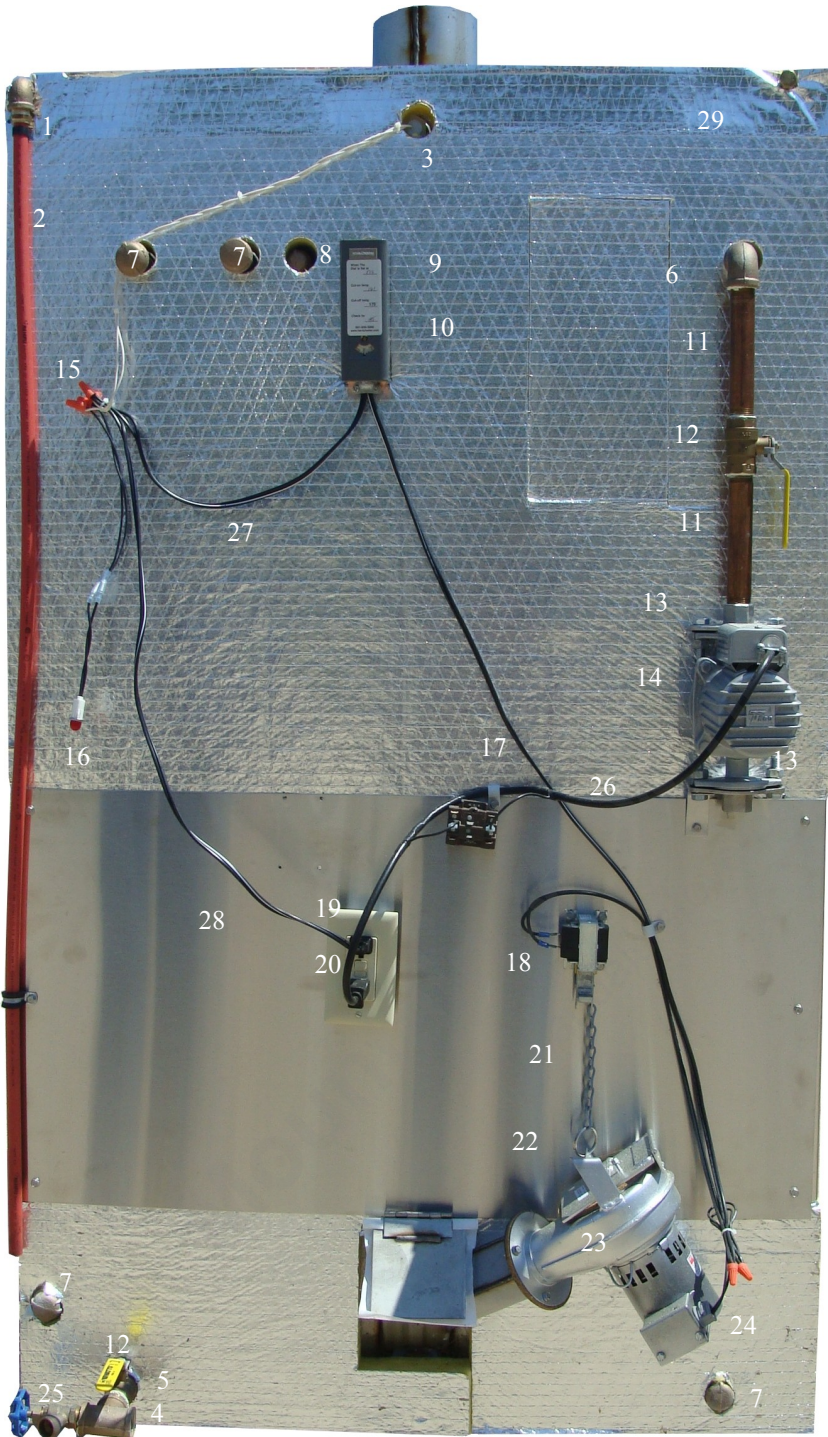

Part No.	Description
1	600.10 1/2" Brass Elbow
2	810.00 1/2" Overflow Pipe
3	1100.28 Low Water Switch
4	602.16 3/4" Brass Tee
5	603.40 3/4" x Close Brass Nipple
6	600.30 3/4" Brass Elbow
7	604.32 3/4" Brass Cap
8	604.16 1/2" Brass Cap
9	2000.48 1/2" Well Fitting
10	2000.08 Honeywell Aqua stat
11	603.32 3/4" x 6" Brass Nipple
12	607.12 3/4" Brass Ball Valve
13	502.60 3/4" SS flange
14	502.50 Taco 009 SS Circulator
15	2004.40 Wire Connectors
16	1100.30 Low Water Light
17	2000.52 Honeywell Relay
18	2001.05 Damper Solenoid
19	2004.00 GFCI Receptacle
20	2004.16 Receptacle box 2 1/8" deep
21	3200.12 Jack Chain
22	3200.16 Key Ring
23	2002.16 100 CFM Blower / Lid
24	2004.28 Plastic Romex Connector
25	607.42 3/4" Boiler Drain
26	2004.04 3' 3 Wire Power Cord
27	2004.08 8' 2 Wire Power Cord
28	2004.52 Electrical Mounting Panel
29	604.00 1/4" Brass Cap

SECTION II

INSTALLATION OF HEATER

2-1 Location of Heater

The Hardy Hydronic Heater must be located outside the building to be heated. The unit must be located a minimum of 10 feet from the building. The unit should be installed upon a concrete pad. There are two typical installation options that we recommend.

Option 1 has the unit installed on concrete pad with the rear of the water tank flush with the end of the pad. We recommend the pad to be 48" wide and 53" long minimum. If you add extra length it will allow ample concrete in front of the heater for loading wood and removing ashes. The space between the rear of the unit and the outside cover will allow a 4" watertight pipe or other means to insulate the plumbing and electrical lines to run directly into the ground. The outside cover can be removed by lifting it off the water tank on all four corners. This will allow you easy access for the connection of the plumbing and electrical lines.

Please see the illustration below for details.

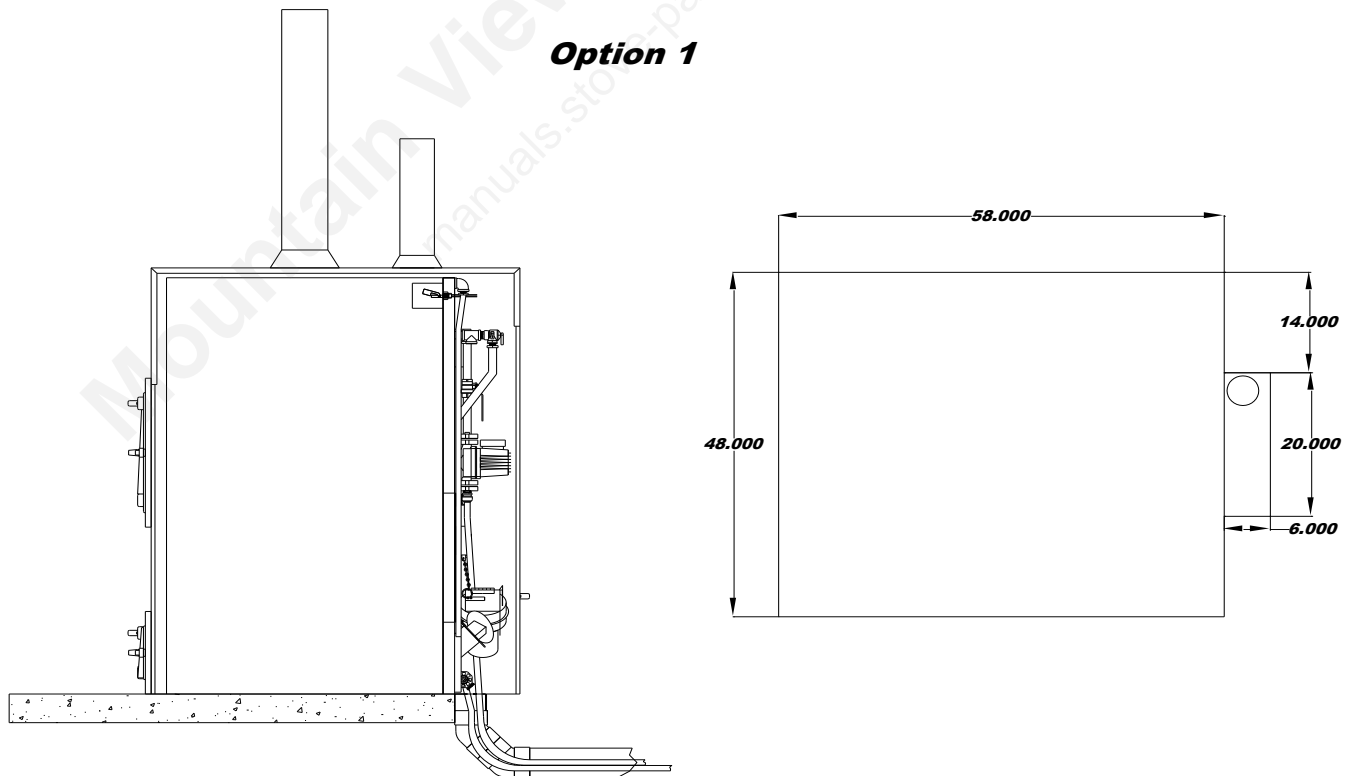

2-1 Location of Heater (continued)

Option 2 illustrates the unit installed on a concrete pad with cut out in the pad for plumbing and electrical lines to run through. We recommend this pad to be 48" wide by 60" long minimum. If you add extra length it will allow ample concrete in front of the heater for loading wood and removing the ashes. The 4" watertight pipe or other means to insulate plumbing that runs underground exits through this cut out to allow connections to the unit. The unit sits on the pad with the rear of the water tank flush or even with the front side of the cutout. The outside cover of the heater can be removed by lifting it from the water tank on all four corners. This will allow you easy access for the plumbing and electrical connections.

Please see the illustration below for details.

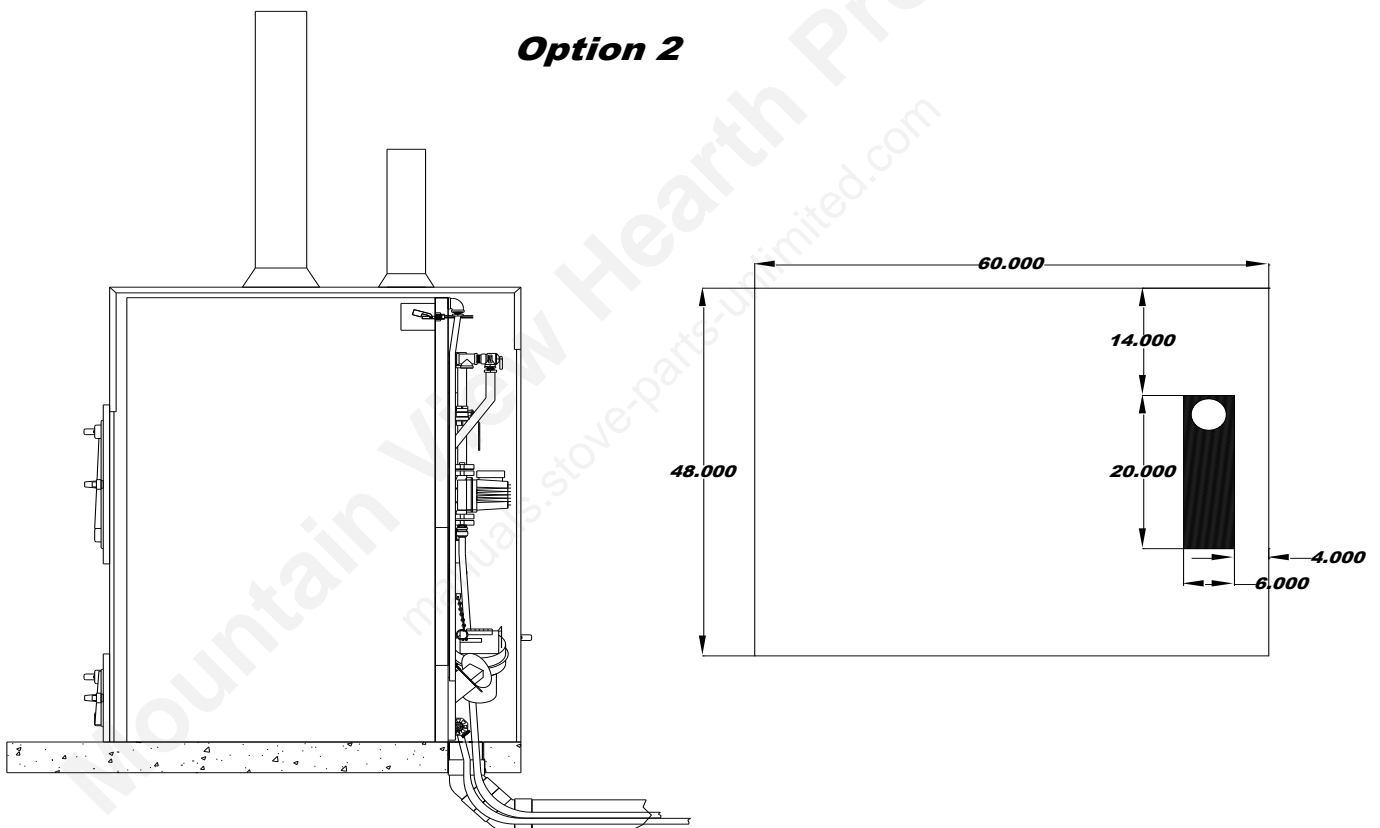

2-2 Chimney Connection

Do not connect this unit to a chimney flue serving another appliance.

2-3 Hull Removal

After placing your new Hardy Hydronic Heater upon the concrete pad, you are ready to continue the installation process. There are two methods to gain access to the rear of the heater to make plumbing and electrical connections.

The first and easiest method is to remove the screw holding the back door panel in place. The door is easily removed by lifting up on the handle and taking it out. With the back door removed, using a 5/16" wrench, remove the eight metal screws that are located below the back door. There are four on each side that hold the panel in place. After the screws are removed, the panel should come out easily and allow access to the bottom of the unit to make plumbing and electrical connections.

The second method is the removal of the entire cover. With the back door, the rectangular piece of stainless, insulation between the fire box and ash doors removed, and unplug the low water light, the outside cover can be lifted up and off as seen in the picture. To replace the cover simply repeat these steps in reverse order.

Please see the illustration below for details.



Rear View



Front View

2-4 Set-Up of Grates

On the Hardy models H2 & H3, open the firebox door and remove everything from inside of the heater except the two I-beams and three grates. Stand the two I-beams up on the edge and slide over against the tabs on either side of the ash pan. The grates can now be placed on the I-beams in line and side to side. The picture below shows the proper way for grates to be set on the I-Beams.

These grates are designed to be turned over if they warp.

On Hardy H4 & H5 models there will be two channel beams and one I-beam with the ends cut at a 45 degree angle. There will also be six grates. Stand the channel beams on edge with the open side to the inside, and slide them over against the sides of the firebox. The I-beam will need to be set on edge with the longer edge on top and placed in the center of the firebox. The grates may then be placed on either side of the I-beam across to the channel beams, three to a side. See the picture below for proper set-up.

There is also a stainless steel flame baffle (15" x 10") in the H4 & H5 heaters. This flame baffle is inserted in the firebox across the 3/4" stainless steel pipes located directly below the smoke stack.

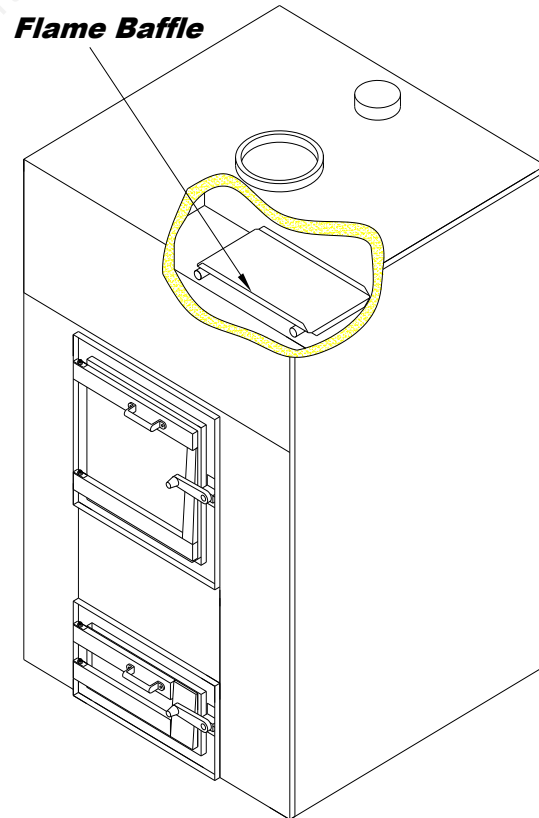

2-5 Location of Plumbing and Electrical Lines

The plumbing and electrical lines for your unit must be installed underground. The water lines must be buried below the frost line to prevent freezing. The depth of the trench varies to different regions of the country. Be completely sure about the correct depth before the plumbing lines are installed underground. A trench must be dug wide enough to accommodate a 4" watertight pipe or other insulation means. All plumbing and electrical lines should be run inside the 4" watertight pipe or other insulation means for a standard installation. If more than one zone is to be heated or more than one location is to be heated then an additional pipe, or insulation must be installed underground. This pipe will run from the rear of the unit to the location to be heated. Inside the 4" watertight pipe will be the four water lines, thermostat wire, and electrical supply wire. The listing below describes each line and their function.

1. One cold water supply line (if heater has auto fill option).
2. One hot water return line to water heater (if heater has internal domestic water heat exchanger).
3. One water supply line to heating system.
4. One water return line from heating system
(All of these must be at least 3/4" pipe and may require 1" because of longer distances or some hydronic applications).
5. One 3 conductor thermostat wire.
6. One #12/2 W/G UF underground Romex wire.



2-6 Connection of Power to Heater

This unit must be wired by a qualified electrician in accordance with the National Electrical Code.

The #12/2 W/G UF wire is run from the electrical system in the house through the 4" watertight pipe or other insulation means to the heater.

This wire will connect to the Ground Fault Circuit Interrupter (GFCI) on the back of the heater.

Install a Romex Connector in the bottom of the electrical makeup box, and insert Romex wire through this connector.

Connect the black wire to the brass screw on the line side of the GFCI receptacle.

Connect the white wire to the silver screw on the line side of the GFCI receptacle

Connect the bare copper wire to the green screw on the GFCI receptacle.

After the wiring is complete, and power is applied, check the receptacle with a circuit tester to determine if the polarity is correct, and to make sure the ground is connected. Press the test button on the GFCI receptacle. The reset button should pop out indicating the interrupter is operating correctly. Push the reset button back to restore the GFCI receptacle to normal operation. This test should be done monthly to insure safe operation of the heater.

If moisture is allowed into the Ground Fault Circuit Interrupter box, it will have a tendency to trip unwarranted. Measures should be taken to keep the box dry.

2-7 Wiring Diagram

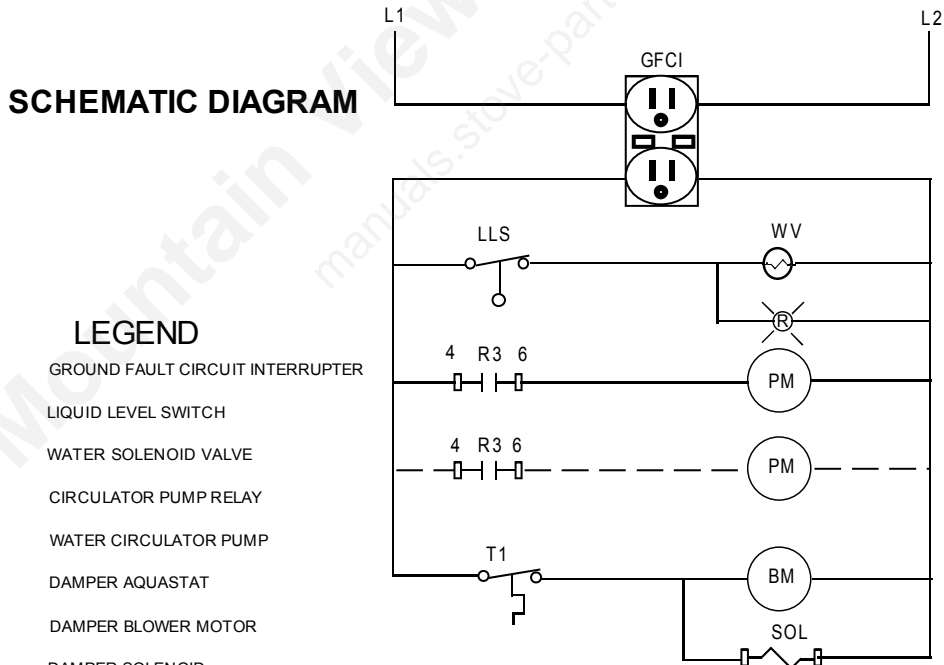
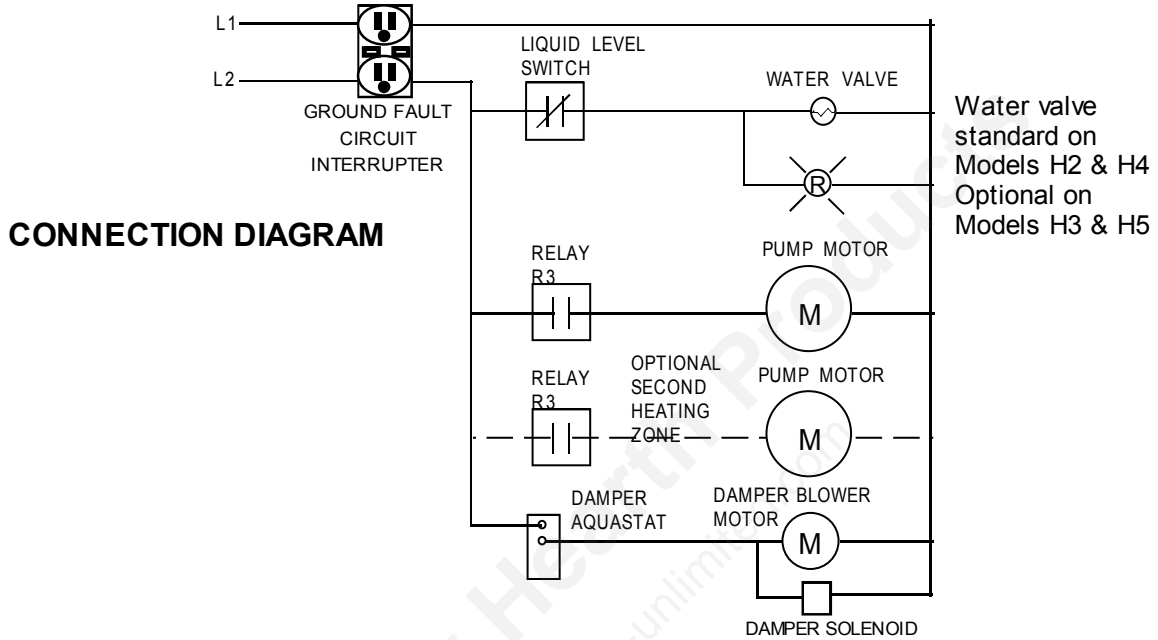

LEGEND

GFCI	GROUND FAULT CIRCUIT INTERRUPTER
LLS	LIQUID LEVEL SWITCH
WV	WATER SOLENOID VALVE
R3	CIRCULATOR PUMP RELAY
PM	WATER CIRCULATOR PUMP
T1	DAMPER AQUASTAT
BM	DAMPER BLOWER MOTOR
SOL	DAMPER SOLENOID
R	LOW WATER LIGHT

SECTION III

PLUMBING INSTRUCTIONS

3-1 Instructions for Forced Air Systems

The pipe that will supply the heating system is connected to the under side of the pump. This pump is located on the right hand side of the heater (noted by # 3 in diagram.)

The pipe that will carry the return water from the heating system is connected to the 3/4" brass tee located at the bottom left hand corner of the heater (noted by # 4 in diagram).

These two (2) lines will go to the heat exchanger coil that mounts into the duct work of your forced air heating system. For best results connect the line from the pump to the fitting of the heat exchanger closest to the side of the heat exchanger that the air is leaving. Connect the return line to the heat exchanger on the side that the air is entering.

Water pipes must be designed for hot water service (ex. copper, cpvc, or Pex.) Pipes should be installed in a 4" watertight pipe or some other type of insulating means to prevent heat loss from heater to heating system. Use only copper, brass, or stainless steel fittings. Do not use galvanized or black iron.

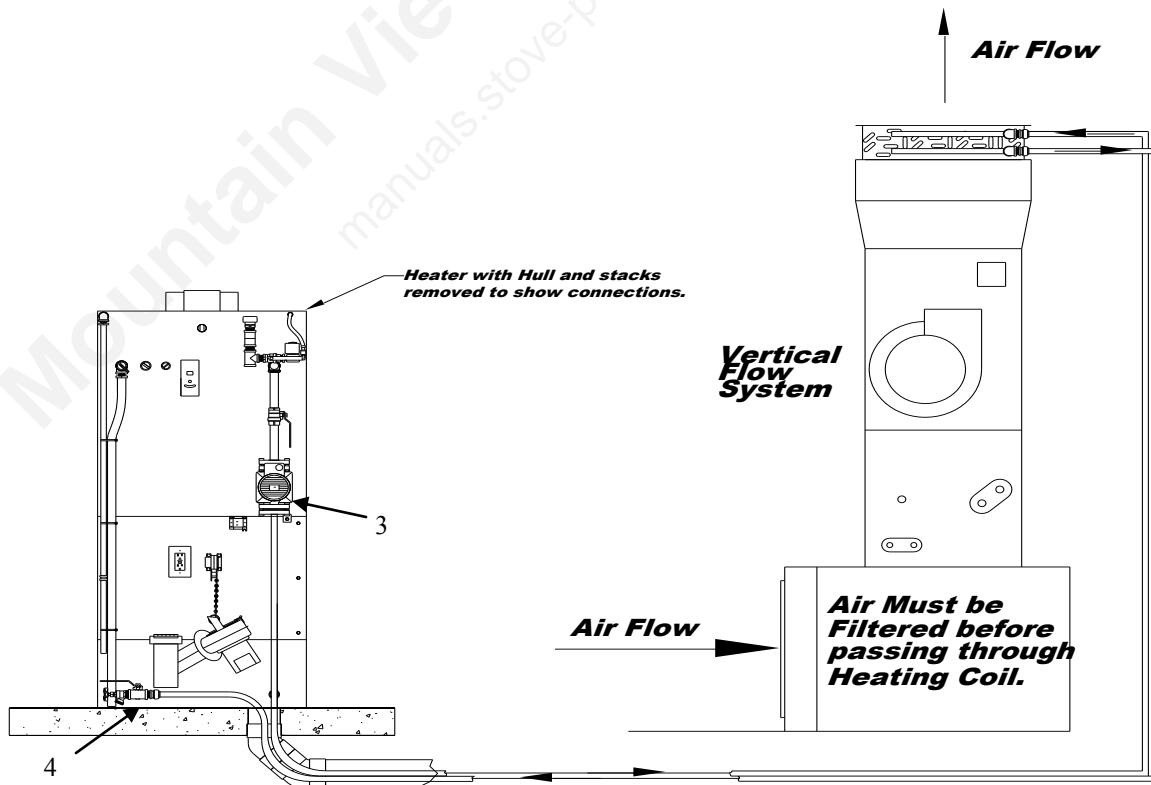

3-2 Location of Heating Coil

The following diagrams on this page and the following page show various methods of installing the heating coil in a forced air system.

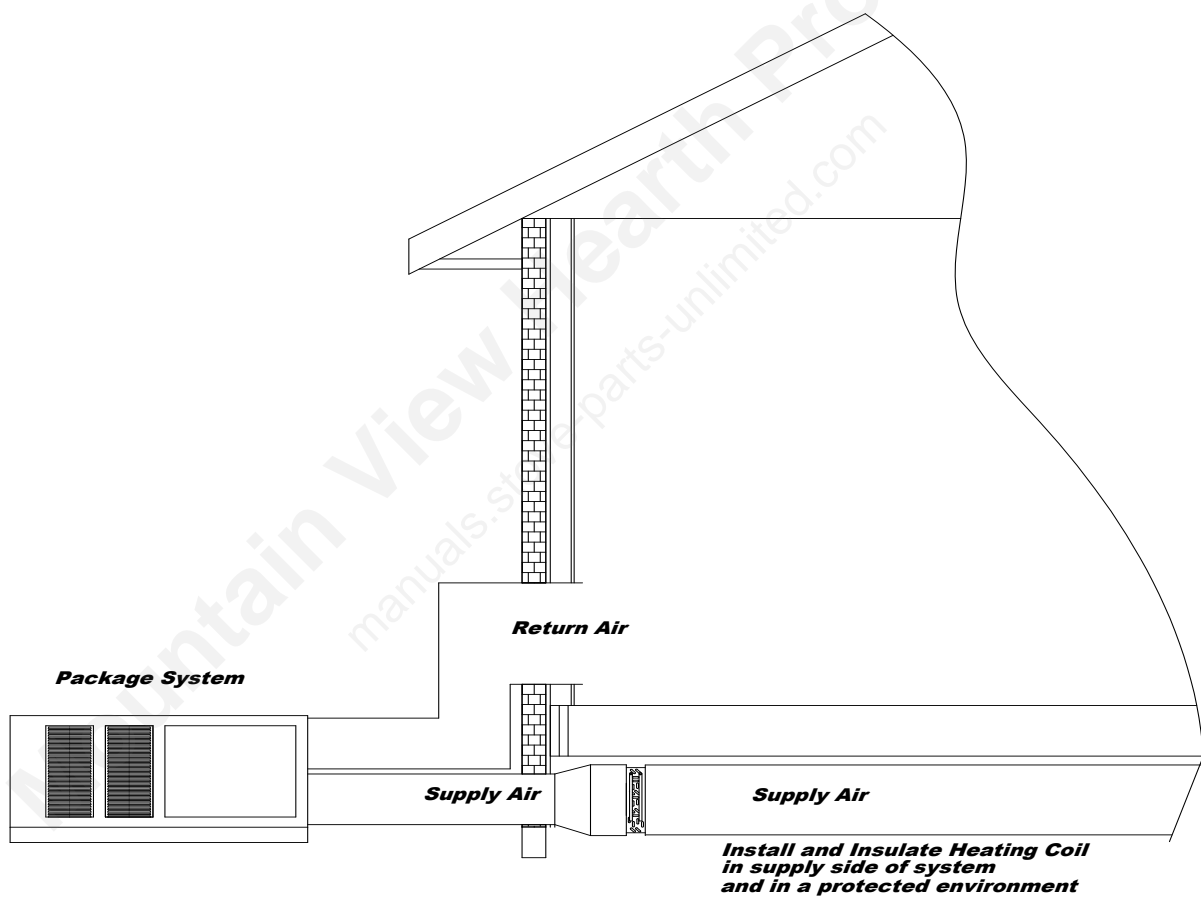

3-2 Location of Heating Coil (continued)

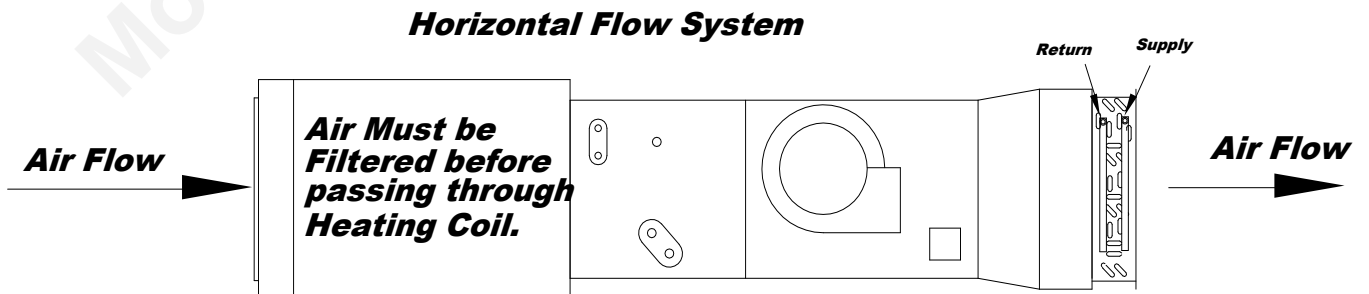
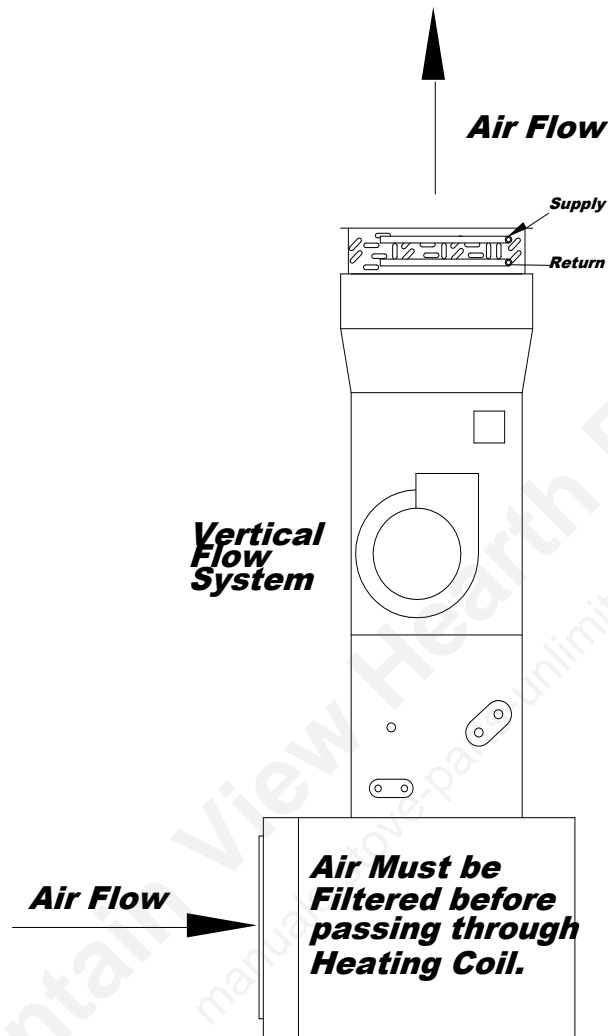

3-3 Instructions for Hydronic systems

The preferred method for connecting the Hardy Hydronic Heater to an existing Hydronic system is by installing a p/n 300.01- 40 plate heat exchanger with 1" fittings into the return line of the existing boiler system. This will allow the existing boiler to remain a pressurized system. This can be done by installing a shutoff valve and two bypass lines in the heating systems return line. Install service valves into each of the bypass lines. (Refer to diagram below).

Run two -1" hot water lines (suitable for continuous flow) from the pump and return of the heater to the existing boiler system. Connect these lines to the plate heat exchanger so that the water flow of the heater is opposite of that from the boiler system. Bypass the relay on the pump to allow the pump on the heater to run continuous.

Water pipes must be designed for hot water service (ex. copper, cpvc, or Pex.) Pipes should be installed in a 4" watertight pipe or some other type of insulating means to prevent heat loss from heater to heating system. Use only copper, brass, or stainless steel fittings. Do not use galvanized or black iron.

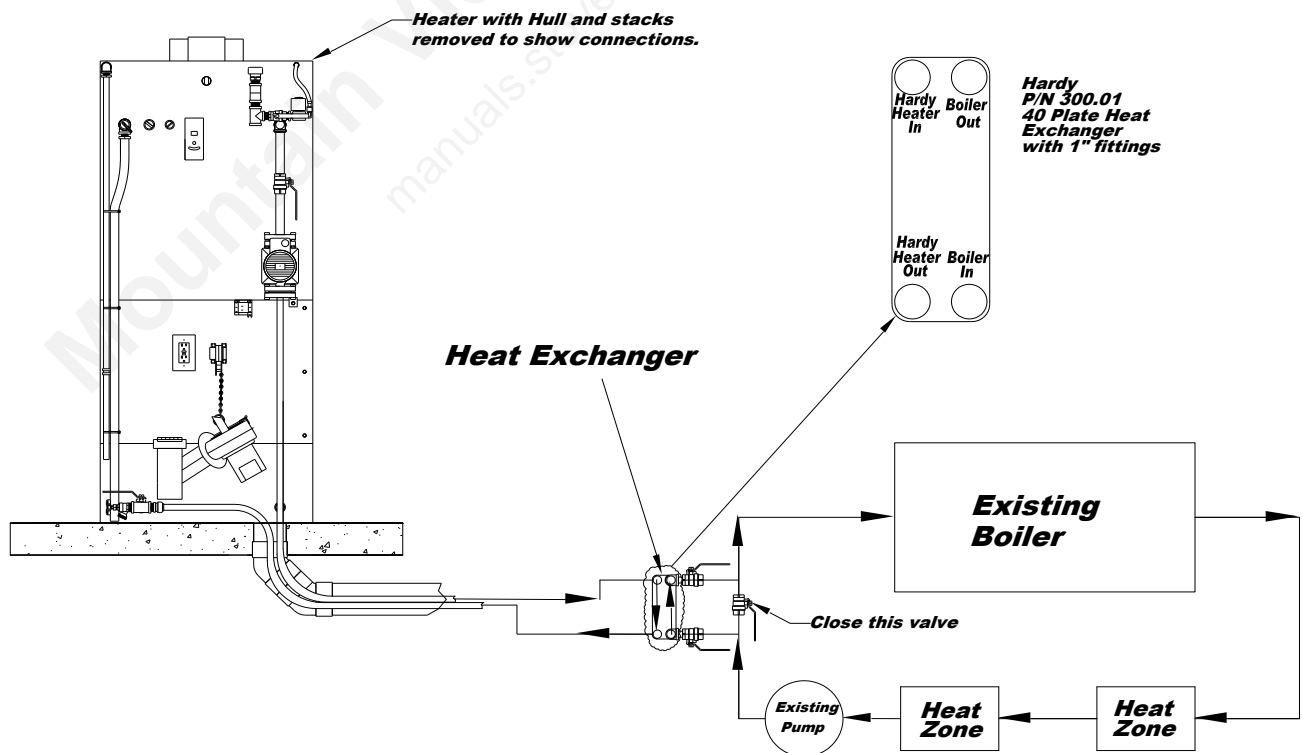

3-3 Instructions for Hydronic systems (continued)

**This unit must be wired by a qualified electrician
in accordance with the National Electrical Code.**

Using a new 24 volt transformer, a new 24 volt relay, and a low voltage wall thermostat the following wiring diagram shows how to modify the existing boiler aqua stat wiring. By adding a normal open circuit into the existing aqua stat wiring you can leave the boiler aqua stat set at the original factory setting. Set the new low voltage wall thermostat approximately 3 degrees below the home heat thermostat. If the heater were to get behind for any reason the boiler can come on and help maintain the home temperature.

Wiring to add Hardy Hydronic Heater
to existing hydronic heating system.

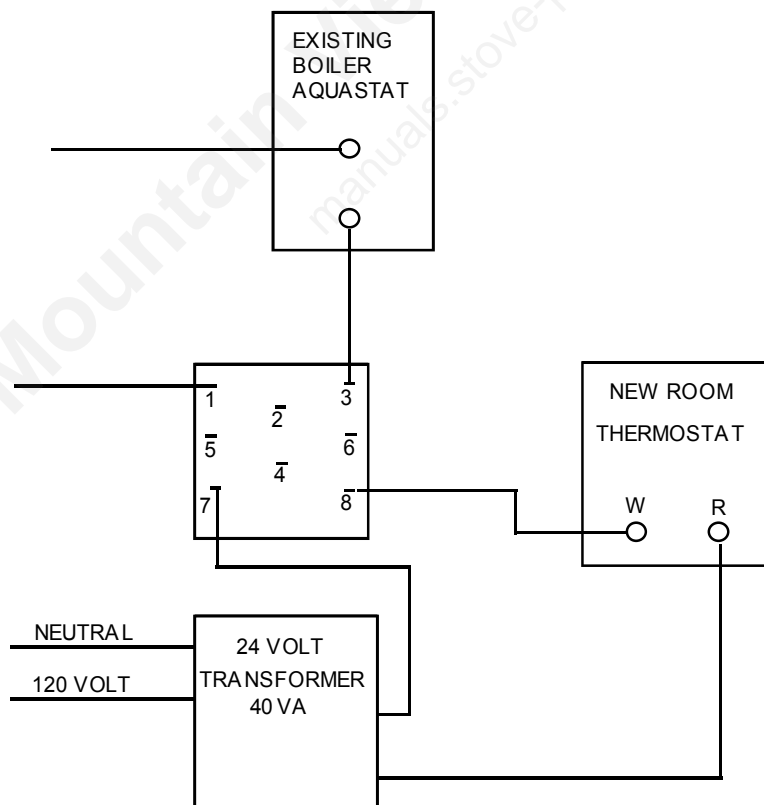

3-4 Instructions for Domestic Water on H2/H4

1. The cold water supply to your Hardy Hydronic Heater can be picked up from the cold water line supplying your existing water heater. This can be accomplished by inserting a tee into the existing cold water line. Directly below this tee you will need to insert a valve to stop cold water from entering the water heater. Another cold water supply may be used that is closer or more accessible to the heater.
2. The hot water supply line from the Hardy Hydronic Heater is connected into the existing water heater by teeing it into the cold water supply line below the valve that was installed in step 1. If you picked up your cold water supply elsewhere, then a valve will need to be inserted above the tee for the hot water supply.

Water pipes must be designed for hot water service (ex. copper, cpvc, or Pex.) Pipes should be installed in a 4" watertight pipe or some other type of insulating means to prevent heat loss from heater to heating system. Use only copper, brass, or stainless steel fittings. Do not use galvanized or black iron.

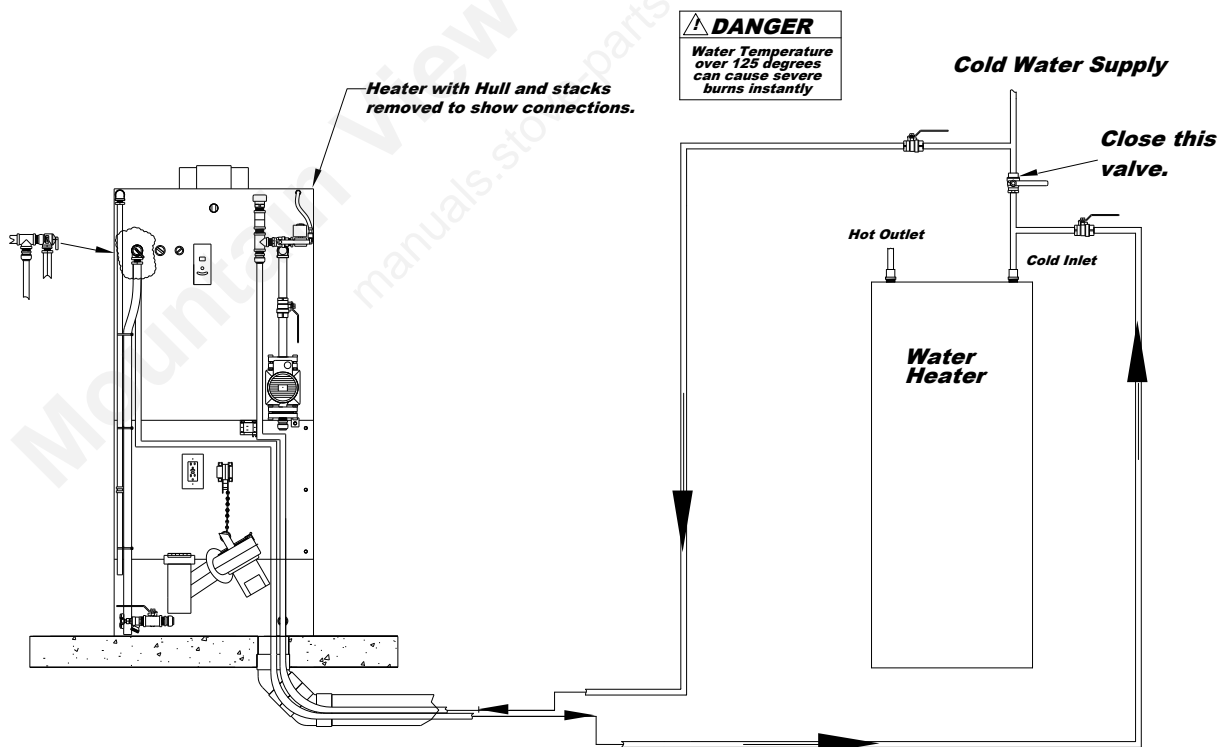

3-5 Instructions for Domestic Water on H3/H5

A plate heat exchanger and pump can be added to the Hardy Hydronic Heater to add domestic hot water to the Models H3 & H5. This plate heat exchanger will provide preheated water to the domestic hot water. The preferred method is to mount a plate heat exchanger at the water heater and connect it as shown in the following diagram. The pump will circulate heater water through the plate continuously. The cold water supply will need to be connected to the opposite side of the plate heat exchanger and flowing in the opposite direction for maximum efficiency. The alternate method would be to mount the plate heat exchanger on the back of the heater and connect the water heater to the plate the same way as in the preferred method with counter flowing waters.

Water pipes must be designed for hot water service (ex. copper, cpvc, or Pex.) Pipes should be installed in a 4" watertight pipe or some other type of insulating means to prevent heat loss from heater to heating system. Use only copper, brass, or stainless steel fittings. Do not use galvanized or black iron.

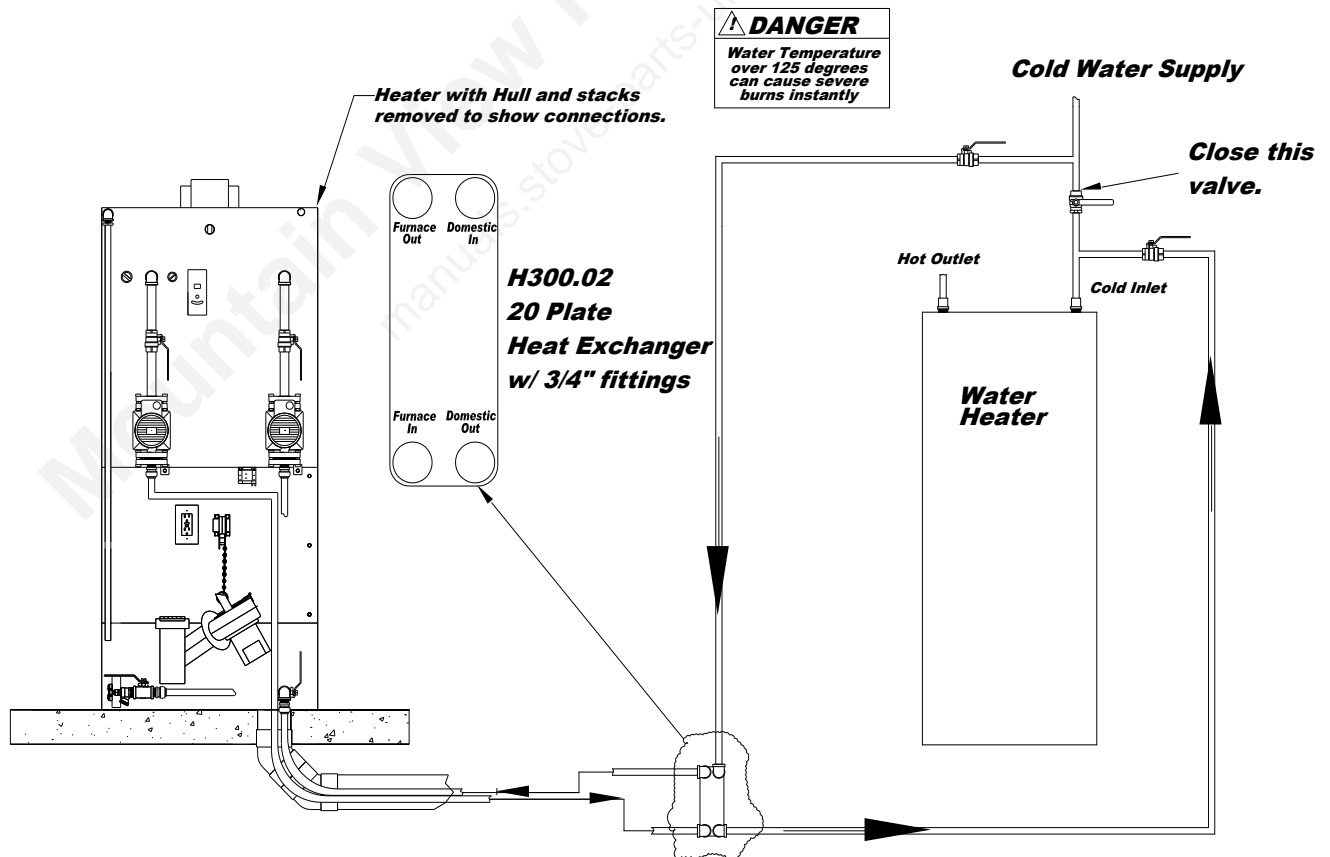

3-6 Replacing Hull

If you removed the hull to aid in plumbing the back of the heater it is time to place the hull back on the heater. The space between the smoke stack ring and outside cover will need a bead of silicone applied to fill any openings. The condenser tank will also need to be sealed in this manner. The application of silicon to these openings is illustrated by the diagram and pictures below. After these steps, you can install the smoke stack. The trim should slide down the smoke stack until it sits on the outside cover. The condenser stack must also be installed in the condenser tank opening. The trim should slide down the condenser stack until it sits on the outside cover. You should have a piece of insulation and a stainless steel plate that you removed from the inside of the firebox earlier. This will install between the firebox door and the ash door. The insulation fits between the doors and the stainless steel plate will slide behind the door frames across the outer hull.

Do not seal the condenser tank to the condenser tank stack. This is the water tank vent and must not be sealed.

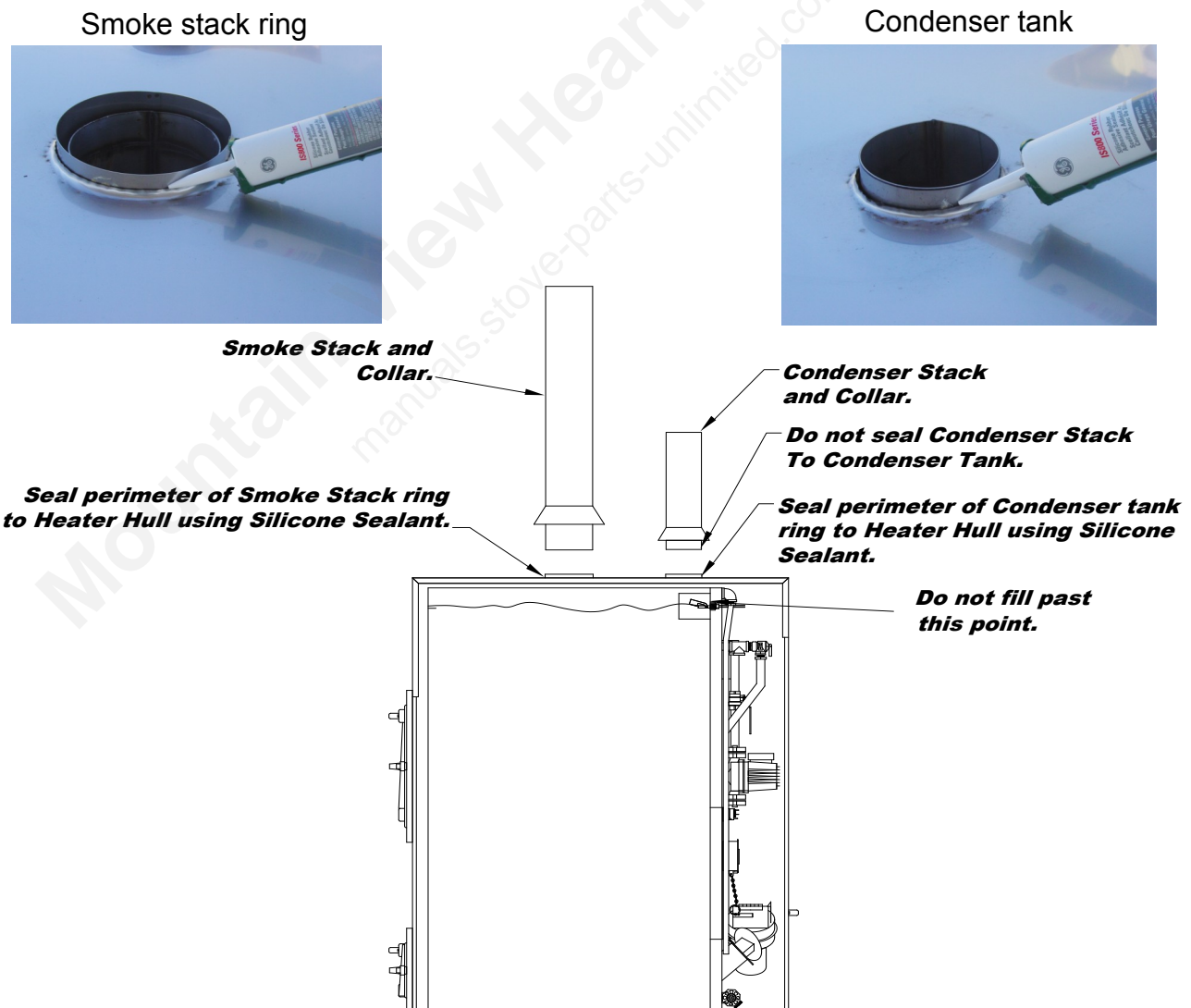

3-7 Filling the Heater with Water

The Heater must be filled with water before starting a fire.

There are certain parts of the country that have high enough levels of chloride in the water to be harmful to stainless steel tanks. Even though the USDA allows up to 250 parts per million of chloride (salt) in the water as acceptable for drinking, experience has shown that chloride levels as low as 45 parts per million will eventually cause stress corrosion cracking in stainless steel tanks when water is heated. It is therefore required to use rain water, bottled water, or your water supply with chloride content of less than 15 parts per million. Call your Hardy dealer to get a chloride test on your water supply.

Fill your heater with water through the condenser stack opening or when you supply power to the heater if the heater has the automatic fill option it will fill itself. If the chloride content of your local water supply exceeds the specifications mentioned above and necessitates the use of bottled or rain water, please do so to maintain the warranty of your heater.

There is a low water switch located in a fitting on the back of the heater. This low water switch operates a low water warning light and automatic water fill solenoid if your heater has the automatic fill option.

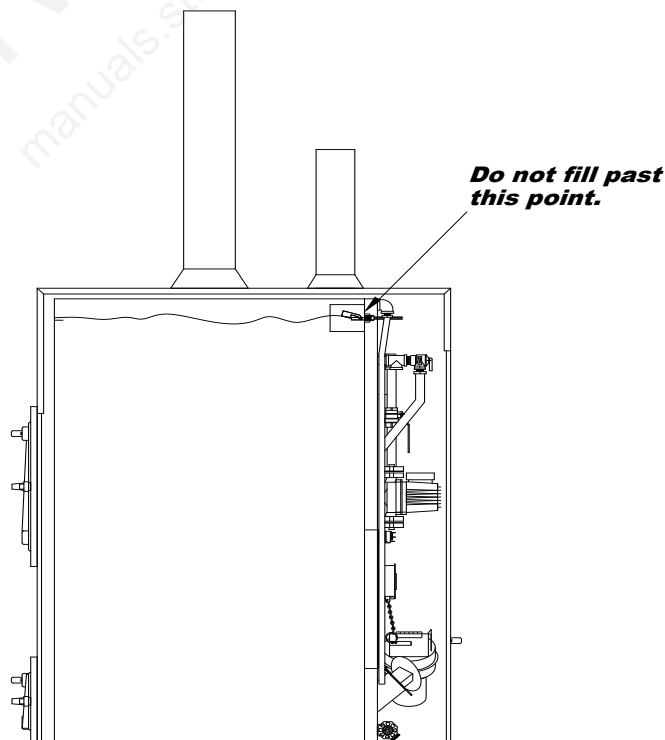

SECTION IV

CONNECTION TO CENTRAL HEATING/AC SYSTEM

4-1 Connection to Central Unit with Existing Blower Relay

This unit must be wired by a qualified electrician in accordance with the National Electrical Code.

Turn off all power going to your central air handler system.

You will need to add a double pole / double throw relay to your central air handler. You will also need a heat only thermostat added to the wall, preferably next to the existing thermostat. Run a two (2) conductor thermostat wire from the air handler to the new heat only thermostat that was added to the wall. The normal colors for this wire are red & white. You will also need a three (3) conductor thermostat wire running from the air handler to the outside wood heater. The normal colors for this wire are red, white, & green.

NOTE: If you are not familiar with the control circuit of your central unit, do not continue beyond this point. Call a heating and air conditioning serviceman to complete the wiring. Improper wiring can cause excessive electrical usage or cause your blower motor to over heat and burn out.

Remove the cover on the new home heat thermostat to mount it on the wall. There is a round dial visible with an adjustable pointer. This is the heat anticipator. The dial also has a series of numbers. The pointer must be set to the highest number on the dial. On the Honeywell model #(t 822-1016), the pointer is turned counter clockwise as far as it can go. On the thermostat connect the red wire to the screw terminal marked R and the white wire to the screw terminal marked W.

At the heater, connect the white wire to terminal 8 of the water pump relay (R-3). Connect the red wire to one side of the low temperature sensor (the round disc with two terminals under the insulation near the center of the heater approximate 12" from the top). This is an option that prevents the pumping of water less than 100°F but is not required. If you elect not to use this option, then only a two wire conductor is required, bypassing the low temperature sensor. Connect a jumper wire from the other side of the low temperature sensor to terminal 7 of the water pump relay (R-3) and also connect the green wire to terminal 7 of R-3. If only two wires are used then one is connected to terminal 7 and the other to terminal 8.

4-1 Connection to Central Unit with Existing Blower Relay (continued)

This unit must be wired by a qualified electrician in accordance with the National Electrical Code.

At the air handler inside, find the red wire going from the air handler control wiring to the original wall thermostat. Cut this wire and connect the end that is going to the wall thermostat to terminal # 2 on the new relay. The end of the red wire that is still connected to the control wiring of the air handler will need to be connected to terminal # 1 along with the new red wire that is going to the new heat only wall thermostat. Locate the Green wire going from the central air handler control wiring to the original wall thermostat. Cut this wire. Connect the end of the green wire that is going to the original wall thermostat to terminal #5 of the new relay. Connect the end of the green wire that is still connected to the central air handler control wiring to terminal #4. Connect the white wire going to the new heat only thermostat to the red wire going outside to the wood heater. Take the green wire that is going outside to the Hardy Hydronic Heater and along with a short jumper wire (appx. 3" - 4" long) connect to terminal #7 on the new relay that was added to the air handler. Connect the other end of this jumper wire to terminal #6 of the relay.

Locate the low voltage transformer that is providing you with 24 volt power. Find the common lead of this transformer and connect a wire to this lead and to terminal #8 of the new relay along with the white wire going outside to the Hardy Hydronic Heater .

If all connections are made properly and the water in the Hardy Hydronic Heater is hot, the unit should be ready for operation.

NOTE: This is a general diagram. You may have to make various changes according to how your unit is wired. Insure that the compressor on a heat pump or A/C unit does not run when the wood system is running. Insure that the gas burner, oil burner, or electric elements do not come on when the wood system is running. Insure that only one speed of the blower motor can be energized at one time. If more than one speed is energized at the same time, the blower motor will burn out. Insure that the volt amp rating of the existing 24 volt transformer is not exceeded when the relays in the Hardy Hydronic Heater system are energized.

4-2 Connection to Central Unit with existing Blower Relay Diagram

CONNECTION DIAGRAM

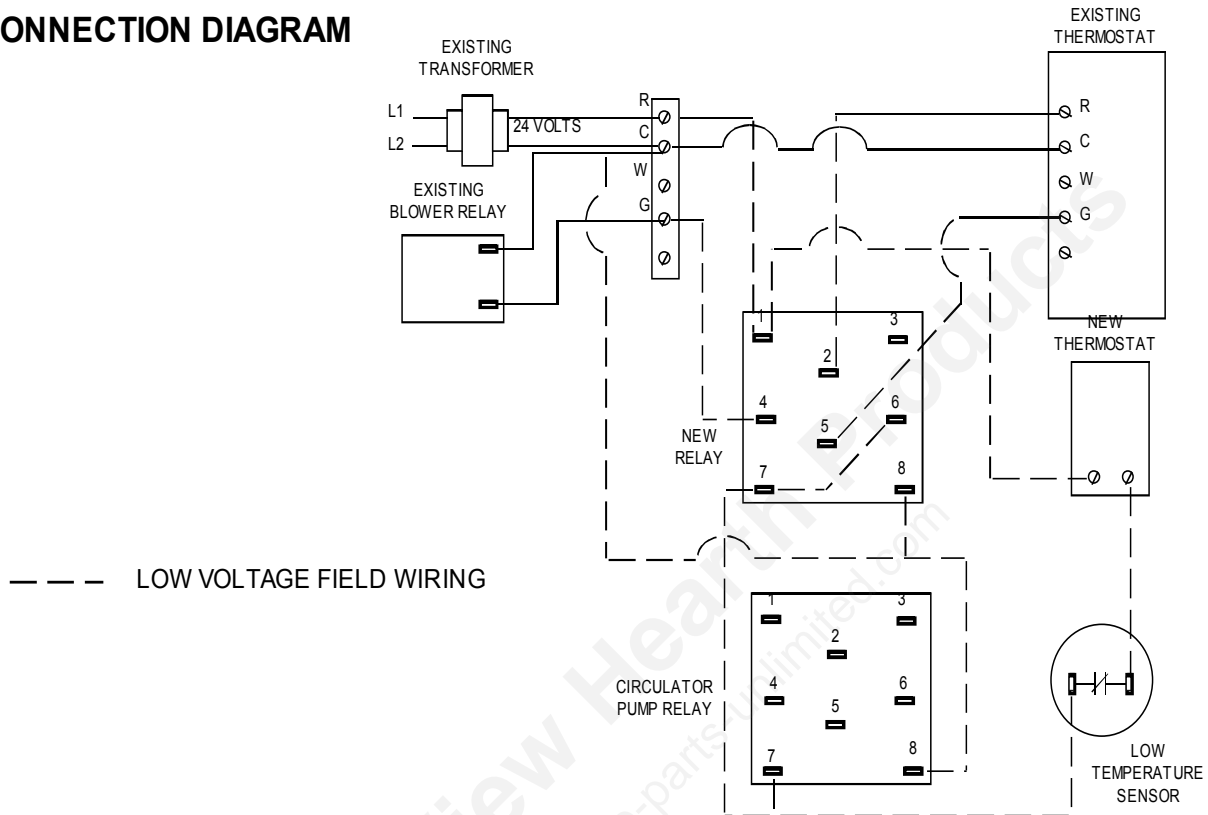

SCHEMATIC DIAGRAM

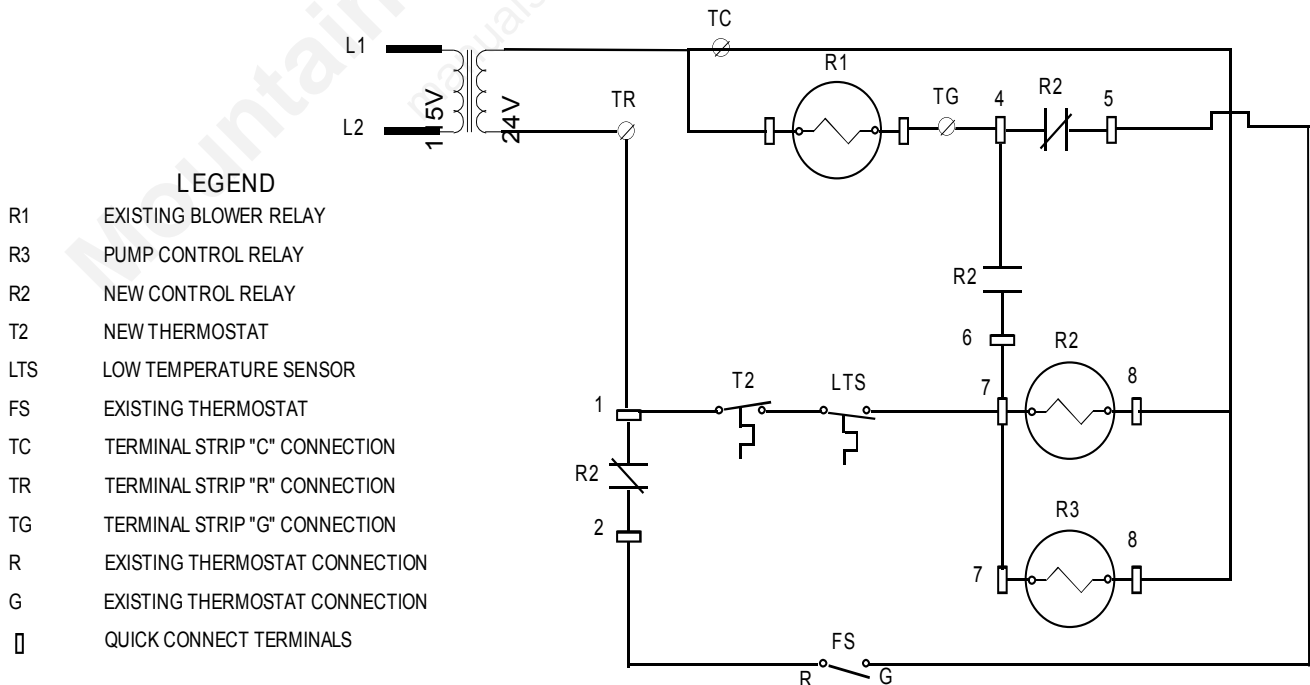

SECTION V

HEATER OPERATION

5-1 Firing the Heater

Hardy Manufacturing Company Inc.'s recommended fuel for the Hardy Hydronic Heater is seasoned dry hard wood. Green wood or wet wood is not recommended for use in the Hardy Outside Wood-Fired Hydronic Heater.

Never burn the following: trash, plastics, gasoline, rubber, naphtha, household garbage, material treated with petroleum products (particle board, railroad ties, and pressure treated wood), leaves, paper products, and cardboard. Never use starters: Lighter fluids, gasoline, or chemicals.

Once the Hardy Hydronic Heater has been filled with water, you can build a fire. Plug the two (2) wire power cord into the GFCI receptacle in the back of the heater, this should open the draft damper and turn on the draft blower. You build a fire in the Hardy Hydronic Heater the same way you would in any other wood heater. Start out with small split dry wood. Once you have the small wood lit gradually add more split wood and gradually increase the size of the wood. Once a bed of coals has been established you can use larger wood.

5-2 Water Temperature

Mounted on the back of the heater is an aqua stat that controls the draft system of the heater to maintain a preset temperature. When the fire has heated the water in the tank to the set aqua stat temperature, normally around 170 to 175 degrees Fahrenheit, the draft damper and blower will shut down. This allows the fire to smother down to a smoldering stage. As heat is used and the water temperature drops below the set temperature the draft damper and draft blower will reenergize to build the fire back to a heating stage.

Never set this aqua stat below 140 degrees, (this would allow the heater to sweat) or above 180 degrees (this would bring the heater to close to a overheating point).

5-3 Moisture in the Firebox

During startup of a new heater or the first time you operate an existing heater each year, you will probably notice moisture in the firebox. This is normal and should not cause alarm. If after a few days of operation a high moisture content is still evident the heater should be shut down and checked for leaks.

5-4 Wood Usage

Any fuels other than those specified will result in poor and erratic heater performance. This heater is designed to use a minimum amount of fuel but as with any heater of this type fuel usage is based upon the load and temperature requirements. Refer to the troubleshooting section located in the appendix for problems associated with excessive fuel usage or poor heater performance.

5-5 Improper Burning

Improper burning during the normal operation of the heater is usually caused by lack of combustion air or fuel in the firebox chamber. Check the air passage into the firebox from the draft blower to make sure there is no blockage, such as ashes built up in front of the air passage or creosote blocking the opening. Check the damper lid to make sure it is opening properly. Check to see if the draft blower is running. Also unplug the power cord and allow the draft blower to stop, then check the blower wheel for any buildup that could reduce the efficiency of the draft blower. Check to see if the grates are stopped up. Use a poker to stir the coals and create air holes in the coal bed. Check the smoke stack for creosote build up. Also on the H4 & H5 models there is a removable baffle plate directly below the smoke stack inside the firebox that will need to be removed and cleaned.

5-6 Ash Removal

Ashes must be removed from inside the heater on a routine basis. Excessive ash buildup inside the Ash box will reduce heating efficiency and can lead to premature breakdown or warp age of the grates. When you remove the ashes, leave approximately 1" of ash in the ash bin, this will give the coals that fall through the grates a bed to fall on, and prevent the coals from warping the ash pan itself. The build up of ashes in the firebox should be checked at least once a week. Allow the fire to burn down until the grates can be seen. This insures that the grates are clear. If the grates do warp slightly they can be flipped and allowed to straighten back out.

5-7 Ash Disposal

Ashes should be placed in a metal container with a tight-fitting lid. The closed container of ashes should be placed on a noncombustible floor or on the ground, well away from all combustible materials, pending final disposal. If the ashes are disposed of by burial in soil or otherwise locally dispersed, they should be retained in the closed container until all cinders have thoroughly cooled.

5-8 Creosote Formation and Removal

When green wood is used or when wood is burned slowly, it produces tar and other organic vapors, which combine with expelled moisture to form creosote. The creosote vapors condense in the relatively cool chimney flue of a slow burning fire. As a result, creosote residue accumulates on the flue lining. When ignited this creosote makes an extremely hot fire.

The chimney connector and chimney should be inspected at least twice monthly during the heating season to determine if a creosote buildup has occurred. If creosote has accumulated it should be removed to reduce the risk of a chimney fire.

Mountain View Hearth Products
manuals.stove-parts-unlimited.com

SECTION VI

SERVICE INFORMATION

WARNING:

**When working with electrical circuits, use caution to avoid electrical shock
Service on this heater should only be performed
by a qualified service technician.**

6-1 Electric Make-Up Water System

LOW WATER SWITCH, P/N H1100.28

The low water switch is a horizontally mounted reed switch that has a magnet in the floating portion of the switch. When the water level is high enough to raise the magnet up off of the reed switch this allows the switch to break contact, and discontinue power to the water solenoid. When the water level drops the floating portion of the low water switch the magnet will once again come into close proximity of the reed switch and close the contacts allowing power to be applied to the water solenoid. If this switch is working in an opposite order to this it will need to be tightened another 180 degrees to allow the switch to operate correctly. Never add any additional load to this switch since it is only rated for 30 watts.

LOW WATER LIGHT, P/N H1100.30

115 VAC indicator light controlled by the float switch. The light comes on when the water level in the heater is low.

ELECTRIC WATER SOLENOID, P/N H1100.00

115 VAC electric solenoid controlled by the float switch. This solenoid keeps the heater full of water by allowing water to fill the heater when the float switch closes.

WATER FILTER, P/N H1100.55

A 100 mesh filter washer is located in the 1/2" x 1/4" brass hex bushing at the solenoid. It is inserted with the cone of the screen pointed out. Filter washers are always placed where the cone points toward the water flow. It can be removed for cleaning.

6-2 Water Circulation System

LOW TEMPERATURE SENSOR, P/N H2000.36

This sensor can be wired in the home heat thermostat circuit to prevent the pump from running when the water in the Hardy Hydronic Heater is not hot. The sensor has a set of contacts that close when the water rises to 110°F and open when the water drops to 90°F.

WATER PUMP RELAY, P/N H2000.52

This is a Honeywell DPDT relay with a 24 volt coil. Terminal 4 and 6 (normally open contacts) are used to turn on the water pump. Control voltage (24 volts) connected at terminals 7 and 8 routed through a home thermostat energizes the relay.

WATER PUMP FOR HEATING SYSTEM, Taco 009 pump P/N H502.50

with stainless steel body. If the pump will not run, first unplug the power cord then check the water pump relay. The relay can be bypassed by moving the wire on terminal 6 to terminal 5 (terminals 4 to 5 is normally closed) and disconnecting the thermostat wire from terminal 8. Now plug the power cord back in. This should supply 115 vac directly to the pump. If the pump will still not run, unplug the power cord. Remove the four bolts holding the pump to the pump housing. Remove the cartridge from the pump. Spin the impeller if it will not spin, replace the cartridge. If the impeller will spin, it may have been temporarily stuck (reassemble and try again) or the problem is the electrical winding or capacitor. Use an ohm meter to check the winding and capacitor. If the capacitor is defective, replace it. If the electrical winding is defective, replace the complete pump.

6-3 Temperature Control System

DAMPER AQUA STAT, P/N H2000.08

This thermostat has a probe that is inserted in a well fitting in the water tank of the Hardy Hydronic Heater . It has one set of contacts that open on a temperature rise and close on a temperature fall. This thermostat is normally set between 170°F to 175°F. It controls the damper solenoid and the forced air draft. If the damper solenoid and forced air draft will not operate, place a jumper wire across the thermostat terminals. If they operate when the thermostat is jumpered out, and the temperature of the water in the heater is below the set point on the thermostat, the thermostat is defective. Do not leave the jumper on the thermostat because the heater will overheat.

DAMPER SOLENOID, P/N H 2001.05

This solenoid lifts the cover off the intake to the forced air draft blower. The solenoid is controlled by the damper thermostat. It should lift the cover when the forced air blower comes on and drop the cover after the blower goes off. If the solenoid does not drop the cover when the blower goes off, the solenoid should be replaced. The forced air draft intake cover must be in place when the blower is not running or the heater will overheat and cause excessive wood usage.

FORCED AIR DRAFT BLOWER, P/N H2002.16(28)

The Hardy Hydronic Heater must be installed outdoors to maintain proper air for combustion. The draft blower will draw fresh air from under the outer hull and from around the cracks of the door jamb and back door. If the blower wheel or the intake to the blower is clogged, the blower will not deliver the proper amount of air to the fire. The blower can be disassembled and cleaned. Be sure to seal the blower motor back to the blower housing if the blower is disassembled. The motor should be oiled at the beginning of each heating season. When the heater is not in use, the power cord for the blower should be unplugged.

SECTION VII

HEATER MAINTENANCE

7-1 Preventative Maintenance

Preventative maintenance can provide improvements in system performance as well as a marked reduction in comfort complaints. The customer should perform preventative maintenance actions to avoid unnecessary shutdown time and save repair expenses.

Preventative Maintenance Checklist:

Ground Fault Interrupter Receptacle > Test monthly to insure proper and safe operation. (a) Check with a circuit tester to determine if the polarity is correct. (b) Press the test button, the reset button should pop out indicating the interrupter has tripped. Press the reset button to restore to normal operation.

Heater Piping > Check all piping occasionally on back of heater for any possible water leaks. Water leaks on heater components can cause electrical shorts, damage to component parts and insulation.

Low Water Light > Check the low water warning light each week for proper operation to avoid low water or over filling in heater with electric make-up water systems. See service information (section VI) in owners manual for approved procedures.

Ash Bin > Keep ash bin from ash buildup. Remove ashes before they build up to the level of the grates. This will restrict proper air flow and cause the grates to warp. Leave at least 1/2" to 1" of ashes in bottom of ash pan to protect the bottom from burnout.

Damper/Draft System and Smoke Stack > Check at least every two weeks for build up of ash, tar, or any other material that could restrict the amount of air flow required. Oil the blower motor bearings prior to each heating season with 10 to 20 drops of electric motor oil.

Door Seals > Check firebox door and ash door seals occasionally for damage or obstructions that would affect an airtight seal.

7-2 Preseason Maintenance

The Hardy Hydronic Heater is designed for ease of operation and service. There is maintenance that has to be done for proper operation of your new unit. Each year, before the heating season begins, you should check your heater to insure that everything is ready for the heating season.

ELECTRIC MAKE-UP WATER – Turn on the cold water supply to the heater. Plug in the power cord. Check the float switch operation by lifting up and pushing down on the float. When you push the float down it should activate the electric water solenoid and allow water to enter the heater water tank. When you lift up on the float it should deactivate the water solenoid, stopping the water. Also make sure the float will float up on its own when the water level is high enough. After checking the float and solenoid operation, you should be able to determine if either of these components will require replacement. Next, turn off the cold water supply and remove the screen filter. This filter is located in the 1/2" x 1/4" brass bushing between the 1/2" brass ball valve and the electric solenoid valve. Clean this filter or replace it. Reinstall the screen filter, making sure the cone point of the screen is pointing towards the incoming water. Turn the cold water supply back on.

WATER QUALITY – The Hardy Hydronic Heater is designed not to lose heater water through evaporation. At times during the year, accidental overheating can occur, and the water will evaporate. The evaporation causes a concentration of chlorides (salts) and other minerals. To protect your heater from this build up of chlorides (salts) and other minerals, we recommend to drain your heater each year at time of startup for the heating season and refill with rain water or bottled water with a chloride concentration of less than 15 parts per million. This will add to the life of your stainless steel tank.

DAMPER AND DRAFT SYSTEM – When you plugged in the power cord, the damper solenoid should have opened the draft lid on the draft blower. The forced air draft blower should also have come on. If both of these components are working correctly, unplug the power cord. Open the clean out lid beside the draft blower and check for any build up of ash, tar, or any other material that could restrict the amount of combustion air entering the heater. Check the seal on the clean out lid to assure a good air tight seal is still established. Lift the damper lid on the draft blower and inspect the blower wheel for any build up of lint, dust, creosote, or any other substance that could affect the performance of the draft blower. Spray the damper lid hinge, and the damper solenoid plunger with WD-40, or its equivalent. Oil the draft blower motor with electric motor oil, or 10 weight no detergent motor oil. Do not use WD-40, or machine oil. Check the grates inside the heater to see if there is any ash build up or if the grates are warped. If a grate does warp, lift that grate up and turn it over. Also at this time check the smoke stack for blockage, and the flame/baffle in the H4 & H5 models.

7-2 Preseason Maintenance (continued)

WATER PUMP – Unplug the power cord going to the water pump. Close the valve above the water pump and the return water valve at the bottom of the heater. Remove the pump motor from the pump housing by removing the four bolts in the pump housing. Remove the impeller cartridge assembly from the pump housing. Check the impeller to determine that it is free by spinning the impeller in the cartridge. Check the pump housing for rust or any other build up that could impede the flow of water. Reassemble the water pump, making sure the “O” ring in the cartridge is seated right. Once the pump is reinstalled, open the water valve above the pump and the return valve.

GASKETS - Check all door seals. To replace a door seal remove the door and frame from the heater. Pull out old seal and clean the door and frame of all old silicone. Put two small beads of silicone in the gasket area of the door and install rope into this area starting at one corner. New rope seals are 5/8” diameter and 64” length for the fire box door, and 48” length for the ash door. Work the rope down smooth all the way around the door and cut off excess rope. Fill in the corner gaps with silicone, allow to dry before seating against the frame. To reinstall the door, clean the frame of the heater of all old silicone. Put a generous bead of silicone on the heater door frame being sure to fill the corner joints with the silicone. Reinstall the door into the same screw holes.

Tighten all screws, wipe off any silicone that might have squeezed out.

Check the gasket on the clean out lid on the air tube in back of the heater. To replace the gasket on the clean out lid first remove old gasket completely. Put a generous bead of silicone on the back side of the lid where it will be coming into contact with the square air tube going into the heater. Place a piece of wax paper across the silicone to prevent it from sticking to anything other than the lid. Spray the wax paper with a misting of water to allow the paper to become more flexible. Close the lid down gently onto the air tube, lift back up to check for a indent into the paper and silicone seal. If indent has wrinkles in the paper gently lift the paper away from the silicone to straighten back out and set lid back down to form the seal again. You may have to do this step a couple of times until you get a good seal. Once the seal has been formed, let the lid rest on the air tube until silicone seal has cured.

7-3 In Season Maintenance

WATER LEVEL- Monitor water level in the heater by removing the condenser stack and looking inside the water tank. You should be able to see the low water switch inside the splash guard in the water tank. The low water switch is a horizontally mounted reed switch that has a magnet in the floating portion of the switch. When the water level is high enough to raise the magnet up off of the reed switch this allows the switch to break contact, and discontinues power to the water solenoid and low water light. When the water level drops the floating portion of the low water switch the magnet will once again come into close proximity of the reed switch and close the contacts allowing power to be applied to the water solenoid and low water light. On models that do not have automatic fill the low water switch turns on power to the low water light only. The heater water level will need to be corrected manually by adding water to the condenser tank area until the low water light goes out. It is recommended that you check this water level at least once a week while the heater is in operation.

7-3 In Season Maintenance

ASH REMOVAL- Ashes must be removed from inside the heater on a routine basis. Excessive ash buildup inside the ash box will reduce heating efficiency and can lead to premature breakdown or warp age of the grates. When you remove the ashes, leave approximately 1" of ash in the ash bin, this will give the coals that fall through the grates a bed to fall on and prevent the coals from warping the ash pan itself. The build up of ashes in the firebox should be checked at least once a week. Allow the fire to burn down until the grates can be seen. This insures that the grates are clear. If the grates do warp slightly they can be flipped and allowed to straighten back out.

AIR PASSAGE- After you remove the ashes from the heater you need to check the total air passage (from blower to stack). Unplug the two wire power cord so the blower will not accidentally come on while you are checking it. Raise the damper lid up on the blower to check the blower wheel for any build up or obstructions. Raise the cleanout lid on the main air tube going into the back of the heater. Check the clean out for blockage, such as creosote build up or ashes. Check the grates for build up on top of grates that could block the flow of air to the fire. Check the smoke stack for creosote build up. In the H4 and H5 models there is a baffle plate mounted in the fire box directly below the smoke stack. This baffle plate can be removed for cleaning. This baffle plate is laying across two (2) pipes in the top of the fire box and can be slid to either side for removal. Any obstruction of the exhaust gases or the supply air to the fire will make the heater not perform correctly. When finished checking and/or cleaning plug in the power cord to put heater back in service.

7-4 Post Season Maintenance

Preplan when you want to shut your system down. Allow your heater to burn completely out of fuel and cool down. Turn off power to the heater. Unplug all power cords in the back of the heater. Clean out all ashes from the ash bin area and any build up of ashes and creosote from the firebox area. Remove the grates and support beams to facilitate in this cleaning. Once the heater has been cleaned out, replace the support beams and grates back into the heater. On the H4 and H5 models remove and clean the baffle plate in the top of the fire box, and clean out the smoke stack.

Section VIII APPENDIX

8-1 GENERAL TROUBLE SHOOTING GUIDE

WARNING:

**When working with electrical circuits, use caution to avoid electrical shock
Service on this heater should only be performed
by a qualified service technician.**

Complaint	Area of Trouble	Possible Cause	Corrective Action
Ground Fault Interrupter Receptacle Tripping	Ground Fault Interrupter Receptacle	1. Moisture in receptacle 2. Receptacle not grounded properly.	1. Remove cover and check for moisture inside box. If moisture is present, use blow dryer to dissipate. 2. Remove cover and check the bare copper wire connected to the green screw for secure attachment. Test receptacle for proper operation.
	Forced air draft blower and damper solenoid.	Moisture or corrosion in electrical connections or windings	Check electrical connections and windings for moisture or corrosion. Clean or dry and then test for proper operation.
	Pump motor	Corrosion in motor electrical connections or windings	Check electrical connections, capacitor and motor winding for bad connections or corrosion. Clean, dry and then test for proper operation.
	Liquid level switch, low water light, and water solenoid valve	Bad connections possibly to ground	Check electrical connections for bad connections or corrosion. Clean, dry and then retest for proper operation.

8-1 GENERAL TROUBLE SHOOTING GUIDE

Complaint	Area of Trouble	Possible Causes	Corrective Action
No Heat	Pump performance	Unplug pump and bypass relay by tying relay wires #4 and #6 together. Plug pump back in.	
Main power supply and ground fault interrupter receptacle "OK"	Pump does not run	1. Defective pump cartridge	1. Unplug pump. Remove pump. Pull cartridge from pump and spin impeller by hand. If impeller will not spin, replace cartridge. 2. Use ohm meter. When the meter is connected to the capacitor, the needle should jump towards "0" ohms and slowly drift back to infinity. Replace if defective.
Water temperature is "HOT"		2. Defective pump capacitor	
		3. Defective pump motor winding	3. Disconnect the wires connected to the motor terminals to test the motor independent of electrical connections. Check for ground and continuity with ohm meter. The insulator of the windings should show no breakage. If it does, replace pump

8-1 GENERAL TROUBLE SHOOTING GUIDE (continued)

Complaint	Area of Trouble	Possible Cause	Corrective Action
No Heat	Pump Performance	Unplug pump and bypass relay by tying relay wires #4 and #6 together. Plug pump back in.	
<p>Main power supply and ground fault interrupter receptacle "OK"</p> <p>Water temperature is "HOT"</p>	Pump does run	<ol style="list-style-type: none"> 1. Defective 24 volt transformer 2. Defective wall thermostat (heater) 3. Defective low temperature sensor 4. Defective pump relay 	<ol style="list-style-type: none"> 1. Located at existing central unit. If 120/230 volts is being supplied to primary side check for 24 volts on secondary. If 24 volts not present, replace transformer. 2. Located inside home. Remove cover. Check for 24 volts. Level the mounting base. Blow dust from sensing bimetal. Adjust heat anticipator. See owners manual connection instructions. 3. If heater is up to temperature (over 140° f.), remove wires on sensor and connect to each other to bypass. If pump runs replace low temperature sensor. 4. Check relay terminals #7 & #8 for 24 volts. If 24 volts is present, use ohm meter to check contacts. Connect ohm meter to terminals #4 & #6. If no reading replace relay.

8-1 GENERAL TROUBLE SHOOTING GUIDE (continued)

Complaint	Area of Trouble	Possible Cause	Corrective Action
<p>No Heat</p> <p>Main power supply and ground fault interrupter receptacle "OK"</p> <p>Water temperature is "COLD"</p>	Aqua stat	Defective Aqua stat	Unplug power cord. Connect the two wires on the aqua stat together. Plug in power cord. If blower and damper solenoid operates, replace aqua stat.
	Damper solenoid	Defective damper solenoid	When bypassing aqua stat, if solenoid does not lift the lid off the intake to the forced air draft blower, replace the solenoid.
	Forced air draft blower motor	Defective blower motor 1. Defective electrical wiring 2. Air passage stoppage 3. Blower wheel clogged	1. Make sure all connections are secure. 2. Clear air passages in cleanout and damper blower outlets. 3. Clear blower wheel of any lint, ashes or creosote buildup.
	Ash bin	Ash buildup in ash bin	Clean out ash bin. Ash bin should be cleaned out each week. Ash buildup on grates can cause grates to warp. If grates warp they can be turned over and allowed to straighten. When removing ashes, leave at least 1" of ashes in bottom of ash pan.
	Heater stack	Ash and creosote buildup	Clean heater stack of any ash and creosote buildup. On H4 models make sure the baffle plate is clear of ash and creosote buildup. Make sure baffle is in place, otherwise heat will be lost up the stack.

8-1 GENERAL TROUBLE SHOOTING GUIDE (continued)

Complaint	Area of Trouble	Possible Cause	Corrective Action
<p>No Heat</p> <p>Water Level is "LOW"</p> <p>Water temperature is "HOT"</p> <p>Main power supply and Ground Fault Interrupter Receptacle "OK"</p>	<p>Water supply</p>	<p>Defective Liquid Level Switch.</p>	<p>Liquid level switch controls the water level indicator light and water solenoid valve. Check switch with hand by raising or lowering float inside the condenser area. If water solenoid does not click and light does not go on and off, replace the liquid level switch.</p>
	<p>Water solenoid valve</p>	<ol style="list-style-type: none"> 1. Defective solenoid valve 2. Water filter 	<ol style="list-style-type: none"> 1. If water solenoid valve does not click when checking the liquid level switch, but level indicator light does come on – replace solenoid valve. 2. Remove filter screen from 1/2" bushing in end of 1/2" ball valve, clean or replace.

8-1 GENERAL TROUBLE SHOOTING GUIDE (continued)

Complaint	Area of Trouble	Possible Cause	Corrective Action
<p>No Heat</p> <p>Blowing cold air in house</p> <p>Water temperature is "HOT"</p> <p>Power "OK"</p>	<p>Water not circulating through the heat loop</p>	<ol style="list-style-type: none"> 1. Pump not operating 2. Inline valves closed/bad 3. Air trapped in plumbing 4. Scale deposits in hot water coil reducing water flow and restricting heat transfer 5. Air lock in hot water coil 	<ol style="list-style-type: none"> 1. See area of trouble: "Pump Operation" 2. Open or replace valves 3. Bleed lines if air is trapped (non pressured lines require pump to be running). 4. Disconnect the inlet and outlet of the hot water coil and clean with a scale remover solution. 5. Bleed air from hot water coil
<p>Excessive wood usage</p> <p>or</p> <p>Overheating (boiling)</p>	<p>Heater water boils</p> <p>(Symptom – pop off valve is relieving)</p>	<ol style="list-style-type: none"> 1. Doors open 2. Defective door seals 3. Damper blower lid stuck open 4. Damper aqua stat defective 5. Water lines / connections leaking 	<ol style="list-style-type: none"> 1. Close all doors and make sure they are securely fastened. 2. If the seal is bad it will need replacing. Call your local Hardy Dealer for parts. See Owners Manual for replacing door seals. 3. Unplug blower motor. Check lid and blower for creosote buildup. Remove blower, disassemble, clean, and oil. 4. Check temperature setting on aqua stat. Should be 170°F. If aqua stat is allowing blower to run until water boils, replace aqua stat. 5. Repair or replace all lines or connections that are leaking.



8-1 GENERAL TROUBLE SHOOTING GUIDE (continued)

COMPLAINT	AREA OF TROUBLE	POSSIBLE CAUSE	CORRECTIVE ACTION
<p>Excessive wood usage</p> <p>Or</p> <p>Overheating (boiling)</p>	<p>Excessive wood usage</p> <p>(Symptom; pop off valve is relieving heater water overflowing)</p>	<ol style="list-style-type: none"> 1. Pop off valve 2. Defective liquid level switch 3. Solenoid valve stuck or corroded 4. Domestic hot water heat exchanger coil leaking 	<ol style="list-style-type: none"> 1. If Pop off valve is relieving for no reason, replace pop off valve. 2. Check liquid level switch float for position, float should float up as the heater fills with water. Check switch by pivoting float up and down to see if solenoid clicks and light goes on and off, if not replace switch. 3. If solenoid does click and the heater still overflows, it could be stuck in open position, - remove and clean or replace. 4. Disconnect line to the electric water solenoid and turn off valve to system fill to assure no water enters tank from the fill system. If heater tank still overfills then remove heater hull and lid to check domestic water coil for leaks, repair or replace.

8-1 GENERAL TROUBLE SHOOTING GUIDE (continued)

COMPLAINT	AREA OF TROUBLE	POSSIBLE CAUSE	CORRECTIVE ACTION
Improper Burning	Grates	Grates stopped up	Clear grate of ash buildup. If grates are warped, turn over.
	Air intake	Damper blower clogged	Clean damper blower assembly.
	Air tube inspection lid	Air tube clogged	Lift inspection lid and cleanout all obstructions.
	Smoke Stack	Smoke stack stopped up	Remove smoke stack, check flue out of top of heater, clean both flue pipe and smoke stack.
	Baffle	(Model H4 & H5 Only) Baffle stopped up	Remove baffle through the fire box door, clean baffle and flue area.
	Fire	Fire going out	If fire goes completely out remove one screw in blower lid.
	Forced air blower running but no draft	1. Solenoid not lifting lid 2. Creosote buildup	1. Replace solenoid. 2. See excessive wood usage.
Moisture In fire box	Fire box	1. Initial or yearly start up 2. Green wood	1. Fire box walls will sweat and water will run down sides, this should clear up in about a week. 2. Green wood will create moisture at any time.

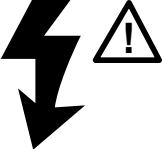

8-2 Circulator Maintenance Instructions

Step #	Operation Description	Visual Aids/Comments
 DANGER Hazardous Voltage! Disconnect Power to Heater prior to performing this maintenance operation.		
Testing/Replacing Pump Cartridge		
1	Close the pump inlet and return ball valves to prevent water flow.	
2	Loosen and remove the four(4) 7/16" screws from the pump motor housing.	
3	Gently pull the pump motor housing toward you and turn so you can view pump impellar.	
4	Rotate the pump impellar by hand. If the impellar will not spin freely then replace the cartridge.	
5	Reassemble in reverse order.	

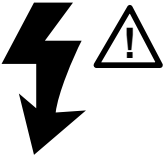

8-2 Circulator Maintenance Instructions (continued)

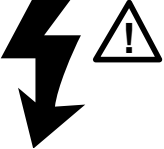
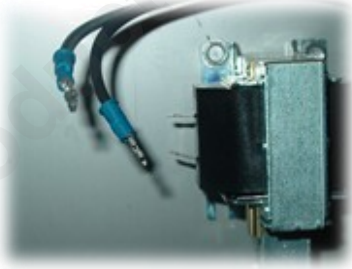
Step #	Operation Description	Visual Aids/Comments
	DANGER	Hazardous Voltage! Disconnect Power to Heater prior to performing this maintenance operation.
Testing Pump Capacitor		
1	Remove top cover to expose electrical connections.	
2	If using an analog ohm meter, check the resistance across the two capacitor leads. The meter should immediately read "0" ohms then slowly drift to infinity. Reverse the test leads and check meter reading. The test procedure is the same for a digital multimeter except the meter will show some resistance then return to "OL" (open line). To replace capacitor, cut away existing wire nut connectors. Strip leads and connect with wire nut connector suitable for two(2) 16 AWG wires.	
3	Replace cover.	
Testing Pump Motor Winding		
1	Disconnect power cord from motor wiring. Using an ohm meter or continuity tester, check the continuity across each power wire and also check each power wire to ground. If the the pump does not show continuity across the two power wires or if either power wire shows continuity to ground the winding is defective and the pump should be replaced.	

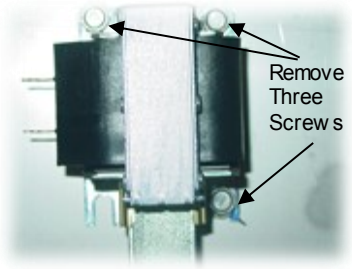
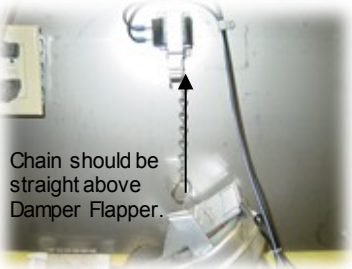

8-3 Damper Solenoid Replacement Instructions

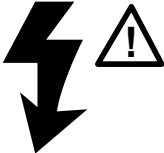
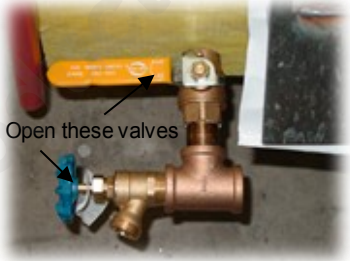
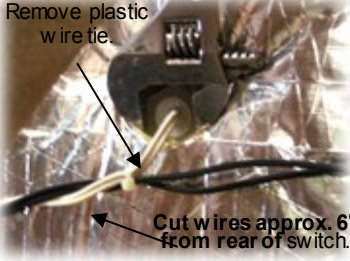
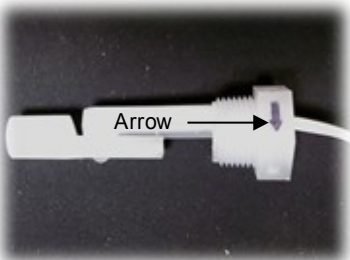
Step #	Operation Description	Visual Aids/Comments
 <p>DANGER Hazardous Voltage! Disconnect Power to Heater prior to performing this maintenance operation.</p>		
1	Remove female quick connect terminals from damper solenoid.	
2	Using needle nose pliers, open top link in lift chain and remove from solenoid.	
3	Using a 5/16" wrench or other suitable tool, remove the three screws holding the Damper Solenoid to the electrical panel.	
4	Install new damper solenoid in reverse order. Make sure chain is straight above the flapper lifter as shown. There should be tension in the chain when the flapper is in the down position.	





8-4 Low Water Switch Replacement Instructions

Step #	Operation Description	Visual Aids/Comments
 DANGER	Hazardous Voltage! Disconnect Power to Heater prior to performing this maintenance operation.	
1	Open the tank drain valves until the water level is below the float switch.	
2	Remove plastic wire tie located near float switch. Cut the switch wires approx. 6 inches from the rear of the float switch. On models with the automatic water fill option do not cut the power wires for the solenoid. Using an adjustable wrench or other suitable tool remove the float switch from the heater.	
3	Looking at the wrench flats on the switch there are two directional arrows located on the side as shown. For the switch to operate correctly it will have to be oriented with the arrow pointed down when installed.	
4	Apply pipe joint compound liberally around the threads of the switch. Using an adjustable wrench or other suitable tool install the switch in the tank. Do not overtighten. Make sure the switch is oriented with the arrow pointing down.	



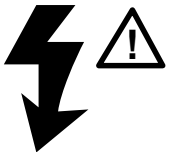
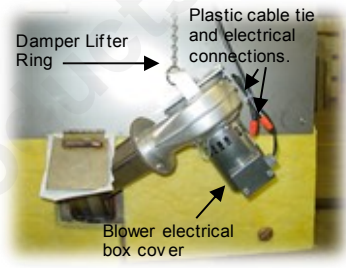

8-4 Low Water Switch Replacement Instructions (continued)

Step #	Operation Description	Visual Aids/Comments
	 DANGER	Hazardous Voltage! Disconnect Power to Heater prior to performing this maintenance operation.
5	Connect new switch wiring to existing wiring using suitable wire nut.	
6	Reconnect power to furnace. On models with the automatic water fill option allow the unit to fill above the float switch. If the automatic water fill and low water indicator mounted on side of hull does not turn off when the water reaches the correct level, the switch is possibly not oriented correctly. On units without the automatic water fill option, fill the tank until the water level is above the float switch. The low water light mounted on the left side of the hull should turn off when the water is at this level. If the light does not go out the switch is possibly oriented incorrectly.	



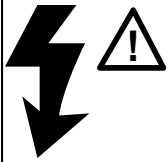



8-5 Draft Blower Replacement Instructions

Step	Operation Description	Visual Aids/Comments
 DANGER	Hazardous Voltage! Disconnect Power to Heater prior to performing this maintenance operation.	
1	Remove the plastic cable tie and disconnect the blower power wires as shown. Remove damper lifter ring from blower flapper lifter. Using a 5/16" wrench or other suitable tool, remove the blower electrical box cover.	
2	Slide a flat head screwdriver into plastic romex connector and lift up wedge clamp. Pull blower power wires through clamp. Remove clamp by pressing on locking tang with a flat head screwdriver and pulling away from blower.	
3	Loosen and remove the three flange screws. Remove blower from heater.	
4	Place new flange gasket onto blower flange. Align holes on gasket with holes in flange. Start inner screw but do not tighten.	
5	Position blower over gasket. Tighten inner screw to hold blower in position, then install and tighten the two outer screws.	

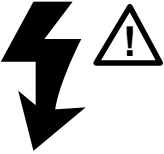



8-5 Draft Blower Replacement Instructions (continued)

Step	Operation Description	Visual Aids/Comments
 DANGER	Hazardous Voltage! Disconnect Power to Heater prior to performing this maintenance operation.	
6	Install damper lifting ring into the damper lid as shown.	
7	Using a 5/16" wrench or other suitable tool, remove the cover from the blower electrical box and set aside. Using pliers or other suitable tool, remove the right knockout and install the plastic romex connector.	
8	Push blower power wires through connector. Replace blower electrical box cover. Using pliers press the wedge clamp into place.	
9	Connect power wires and install plastic cable tie if available.	
10	Verify blower is firmly attached to flange and damper flapper will lift freely.	
11	Reconnect power to furnace.	



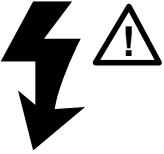
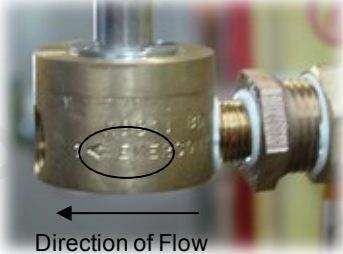

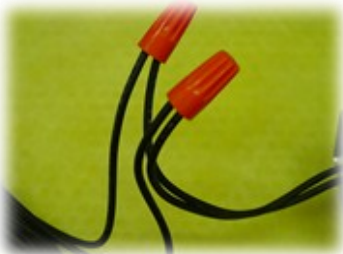

8-6 Automatic Water Fill Replacement Instructions

Step #	Operation Description	Visual Aids/Comments
 DANGER	Hazardous Voltage! Disconnect Power to Heater prior to performing this maintenance operation.	
1	If you are replacing the water fill solenoid then cut wires to automatic water fill approx. 4" to 6" from rear of fill solenoid as shown. Cut only if solenoid is to be replaced.	
2	Firmly pull solenoid up and away from switch post as shown. If you are replacing the solenoid then discard. Otherwise set the solenoid aside for later installation. If you are not replacing the water fill valve then skip to step # 8.	
3	Using an adjustable wrench loosen and remove the flex line fitting from solenoid assembly and set aside.	
4	Using an adjustable wrench or other suitable tool remove the automatic water fill assembly from heater. Remove the brass elbow, 1/2"x1/4" bushing and 1/4" close nipple from the assembly. These parts will be reused on the new assembly.	
5	Clean the screen inside the 1/2"x1/4" brass bushing prior to re-installation using warm soapy water.	

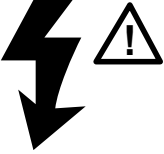





8-6 Automatic Water Fill Replacement Instructions (continued)

Step #	Operation Description	Visual Aids/Comments
 DANGER	Hazardous Voltage! Disconnect Power to Heater prior to performing this maintenance operation.	
6	<p>Note: The automatic water fill valve has an arrow stamped in the housing showing the direction of flow. The valve has to be installed with the arrow in the correct direction for the valve to operate properly.</p>	
7	<p>Apply pipe thread sealant to the threads of the fitting removed in step 5. Install the fittings and the new valve assembly on the heater as shown. Care should be taken to make sure no excess pipe sealant gets into the screen during assembly. This will result in reduced water flow. The brass elbow should point slightly forward.</p>	
8	<p>Using a pipe wrench or other suitable tool turn the tee approx. 1/4 turn counter-clockwise until the assembly is parallel with the rear of the furnace. Reinstall the flex line fitting and tighten hand tight plus approx. 1/2 turn. Do not over tighten the flex line to prevent damage to the inner bushing.</p>	
9	<p>Slide solenoid over valve stem and press firmly into place. Make sure spring retainer clip on solenoid latches into groove in top of valve stem.</p>	
10	<p>If replacing the solenoid strip wires approx. 1/2" and connect using wire nut suitable for 2 #16 AWG wires (orange) as shown. These wires are not polarity sensitive.</p>	

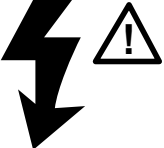

8-7 Honeywell Aqua Stat Replacement Instructions

Step #	Operation Description	Visual Aids/Comments
	<p>DANGER Hazardous Voltage! Disconnect Power to Heater prior to performing this maintenance operation.</p>	
1	<p>Using a 1/4" nut driver or flat head screwdriver loosen the cover screw located at the bottom of the thermostat and then remove cover.</p>	
2	<p>Loosen the two screws on the wire clamp and then using a flat head screwdriver depress the locking tabs holding the clamp in place. Gently pull the wire clamp down and away from the thermostat body.</p>	
3	<p>Pull on the thermostat capillary tube to make sure that the bulb has not been damaged during heater operation. Make sure the bulb is not lodged in the well fitting. If the bulb is lodged the well fitting will have to be replaced.</p>	
4	<p>Fold back the terminal block protector. Loosen the two screws on the terminal block and remove the two thermostat wires. Pull the wires through the wiring hole and lay aside.</p>	
5	<p>Loosen the two screws on the thermostat clamp. Gently lift the thermostat away from the well fitting. If the bulb is lodged in the well fitting cut the capillary tube using a wire cutter or other suitable tool. If the well fitting does not require replacement then skip to step # 10.</p>	

8-7 Honeywell Aqua Stat Replacement Instructions (continued)

Step #	Operation Description	Visual Aids/Comments
 DANGER	Hazardous Voltage! Disconnect Power to Heater prior to performing this maintenance operation.	
6	Open the heater tank drain valves and allow the furnace tank to drain until the tank water level is below the thermostat level.	
7	Using an adjustable wrench remove the well fitting from the rear of the furnace.	
8	Apply pipe joint compound to the threads of the new well fitting and then screw the fitting into the rear of the furnace. Use an adjustable wrench to tighten the fitting.	
9	Remove the cover from the new thermostat. Loosen the two screws on the thermostat clamp. Make sure the clamp is loose enough to slide over the notch in the well fitting.	
10	Slide the bulb into the well fitting. Position the thermostat so that the thermostat well hole is centered over the well, the thermostat is perpendicular to the ground and the clamp is engaged in the groove of the well fitting. Tighten the two well clamp screws. Do not over tighten the clamp screws.	

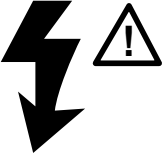
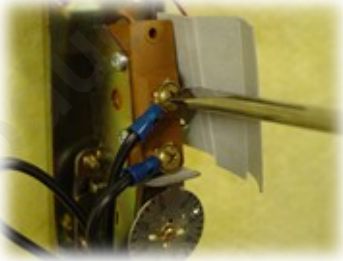
8-7 Honeywell Aqua Stat Replacement Instructions (continued)

Step #	Operation Description	Visual Aids/Comments
 <p>DANGER</p>	<p>Hazardous Voltage! Disconnect Power to Heater prior to performing this maintenance operation.</p>	
11	<p>Pull thermostat wires through wiring hole. Place terminals on studs in terminal block and tighten in place. Using a flat head screwdriver or other suitable object lift the locking tabs on the wire clamp then push the wire clamp into the wiring hole. Using a flat head screwdriver tighten the two clamp screws.</p>	
12	<p>Verify the thermostat temperature setting is correct. The correct value is written on the front cover. The dial can be adjusted using a flat head screwdriver.</p>	
13	<p>Replace the cover and tighten the cover screw.</p>	
14	<p>Reconnect power to furnace. If the water level was lowered to install a new well fitting, <u>MAKE SURE THE FURNACE IS FILLED WITH WATER TO THE CORRECT LEVEL BEFORE OPERATING HEATER.</u></p>	

Mountain View Hearth Products
manuals.stove-parts-unlimited.com

25 YEAR LIMITED WARRANTY

Hardy Manufacturing Co., Inc. (HARDY), hereby warrants that HARDY products shall be free from defect in material and workmanship under normal use according to the provisions and limitations herein set forth. HARDY warrants the Fire Box/Water Tank for five (5) years from the date of purchase by the original purchaser and pro rata thereafter according to the following schedule:

- * If the defect occurs to the tank during the sixth year, customer pays 20% of repair or replacement.
- * If the defect occurs to the tank during the seventh year, customer pays 35% of repair or replacement.
- * If the defect occurs to the tank during the eighth year, customer pays 50% of repair or replacement.
- * If the defect occurs to the tank during ninth year, customer pays 65% of repair or replacement.
- * If the defect occurs to the tank during the tenth year, customer pays 80% of repair or replacement.
- * If the defect occurs to the tank during the eleventh through twenty-fifth year, customer pays 85% of repair or replacement.

HARDY warrants catalytic combusters, if standard with furnace, for a period of three (3) years from the date of purchase by the purchaser.

HARDY warrants electrical and plumbing components for a period of one (1) year from date of purchase by the purchaser.

HARDY warrants all other Hardy Manufacturing products for a period of one (1) year from the date of purchase by the purchaser.

Limitations:

The obligation of HARDY for a breach of warranty shall be limited to products manufactured by HARDY 1) that are installed, operated and maintained according to HARDY's instructions, including Best Burn Practices, furnished and/or available to the purchaser upon request; 2) that are installed according to all other applicable Federal, State and local codes or regulations; and 3) that the purchaser substantiates products were defective in material and workmanship notwithstanding that they were properly installed and correctly maintained as set forth above and were not abused or misused.

The obligation of HARDY shall be limited to repairing or replacing the defective product, at the option of HARDY. HARDY shall not be responsible for any labor or cost removal or reinstallation of its products and shall not be liable for transportation costs to and from its plant in Philadelphia, Mississippi.

Use of parts for modification or repair of the product or any component part thereof not authorized or manufactured by HARDY specifically for such product shall void this warranty. Use of water in water tank that exceeds 45 ppm chloride content shall void warranty.

This warranty shall not apply to any damage to or defect in any of HARDY's products that is directly or indirectly caused by 1) force majeure, Act of God or other accident not related to an inherent product defect, or 2) abuse, misuse or neglect of such product, including any damage caused by improper assembly, installation, adjustment, service, maintenance, or faulty instruction of the purchaser.

Other than as expressly set forth herein above, HARDY makes no other warranty, express or implied, with respect to any of HARDY's products including but not limited to any warranty of merchantability or fitness for a particular purpose.

And in no event shall HARDY be responsible for any incidental or consequential damages of any nature suffered by purchaser or any other person of entity caused in whole or in part by any defect in any HARDY's products. Any person or entity to whom this warranty extends and who claims breach of warranty against HARDY must bring suit thereon within one year from the date of occurrence of such breach of warranty or by forever barred from any and all legal or other remedies for such breach of warranty.

HARDY is not responsible for and hereby disclaims any undertaking, representation or warranty made by any dealer, distributor or other person that is inconsistent with or in any way, more expansive than the provisions of this limited warranty. The return of warranty registration, with chloride test strip, to manufacturer is required to secure warranty validation.

This warranty grants specific legal rights and shall be read in conformity with applicable state laws. In some jurisdictions, the applicable law mandates warranty provisions that provide greater legal rights than those provided for herein. In such case, this limited warranty shall be read to include such mandated provisions and any provision herein that is prohibited or unenforceable in any such jurisdiction shall, as to such jurisdiction, be ineffective to the extent of such prohibition or unenforceable without invalidating the remaining provisions and without affecting the validity or enforceability of such provision in any other jurisdiction(s).

Effective Date: 1-1-2008 • Revision Date: 1-1-2008