



**INSTALLATION AND  
OPERATING INSTRUCTIONS**

**FOR**

**THE HARDY  
OUTSIDE WOOD  
BURNING HEATER**

*Model - KB165*

**HARDY MANUFACTURING  
COMPANY, INC.**

12345 ROAD 505

PHILADELPHIA, MS 39350

PHONE: (601) 656-5866

FAX: (601) 656-4559

*www.hardyheater.com*



Rev. 5/7/2015

Mountain View Hearth Products  
manuals.stove-parts-unlimited.com

THIS PAGE INTENTIONALLY LEFT BLANK

## INTRODUCTION

**Thank you** for purchasing the KB165 which is certified to the EPA 2015 Emission Standards. The KB165 is an all stainless steel Hardy Outside Wood Fired Hydronic Heater. It represents the result of many years of Hardy experience and the input of Hardy customers in the production of a top quality heater. With the purchase of this Hardy Heater, you can now appreciate the high degree of craftsmanship and reliability that have made “The Hardy” the leader in the Outside Wood Fired Hydronic Heater field. This manual will provide you with a good basic understanding of the installation and operation of this heater.

### **THIS MANUAL INCLUDES IMPORTANT SAFETY INFORMATION.**

Your new heater should have the following:

- (1) Owner’s manual complete with installation and hook-up instructions
- (2) Warranty & return warranty card
- (3) A tube of silicone (located in the firebox for shipping)
- (4) 2 double wall sections of smoke stack with a trim ring and cap
- (5) Condenser stack with trim ring
- (6) Ash shovel
- (7) 1.75” flue brush with handle
- (8) Panel and insulation to put between fire box door & ash door
- (9) Fire poker

Should your heater not have any of these items or if you have any questions regarding the operation or maintenance of your heater, please consult you local Hardy dealer.

Again, thank you for purchasing a Hardy Hydronic Heater.

**Sincerely,**  
Frank L. Moore  
President  
Hardy Manufacturing Co., Inc.

(MODEL KB165)

**Please fill in the following information**

**Hardy Model** \_\_\_\_\_

**Serial Number** \_\_\_\_\_

**Date of Purchase** \_\_\_\_\_

**Date of Installation** \_\_\_\_\_

**Dealer Purchased from** \_\_\_\_\_

**Dealer Address** \_\_\_\_\_

**Dealer Phone Number** \_\_\_\_\_

Please keep this manual with all other important papers. The information in this manual is necessary for the installation, operation and proper use of this unit. If you should ever have a problem or question please refer to this manual or have it available when you call your Hardy Dealer or Hardy Manufacturing Company, Inc.

**HARDY MANUFACTURING COMPANY, INC.**

12345 ROAD 505  
PHILADELPHIA, MS 39350  
PHONE: (601) 656-5866  
[www.hardyheater.com](http://www.hardyheater.com)

## **SAFETY PRECAUTIONS WARNING**

Do not operate this equipment for other than its intended purpose nor other than in accordance with the instructions contained in this manual and all other instructions accompanying the unit.

For units covered by this instruction book, it is important to observe safety precautions to protect yourself from possible injury. Among the many considerations, you are advised to:

- Observe all safety stickers on the unit.
- This unit must be wired by a qualified electrician in accordance with the National Electrical Code.
- Never use any type of petroleum based product, charcoal starter, lighter fluid, or any other flammable accelerant to start your unit.
- Fuel: Clean seasoned oak hardwood. Clean wood means wood that has no paint, stains, or other types of coatings, and wood that has not been treated with preservatives, including but not limited to, copper chromium arsenate, creosote, or pentachlorophenol.
- Never leave the door open, always latch the door securely.
- Always use proper care when installing, operating and maintaining the unit.
- Do not modify the unit.
- Do not substitute repairs which can be provided by your dealer, distributor, or Hardy Manufacturing Co. Inc.

Failure to heed this warning, any additional warnings on the unit, or instructions contained in this manual may result in an accident causing personal injury and/or loss of warranty.

Mountain View Hearth Products  
manuals.stove-parts-unlimited.com

THIS PAGE INTENTIONALLY LEFT BLANK

# OUTDOOR WOOD HEATER BEST BURN PRACTICES

1. Read and follow all operating instructions supplied by the manufacturer.
2. This heater is designed to burn natural wood only. Higher efficiencies and lower emissions generally result when burning air dried seasoned hardwoods, as compared to softwoods or to green or freshly cut hardwoods.
3. **FUEL USED:** Only those listed fuels recommended by the manufacturer of your unit.  
Never use the following: Garbage; Lawn clippings or yard waste; Materials containing rubber, including tires; Materials containing plastic; Waste petroleum products, paints or paint thinners, or asphalt products; Materials containing asbestos; Construction or demolition debris; Railroad ties or pressure-treated wood; Manure or animal remains; Salt water driftwood or other previously salt water saturated materials; Unseasoned wood; or Paper products, cardboard, plywood, or particleboard. The prohibition against burning these materials does not prohibit the use of fire starters made from paper, cardboard, saw dust, wax and similar substances for the purpose of starting a fire in an affected wood heater. Burning these materials may result in release of toxic fumes or render the heater ineffective and cause smoke."
4. **LOADING FUEL:** For a more efficient burn, pay careful attention to loading times and amounts. Follow the manufacturer's written instructions for recommended loading times and amounts.
5. **STARTERS:** Do not use lighter fluids, gasoline, or chemicals.
6. **LOCATION:** It is recommended that the unit be located with due consideration to the prevailing wind direction.
  - Furnace should be located no less than 100 feet from any residence not served by the furnace.
  - If located within 100 feet to 300 feet to any residence not served by the furnace, it is recommended that the stack be at least 2 feet higher than the peak of that residence.

## Chimney Height Installation Scenario

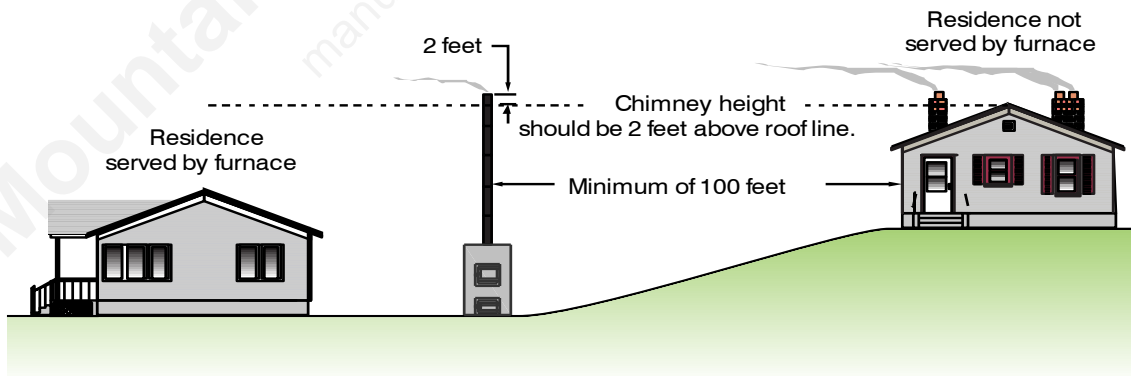

7. Always remember to comply with all applicable state and local codes.



OUTDOOR FURNACE MANUFACTURERS CAUCUS

(MODEL KB165)

V

## **THE HARDY OUTSIDE WOOD FIRED HYDRONIC HEATER**

### **How does an outside heater heat my home?**

The Hardy outside wood fired hydronic heater is designed to save the most energy and provide the most comfortable heating available. It heats your home by heating a stainless steel tank filled with water, which surrounds the firebox of the outside heater. The heater is a non pressurized boiler with an atmospheric vent. This hot water is then circulated through underground hot water pipes to a water coil inside your existing central duct system. The Hardy Heater can be connected to any existing hydronic heating system that operates at 170 degrees Fahrenheit or less.

### **How does THE HARDY heat water for household use?**

A plate heat exchanger (optional) is installed in the hot water circulator line. When you open a hot water faucet inside your home, the cold water passes through the other side of the heat exchanger and the water going to your hot water heater is preheated. The only additional energy required is maintaining the hot water temperature. The plate heat exchangers can be used for pools, dairies and other domestic hot water needs.

### **How do the Thermostat Controls work?**

The only visible addition to the heating system inside your home is the thermostat which is located next to your existing thermostat. The two thermostats are installed so that if the outside wood burning heater is not in operation, your existing unit can be used to maintain your household temperature. The wall thermostat which regulates the heat from the outside heater turns the blower on inside your central unit to force air across the hot coil. This forces hot air into your central duct system. The outside heater has a Process Control Module which senses the water temperature of the unit. This module cycles the heater on and off in order to maintain a preset water temperature.

### **Where should the Hardy Heater be located?**

The outside unit should be located at least 10 feet from your home, other structures or any other combustible materials so that all fire danger is removed. The unit may be installed as much as 100 feet away. If the unit is located more than 100 feet away, you may experience some heat loss on the water supplying your water heater. Locate the outside wood burning heater where it will be convenient for refueling. All water and power lines are installed underground between the house and the outside wood heater. Additionally refer to the Best Burn Practices section in this manual.

## Additional Installation and Operational Considerations

### Installation

Person(s) operating a Hardy hydronic heater must comply with all applicable laws or other requirements, such as state laws or regulations and local ordinances. Person(s) is/are also responsible for operation in a manner that does not create a public or private nuisance condition. The distance and stack height Hardy Mfg. recommends and the requirements in any applicable laws or other requirements may not always be adequate to prevent nuisance conditions due to terrain or other factors. This wood heater has a manufacturer-set minimum low burn rate that must not be altered. This wood heater needs periodic inspection and repair for proper operation. It is against federal regulations to alter this setting or otherwise operate this wood heater in a manner inconsistent with operating instructions in this manual. Operation in a manner inconsistent with the owner's manual will void the warranty.

### EPA's Burnwise Program

<http://www.epa.gov/burnwise>

### How to Use a Moisture Meter Video

<http://www.youtube.com/watch?v=jM2WGgRcnm0>

*EPA offers tips on how to properly use a moisture meter to test firewood before using in a wood-burning stove or fireplace. Wet wood can create excessive smoke which is wasted fuel.*

### Split, Stack, Cover and Store Video

<http://www.youtube.com/watch?v=yo1--Zrh11s>

*EPA offers four simple steps to properly dry firewood before using in a wood-burning stove or fireplace. Wet wood can create excessive smoke which is wasted fuel. Burning dry, seasoned firewood with a moisture content of 20% or less can save money and help reduce harmful air pollution.*

### Wet Wood is a Waste brochure

<http://www.epa.gov/burnwise/pdfs/wetwoodwastebrochure.pdf>

*This tri-fold brochure provides colorful illustrations of the four easy steps to dry firewood.*

## TABLE OF CONTENTS

SECTION I:	<b>General Information</b>	
	1-1 Specifications .....	1-2
	1-2 Heater Component Parts .....	3-5
SECTION II:	<b>Installation of Heater</b>	
	2-1 Location of Heater .....	6
	2-2 Chimney Connection .....	7
	2-3 Location of Plumbing & Electrical Lines .....	7
	2-4 Connection of Power to Heater .....	8
	2-5 Wiring Diagram .....	8-9
	2-6 Plumbing Connections .....	10
	2-7 Installation of Smoke Stacks and Condenser Stack	11
	2-8 Filling the Heater with Water .....	12
	2-9 Priming the Pump .....	13
SECTION III:	<b>Connection to Central Heating/AC System</b>	
	3-1 Connection to Central Unit with Existing Blower Relay .....	14-15
	3-2 Location of Heating Coil .....	16-17
SECTION IV:	<b>Connection to Hydronic Heating Systems (Baseboard)</b>	
	4-1 Connection to Hydronic System .....	18
SECTION V:	<b>Plumbing Options for Domestic Water</b>	
	5-1 Plate Heat Exchanger for Domestic Hot Water .....	19
SECTION VI:	<b>Heater Operation</b>	
	6-1 Firing the KB165 .....	20
	6-2 Loading the KB165 .....	21

## TABLE OF CONTENTS continued

<b>SECTION VII: Service Information</b>	
7-1 Water Temperature .....	22
7-2 Fuel Usage .....	22
7-3 Moisture in the Firebox .....	22
7-4 Improper Burning .....	22
7-5 Ash Removal .....	22
7-6 Water Circulation System .....	22
7-7 Combustion Air Blower Assembly.....	22
7-8 Air Volume Box .....	23
7-9 Low Water Float.....	23
7-10 Temperature Logic Controller .....	23
7-11 Low Water Lockout Relay .....	23
7-12 Timer.....	23
7-13 Time Delay Relay.....	23
7-14 Moisture Content of Wood.....	24
7-15 Fuel Usage .....	24
<b>SECTION VIII: Heater Maintenance</b>	
8-1 Weekly Maintenance.....	25
8-2 Monthly Maintenance.....	26
8-3 Extended Period Shut Down and Start Up.....	27
<b>SECTION IX: Appendix</b>	
9-1 General Trouble Shooting Guide .....	28-30
<b>SECTION X: Component Service / Replacement Procedure</b>	
10-1 Water Solenoid Valve .....	31-32
10-2 Low Water Float Switch .....	33-34
10-3 Pump .....	35-36
10-4 Damper Solenoid .....	37-38
10-5 Damper Solenoid Bracket .....	39
10-6 Air Volume Box Seal .....	40
10-7 Lockout Relay / Time Delay Relay .....	41
10-8 Temperature Logic Controller .....	42-43
10-9 Blower .....	44
10-10 Bypass Damper .....	45-46
10-11 Door Seals .....	47-49
10-12 Fire Box Door Latch Adjustment .....	50-51
<b>SECTION XI: Heater Repair Parts</b>	
11-1 Heater Repair Parts .....	53
Warranty Card Copy .....	55

Mountain View Hearth Products  
manuals.stove-parts-unlimited.com

---

---

## SECTION I

### GENERAL INFORMATION

This manual describes the installation and operation of The Hardy, Model KB165 Wood Fired Hydronic Heater, certified to the EPA 2015 Emission Standards.

This heater meets the 2015 U.S. Environmental Protection Agency's crib wood emission limits for wood heaters sold between May 15, 2015 and May 15, 2020.

Under specific test conditions this heater has been shown to deliver heat at rates ranging from 18,475 to 139,629 Btu/hr with efficiencies ranging from 53.4% to 68.5%.

This wood heater has a manufacturer-set minimum low burn rate that must not be altered. It is against federal regulations to alter this setting or otherwise operate this wood heater in a manner inconsistent with operating instructions in this manual. Operation in a manner inconsistent with the owner's manual will void the warranty.

#### **1 – 1        Specifications**

KB165 Hardy Wood Fired Hydronic Heater

##### For Outdoor Use Only

Type of fuel – Clean seasoned oak hardwood

Never use the following: Garbage; Lawn clippings or yard waste; Materials containing rubber, including tires; Materials containing plastic; Waste petroleum products, paints or paint thinners, or asphalt products; Materials containing asbestos; Construction or demolition debris; Railroad ties or pressure-treated wood; Manure or animal remains; Salt water driftwood or other previously salt water saturated materials; Unseasoned wood; or Paper products, cardboard, plywood, or particleboard. The prohibition against burning these materials does not prohibit the use of fire starters made from paper, cardboard, saw dust, wax and similar substances for the purpose of starting a fire in an affected wood heater. Burning these materials may result in release of toxic fumes or render the heater ineffective and cause smoke.

Wood Dimension & Condition -

22" to 24" in Length, 30% Moisture or less, Cured between 6 to 9 months.

Any round wood over 7" in diameter must be split at least once.

Wood Load Capacity -

10 to 15 pounds / cubic ft.

Firebox is approximately 13 Cubic Feet

Wood weight is approximately 130 to 195 pounds.



**1-2 Heater Component Parts  
Standard Components**

**Model KB165**

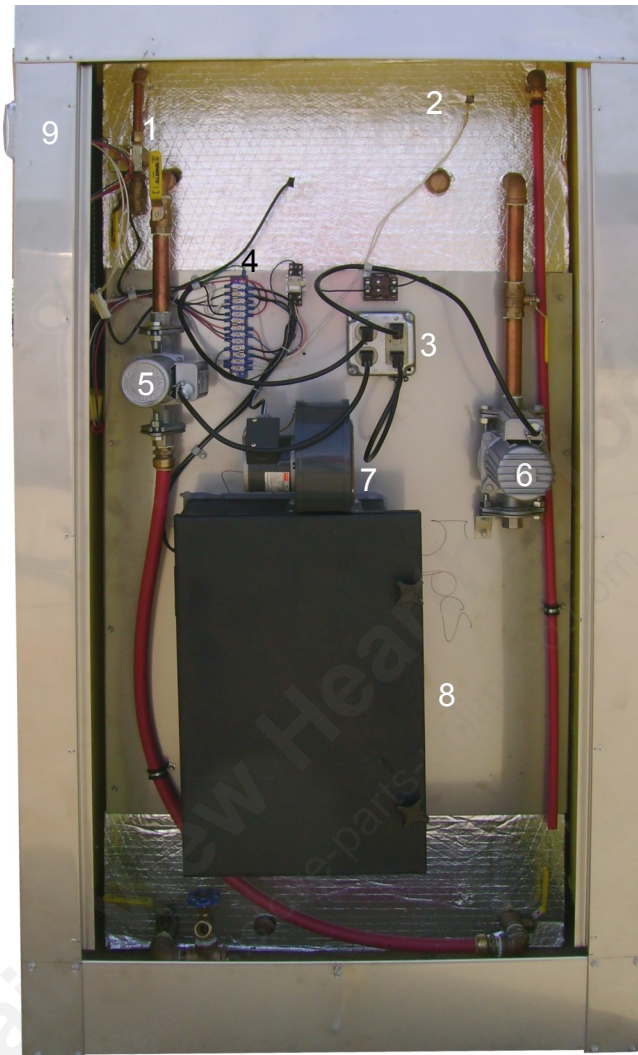

Legend	Part No.	Description
1	1100.00	Water Solenoid Valve Assembly
2	1100.28	SMD 1/2" Float Switch
3	2004.00	Ground Fault Interrupter Receptacle
4	2004.30	Terminal Block Assy.
5	508.50	Taco 008 SS pump
6	502.50	Taco 009 SS Pump
7	2002.69	1TDR6 Blower
8	7165.45	Air Volume Box
9	2065.10	Temperature Logic Controller

**1-2 Heater Component Parts      Model KB165**  
**Standard Components      (continued)**

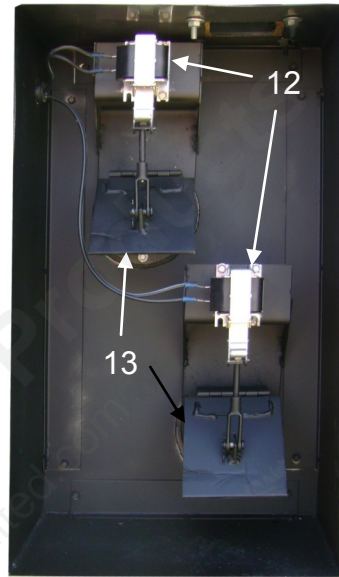

Inside of Air Volume Box

Legend	Part No.	Description
10	2065.50	Turbulators
11	7165.99	Bypass Damper
12	2001.05	Damper Solenoid
13	7165.40	Air Tube Damper Assy.

**1-2 Heater Component Parts      Model KB165**  
**Standard Components      (continued)**

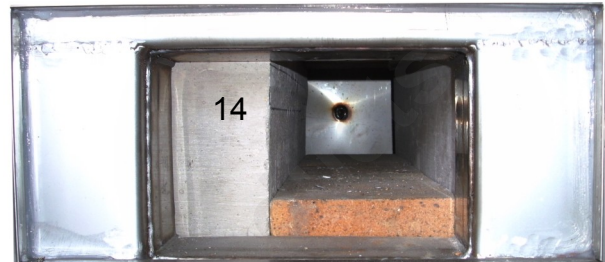
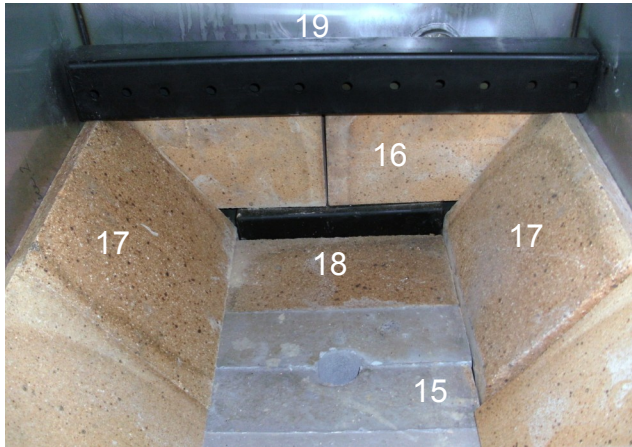

Legend	Part No.	Description
14	3105.18	Secondary Air Distribution Plenum
15	3105.17	Fire Grates
16	2165.27	Back wall brick
17	2165.28	Side Brick
18	2165.31	Bottom Front & Back Bricks
19	7165.20	Primary Air Distribution Plenum

---

---

## SECTION II

### INSTALLATION OF HEATER

#### 2-1 Location of Heater

The Hardy Heater is designed to operate outside the structure to be heated. The unit must be located a minimum of 10 feet from any structure.

The heating unit should be installed on a concrete pad with a recommended minimum dimension of 34"W x 61"L x 4"D. On the plumbing end of the heater you will need to bring up through the pad a 4" water tight chase pipe to route your water lines and electrical lines from the structure to be heated to the furnace.

Reference the illustration below for pad layout and ideal placement of 4" pipe.

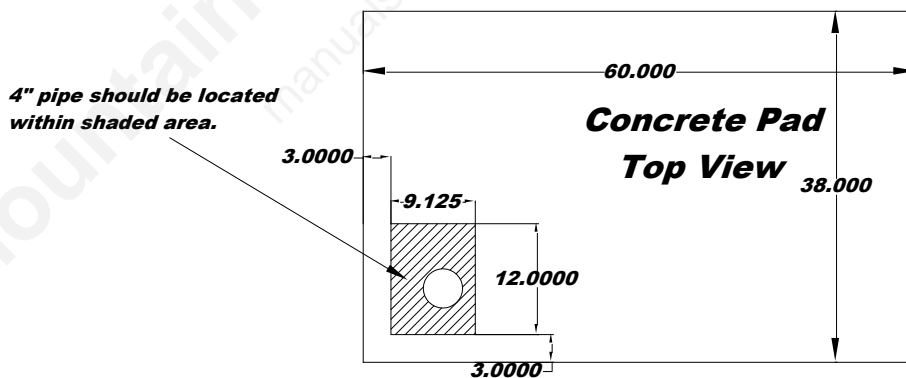

---

---

## 2-2 Chimney Connection

Do not connect this unit to a chimney flue servicing another appliance

## 2-3 Location of Plumbing & Electrical Lines

To locate the connection points for plumbing and electrical lines you will need to remove the rear access panel of the heater. The plumbing and electrical lines for your unit must be installed underground in a water tight pipe or other suitable insulation means. The water lines must be buried below the frost line to prevent freezing. Verify the correct depth according to local building codes prior to installation.

The installation will require a trench wide enough to accommodate a 4" water tight pipe or other insulation means. All plumbing and electrical lines should be installed inside the 4" water tight pipe or other insulation means for a standard installation. An additional pipe may be required if more than one zone or location is to be heated. If more than one location is to be heated, a second 4" or single 6" water tight pipe or other insulation means will need to be installed underground for the water lines and thermostat wires of the second location.

This pipe will run from the rear of the unit to the location to be heated. Contained inside the 4" watertight pipe is a minimum of two water lines and electrical supply wire. The listing below describes each line and related function.

1. One water supply line to heating system
2. One water return line from heating system  
(Note: The supply and return lines must be at least 3/4" pipe. 1" pipe may be required for longer distances. Some hydronic applications also require 1" pipe.)
3. One #12/2 w/gnd NM type UF underground wire

---

---

## 2-4 Connection of Power to Heater

**This unit must be wired by a qualified electrician  
in accordance with the National Electrical Code.**

Verify that all electrical power is turned off. Install a 20 amp circuit with #12/2 W/Gnd NM Type UF wire from the power source through the 4" watertight pipe or other means to the heater. This wire will connect to the "LINE" Terminals on the GFCI Receptacle located on the rear of the Heater. The breaker installed at the power source should be a 20 amp GFCI.

## 2-5 Wiring Diagram

**This equipment must be installed in accordance  
with the National Electrical Code.**

*( See wiring diagram next page )*



## 2-6 Plumbing Connections

### Connection to Heating System

1. The pipe that will supply the heating system is connected on the lower side of the pump ( Item 1).
2. The pipe that will carry the return water from the heating system is connected to the 1" fitting as shown in diagram below ( Item 2 ).

**Water pipes must be designed for hot water service (ex. copper, cpvc, or Pex A). Pipes should be installed in a 4" water tight pipe or some other type of insulating means to prevent heat loss from heater to heating system. Use only copper, brass, or stainless steel fittings. Do not use galvanized or black iron.**

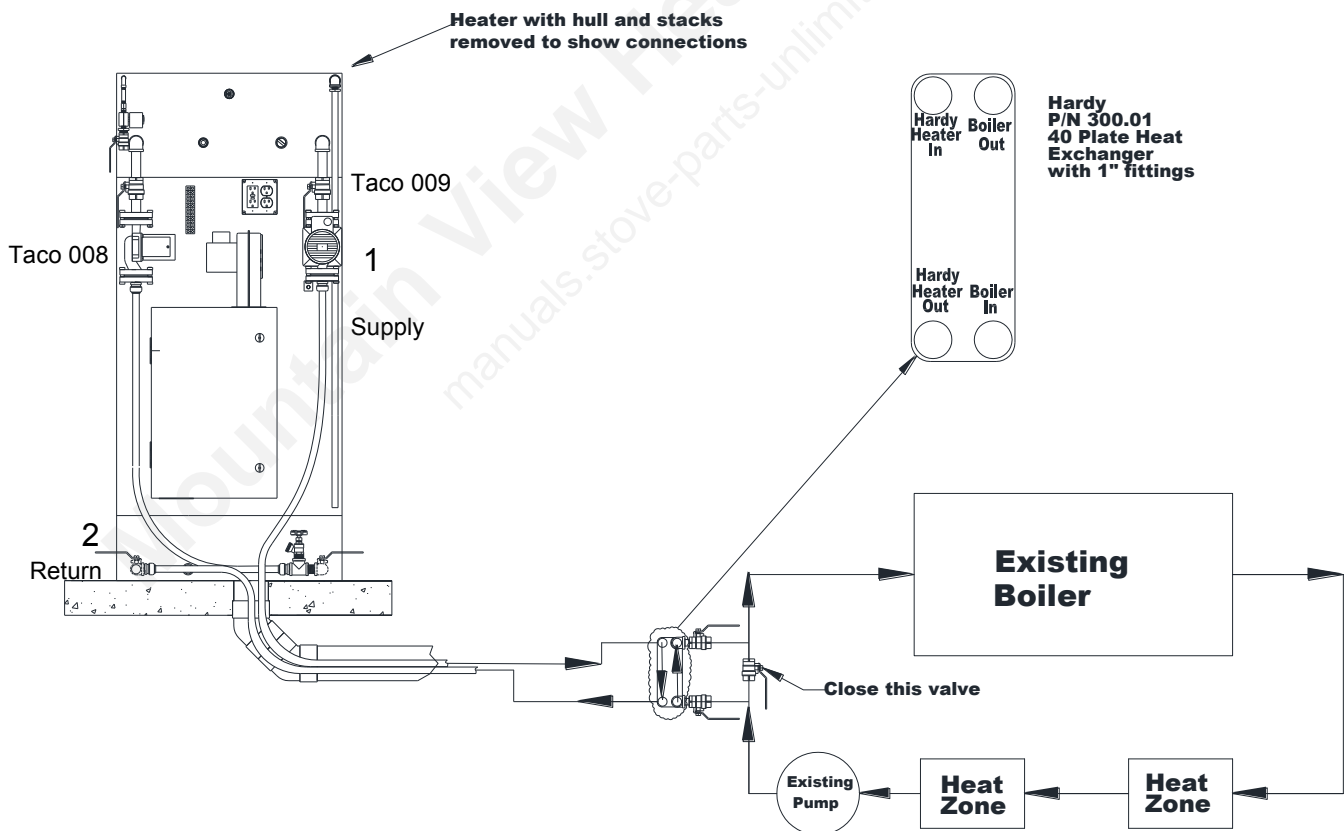

---

---

## 2-7 Installation of Smoke Stacks and Condenser Stack

The space between the smoke stack opening and outside cover will need a bead of silicone applied to fill any openings. The silicone is applied to prevent any water from entering the outside cover. The condenser tank will also need to be sealed in this manner. The application of silicone to these openings is illustrated by the diagram below.

After the silicone is applied, you can install the two three foot sections of smoke stack. The trim collar should slide down the smoke stack until it rests on the outside cover.

The condenser stack must also be installed in the condenser stack opening. The trim collar should slide down the condenser stack until it rests on the outside cover.

**DO NOT SEAL THE CONDENSER STACK TO THE WATER TANK CONDENSER STACK OPENING. THIS IS THE WATER TANK VENT AND MUST NOT BE SEALED.**

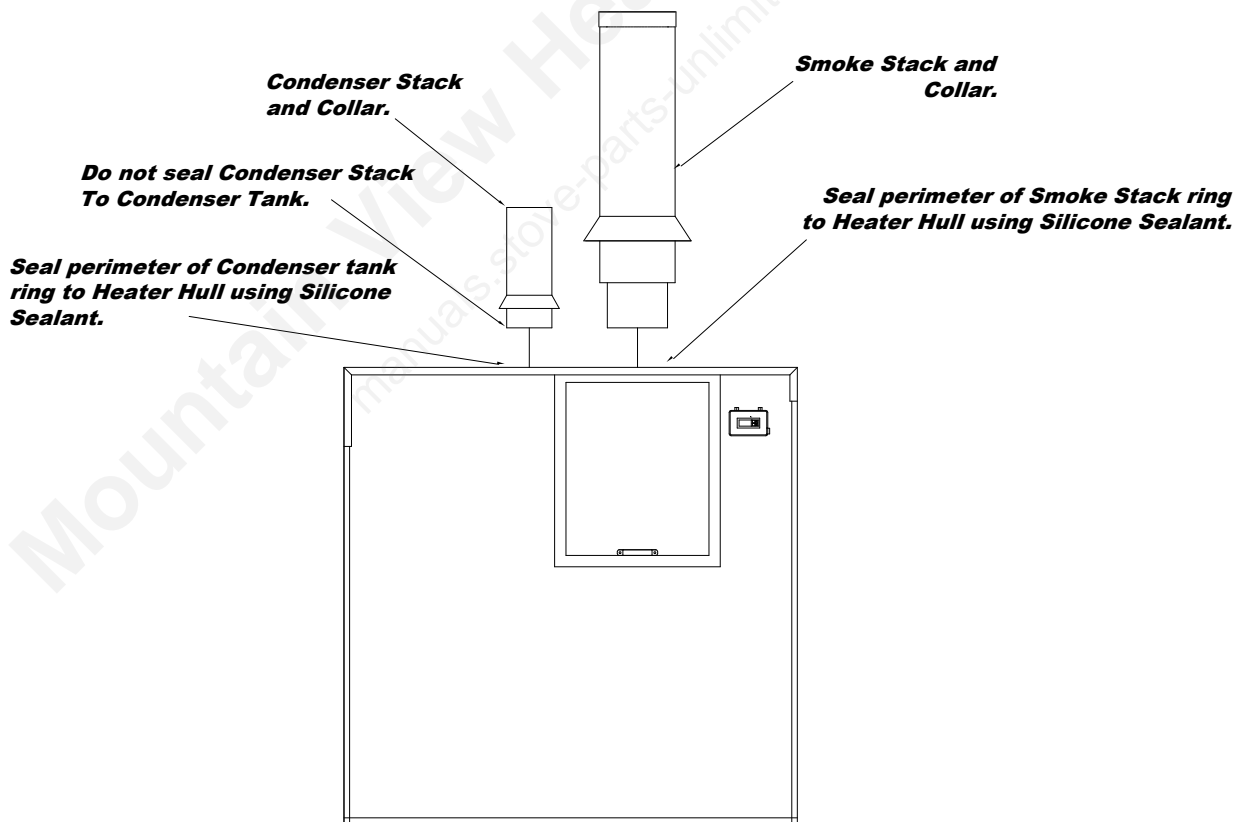

---

---

## 2-8 Filling the Heater with Water

### **The Hardy Hydronic Heater Must Be Filled with Water Before Operation**

There is a low water switch located in a fitting on the rear of the heater. This low water switch signals a low water condition in the process control module. The process control module will enable the automatic water fill valve assembly until the condition no longer exists. The heater will not operate while in a Low Water Condition.

There are certain parts of the country that have high enough levels of chloride in the water to be harmful to stainless steel tanks. Even though the USDA allows up to 250 parts per million of chloride (salt) in the water as acceptable for drinking, experience has shown that chloride levels as low as 45 parts per million will eventually cause stress corrosion cracking in stainless steel tanks when water is heated. It is therefore required to use rain water or bottled water with chloride content of less than 15 parts per million or test the water supply for chloride to assure that the water supply does not exceed 45 parts per million. Call your Hardy dealer to obtain a chloride test on your water supply. If the chloride content of your local water supply exceeds the specifications mentioned above and necessitates the use of bottled or rain water, please do so to maintain the warranty of your heater.

Fill your heater with water through the condenser stack opening until the water level is approximately 1" from the top of the tank.

---

---

## 2-9 Priming the Pumps

Once the furnace has been filled with water and the system pump has been connected to the house heating source, you will need to prime the pumps.

You will need to open the supply valves and the return valves on both pumps. Plug the power cord for the small circulator pump into the GFCI receptacle, and listen for the air bubbling back into the water tank. Once you no longer hear air bubbling, slowly close the supply valve above the pump until you hear a change in the sound the water makes as it flows through the pump. Once you are satisfied that the pump is moving water open the supply valve back up. Unplug the small circulator pump and follow the same steps with the larger heating-system pump. Once both pumps have been primed plug both power cords back in.

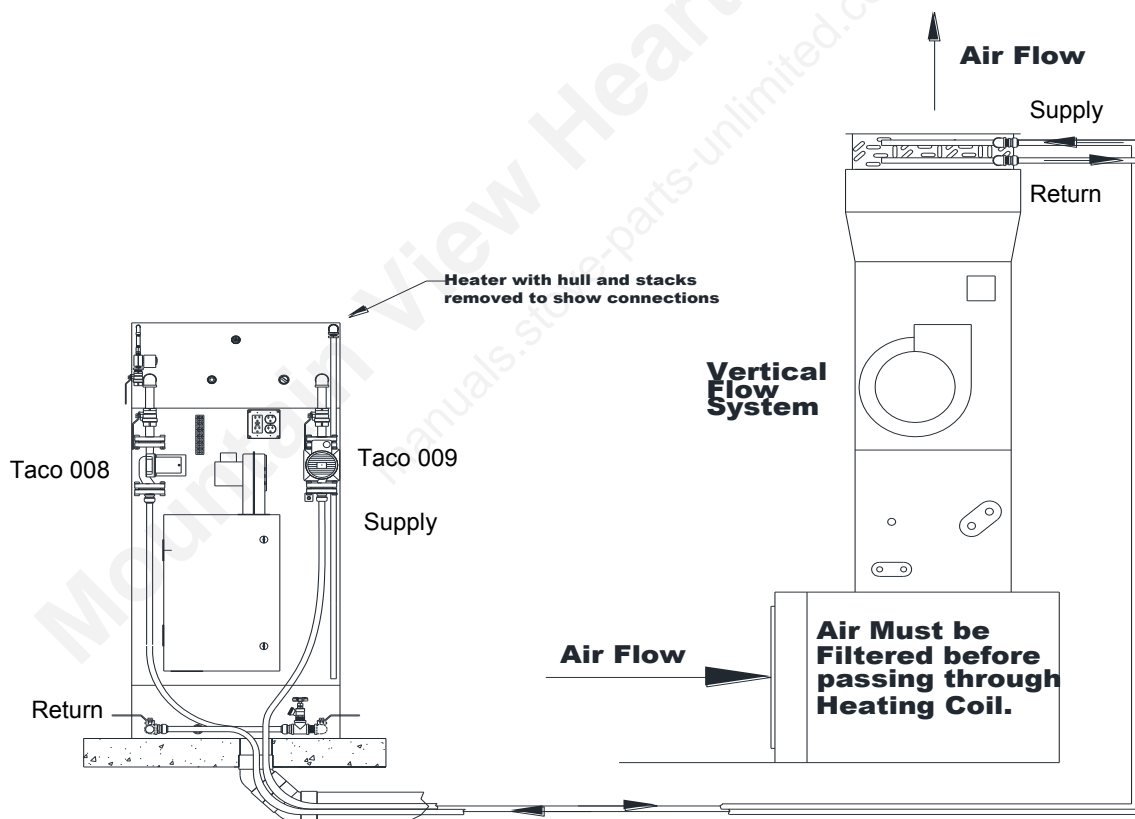

---

---

## SECTION III

### CONNECTION TO CENTRAL HEATING/AC SYSTEM

#### 3-1 Connection to Central Unit with Existing Blower Relay

**This unit must be wired by a qualified electrician in accordance with the National Electrical Code.**

Turn off all power going to your central air handler system.

You will need to add a double pole / double throw relay to your central air handler. You will also need a heat only thermostat added to the wall, preferably next to the existing thermostat. Run a two (2) conductor thermostat wire from the air handler to the new heat only thermostat that was added to the wall. The normal colors for this wire are red & white.

NOTE: If you are not familiar with the control circuit of your central unit, do not continue beyond this point. Call a heating and air conditioning serviceman to complete the wiring. Improper wiring can cause excessive electrical usage or cause your blower motor to over heat and burn out.

At the wall heat only thermostat connect the red wire to the screw terminal marked R and the white wire to the screw terminal marked W.

At the central air handler where you added the relay, connect the white wire that is going to the new heat only wall thermostat to terminal #7 of the new relay along with a short jumper wire that will connect to terminal #6 of the new relay. Next find the red wire going from the air handler control wiring to the original wall thermostat. Cut this wire and connect the end that is going to the wall thermostat to terminal # 2 on the new relay. The end of the red wire that is still connected to the control wiring of the air handler will need to be connected to terminal # 1 along with the new red wire that is going to the new heat only wall thermostat.

Locate the green wire going from the central air handler control wiring to the original wall thermostat. Cut this wire. Connect the end of the green wire that is going to the original wall thermostat to terminal #5 of the new relay. Connect the end of the green wire that is still connected to the central air handler control wiring to terminal #4.

Locate the low voltage transformer that is providing you with 24 volt power. Find the common lead of this transformer and connect a wire to this lead and to terminal #8 of the new relay.

### 3-1 Connection to Central Unit with existing Blower Relay (continued)

#### CONNECTION DIAGRAM

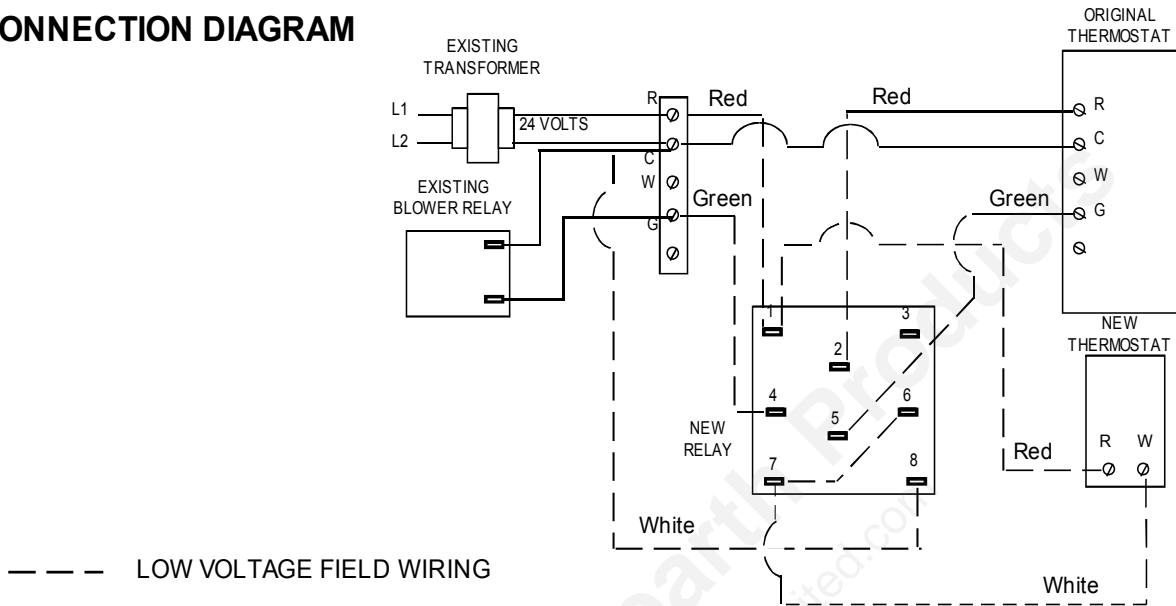

#### SCHEMATIC DIAGRAM

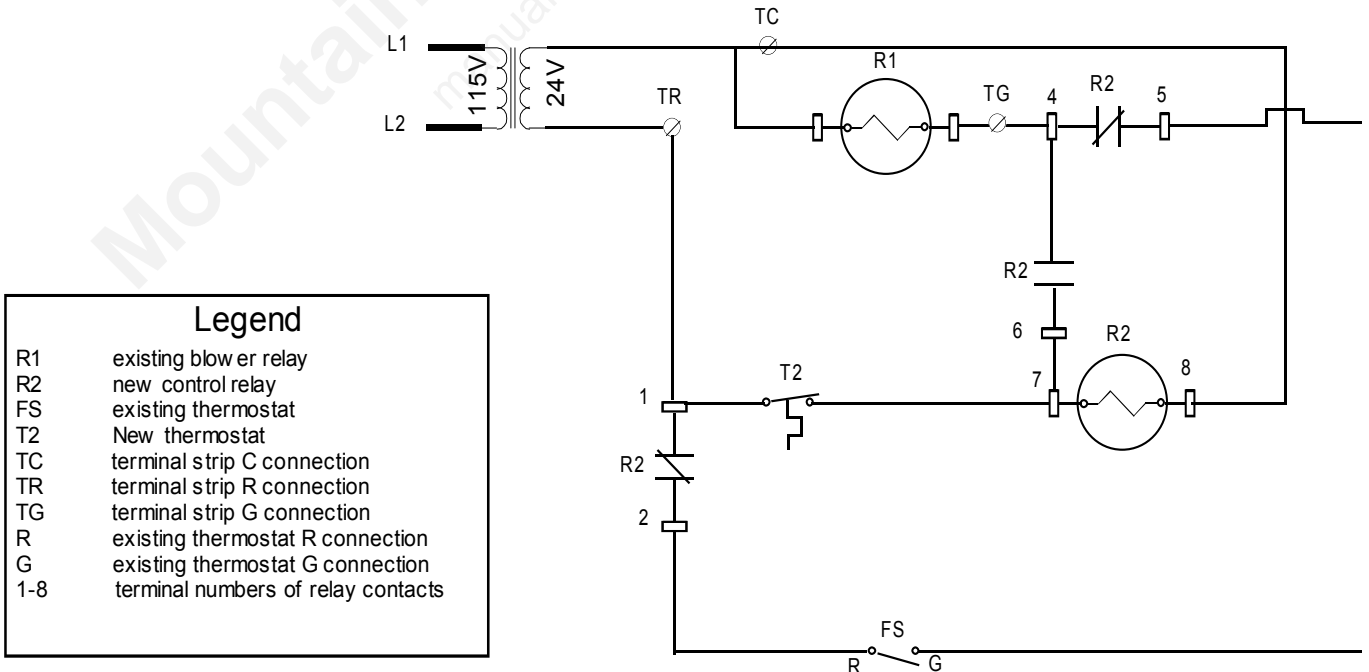

---

---

### 3-2 Location of Heating Coil

The following diagrams and pictures on this page and the following page show various methods of installing the heating coil in a forced air system.

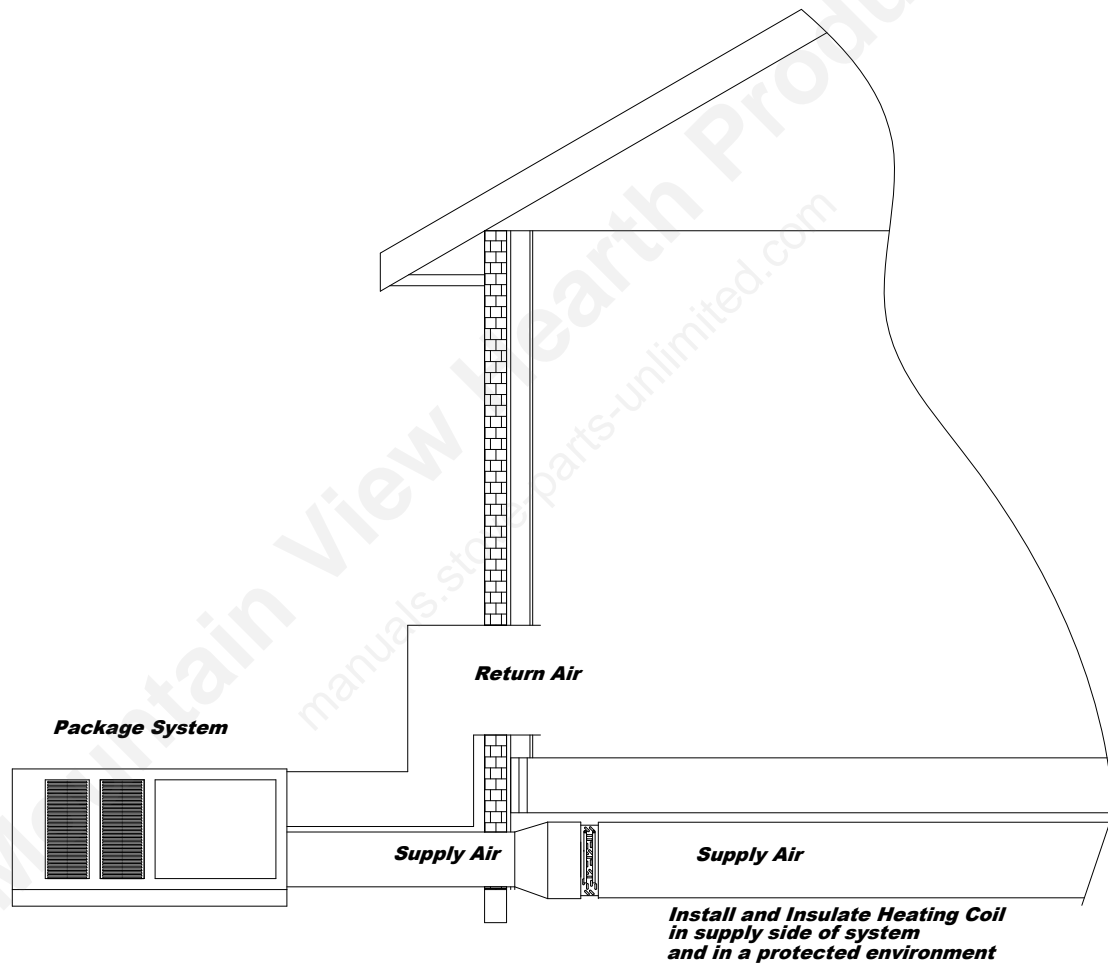

3-2 Location of Heating Coil (continued)

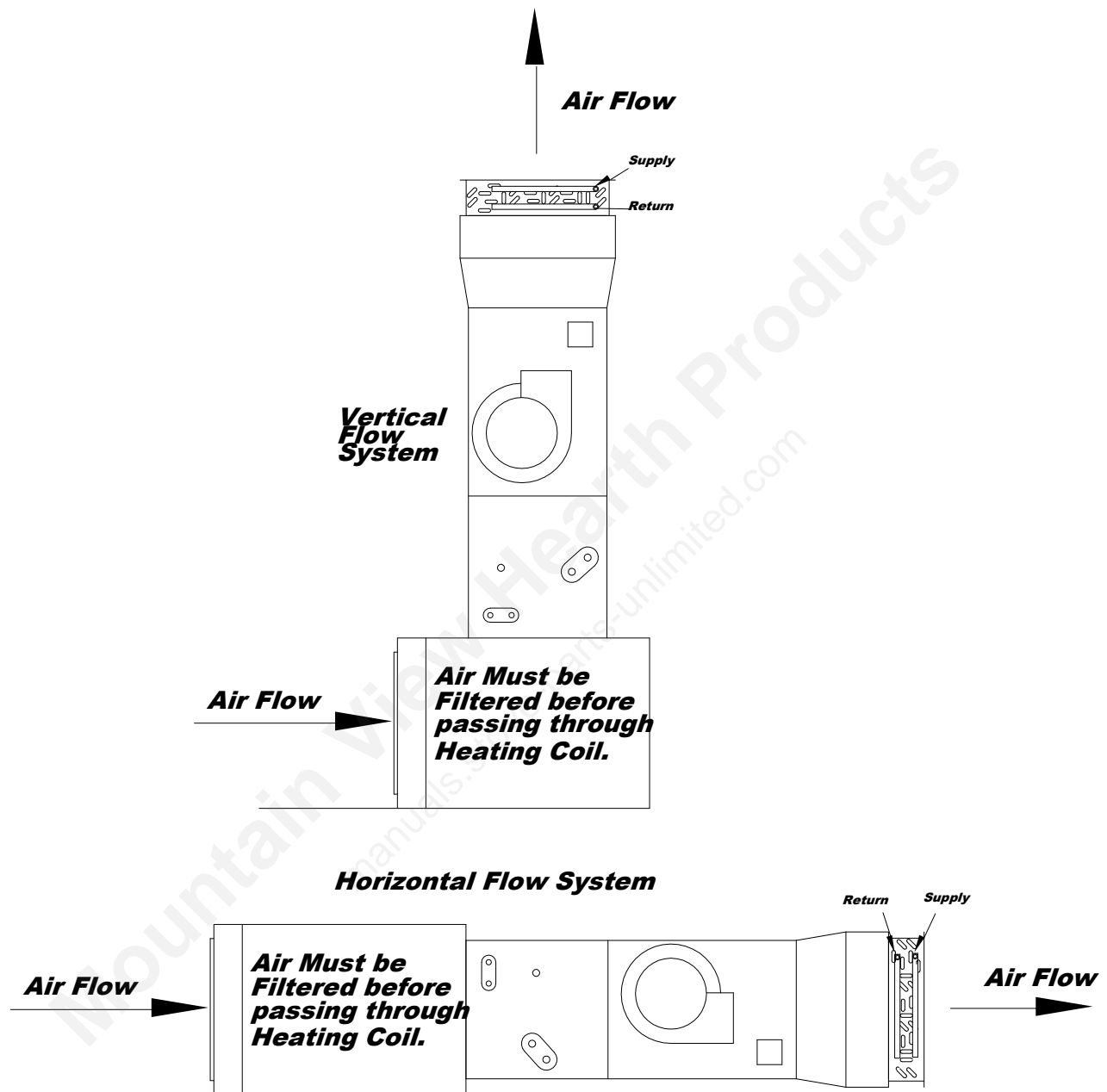

## SECTION IV

### CONNECTION TO HYDRONIC HEATING SYSTEMS (BASEBOARD)

#### 4-1 Connection to Hydronic System

**This unit must be wired by a qualified electrician in accordance with the National Electrical Code.**

The preferred method for connecting the Hardy KB165 Hydronic Heater to an existing hydronic system is by installing a p/n 300.01 (40 plate heat exchanger w/ 1" fittings) into the return line of the existing boiler system. Run 2 -1" potable hot water lines from the wood heater to the existing hydronic system. Connect these lines to the plate heat exchanger so that the water flow of the wood heater is opposite of that from the existing hydronic system.

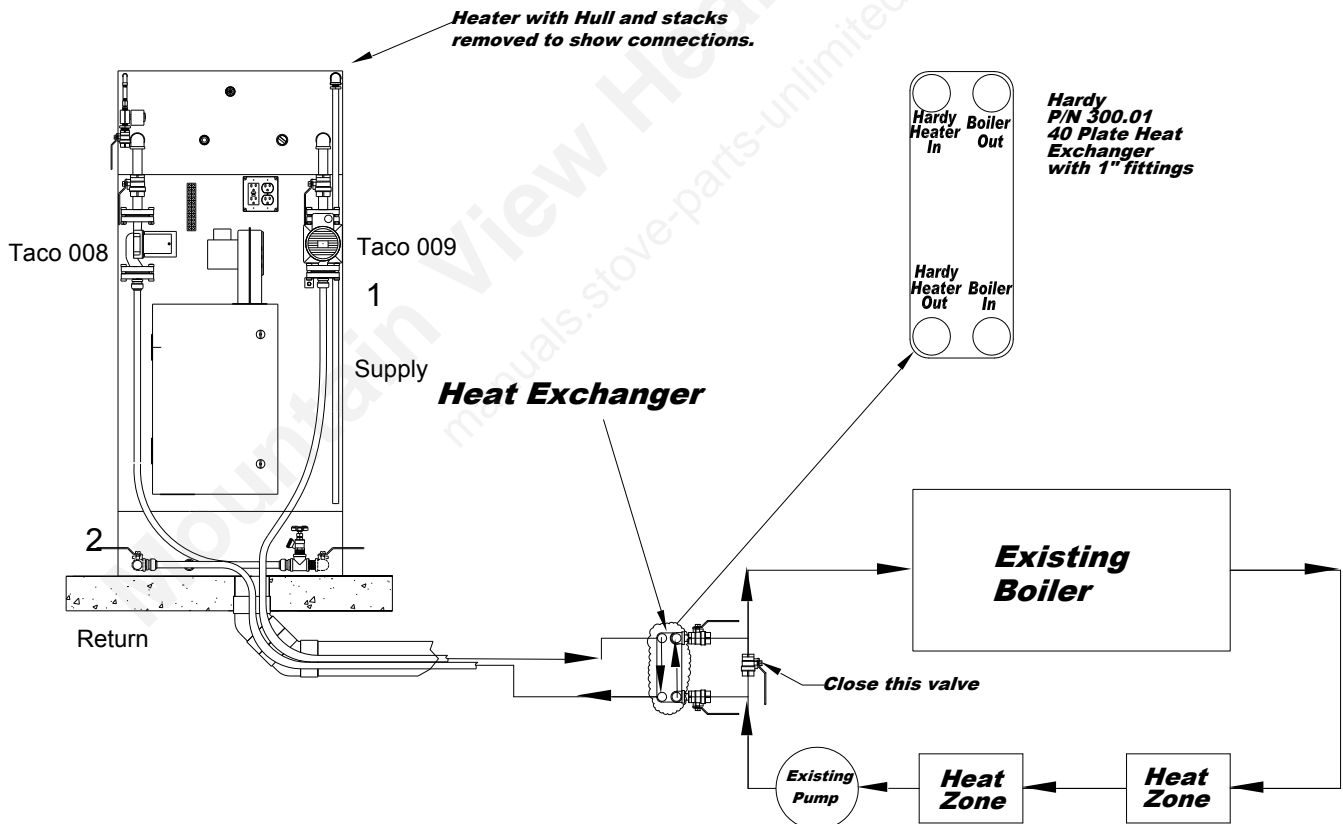

## SECTION V

### PLUMBING OPTIONS FOR DOMESTIC WATER

#### 5-1 Plate Heat Exchanger for Domestic Hot Water

To add domestic hot water to the KB165 hydronic heater, a plate heat exchanger and pump can be added. This plate heat exchanger will provide preheated water to the domestic hot water. The preferred method is to mount a plate heat exchanger at the water heater and connect it as shown in the following drawing. The pump will circulate heater water through the plate continuously. The cold water supply will need to be connected to the opposite side of the plate heat exchanger and flowing in the opposite direction for maximum efficiency. The alternate method would be to mount the plate heat exchanger on the back of the wood heater and connect the water heater to the plate the same way as in the preferred method with the water flowing in opposite directions.

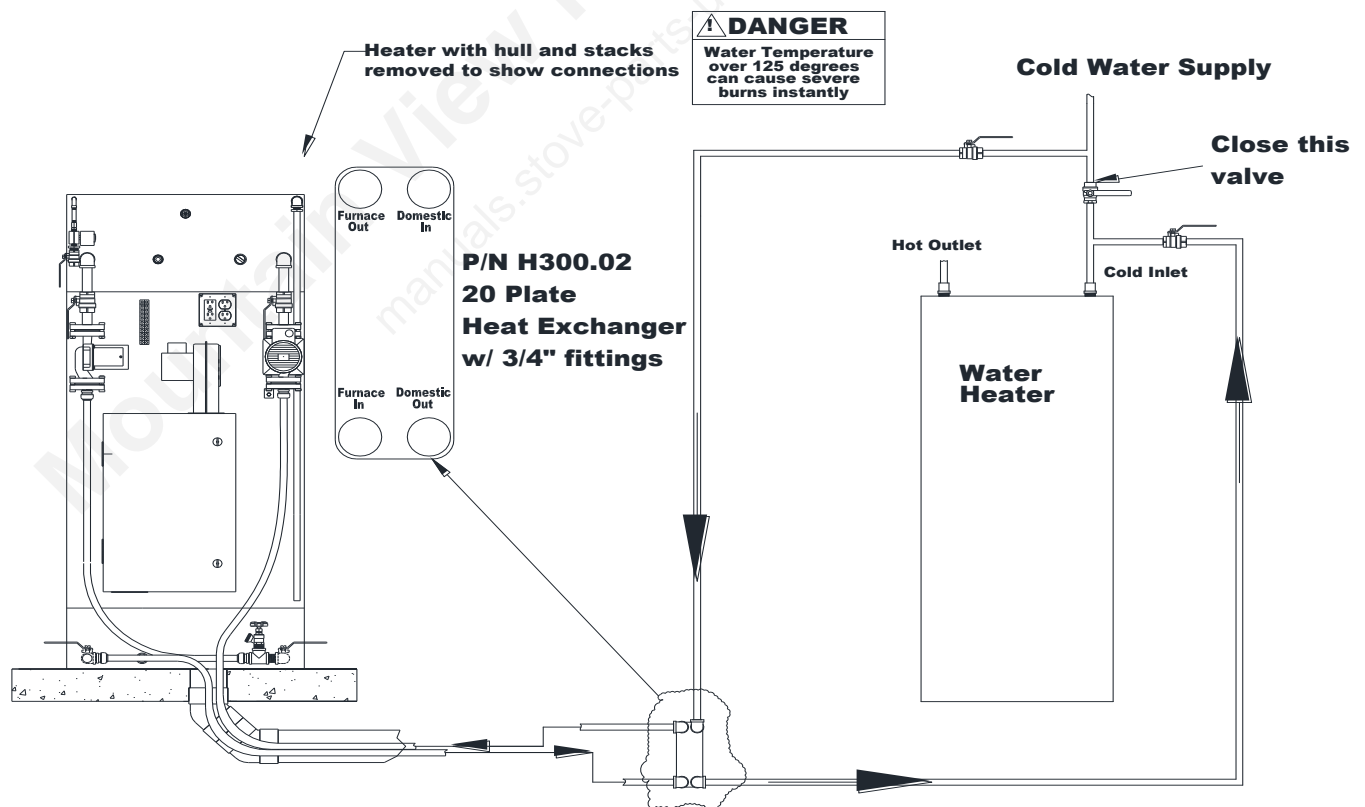

---

---

## SECTION VI

### HEATER OPERATION

#### 6-1 Firing the KB165

Hardy Manufacturing recommends burning clean seasoned oak hardwood in this heater: Clean Wood means wood that has no paint, stains, or other types of coatings, and wood that has not been treated with preservatives, including but not limited to, copper chromium arsenate, creosote, or pentachlorophenol.

- 22" to 24" in length
- 30% moisture or less
- Cured between 6 to 9 months

Heater is ready to install from the factory.

The following steps should be completed to light and operate the heater unit:

1. Once the heater has been installed, unplug the two pumps on the back of the heater.
2. Fill the heater with water by turning on the heater. The automatic fill valve will begin to fill the tank with water which holds approximately 130 gallons.
3. Once heater is full of water, prime pumps following procedure outlined in section 2-8, (once primed you can leave main heating pump unplugged to allow heater to reach operating temperature quicker).
4. Open the bypass damper (located on the front right side of the heater).
5. Put paper in the firebox over the grates.
6. Add approximately 10 lbs of small kindling on top of the paper.
7. Light the paper and then close the firebox door.
8. Let it burn between 15 to 20 minutes.
9. Open the firebox door and add 6 to 8 sticks of 2" to 4" split wood.
10. Close the firebox door.
11. Close the bypass damper and let the heater run between 30 to 40 minutes.
12. Open the bypass damper, then open the firebox door and stir the fire.
13. Once coal bed is established, load the heater firebox half full of wood.
14. Close the firebox door, and then close the bypass damper. (Temperature will begin rising).
15. After one hour, open the bypass damper and then the firebox door.
16. Fill the heater firebox with wood.  
Wood should be loaded from front to back and stacked as uniform in the firebox as possible. DO NOT attempt to load wood across the width (crossways) of the firebox.
17. Close the firebox door and then the bypass damper.
18. Plug in the system pump on the back of heater.

---

---

## 6-2 Loading the KB165

The following steps should be completed to load the KB165 Hardy Heater:

1. Open the bypass damper (located on the right side of the firebox door).
2. Open the firebox door.
3. Flip the blower switch off (located on the right side of the heater), light will turn on. This will begin the off delay timer that is set for 8 minutes.
4. Open the ash door and shovel the ashes out with the provided shovel.  
Ashes should be placed in a metal container with a tight fitting lid.  
The closed container of ashes should be placed on the ground away from any combustible materials, pending final disposal. The ashes should be retained in the closed container until all cinders have thoroughly cooled.
5. Rake the coals around in the firebox, making sure all air holes in the back air tube are open with the provided fire poker.
6. Confirm that the two 2" holes in the fire grates are open.
7. Load the heater firebox with the amount of wood needed for your application.  
*(For Example: Using an average load of approximately 74,000 BTU/HR, the heater firebox should be loaded with approximately 135 pounds of wood with an average moisture content of 20% for an 8 hour burn.)*  
Wood should be loaded from front to back and stacked as uniform in the firebox as possible. DO NOT attempt to load wood across the width (crossways) of the firebox.
8. Close the ash door.
9. Close the firebox door.
10. Close the bypass damper.
11. Flip the blower switch on, light will turn off. Keep in mind that the off delay timer could still be timing.

---

---

## SECTION VII

### SERVICE INFORMATION

#### 7-1 Water Temperature

The tank water temperature is maintained by the Temperature Logic Controller. The normal operating temperature of 175° F to 180° F is preset at the factory and should not be adjusted.

#### 7-2 Fuel Usage

Hardy Manufacturing recommends the use of clean seasoned oak (hardwood). Any fuels other than those specified will result in poor and erratic heater performance. This heater is designed to use a minimum amount of fuel but as with any heater of this type fuel usage is based upon the required load and temperature requirements.

#### 7-3 Moisture in the Firebox

During startup of a new heater or the first time you operate an existing heater each year, you will probably notice moisture in the firebox. This is normal and should not cause alarm.

#### 7-4 Improper Burning

Improper burning during the normal operation of the heater is normally caused by lack of combustion air or fuel in the firebox chamber.

#### 7-5 Ash Removal

Ashes must be removed from inside the heater on a routine basis. Excessive ash buildup inside the Firebox and recovery chambers will reduce heating efficiency. Remove ashes with the provided shovel. Ashes should be placed in a metal container with a tight fitting lid. The closed container of ashes should be placed on the ground away from any combustible materials, pending final disposal. The ashes should be retained in the closed container until all cinders have thoroughly cooled. Refer to section 8-1 Weekly Maintenance Instructions for ash removal.

#### 7-6 Water Circulation System

The water circulation system circulates heated water from the heater to the structure to be heated.

#### 7-7 Combustion Air Blower

The combustion air blower supplies air into the air volume box.

---

---

## **7-8 Air Volume Box**

The air volume box contains the upper & lower air tube dampers. These dampers control the amount of air and distributes the air where it is needed for a proper burn.

## **7-9 Low Water Float**

The low water float signals a low water condition in the Temperature Logic Controller. The heater will not operate if a low water condition exists.

## **7-10 Temperature Logic Controller**

The Temperature Logic Controller monitors water temperature as well as water level of the heater.

## **7-11 Low Water Lockout Relay**

The low water lockout relay turns all combustion systems off until the heater fills with water.

## **7-12 Timer (delay on break)**

When the Temperature Logic Controller satisfies or the control switch is switched off it begins timing. This prevents short cycling of the unit.

## **7-13 Time Delay Relay**

The time delay relay is energized by the timer. It turns off the control power to draft dampers and the blower.

---

---

## 7-14 Moisture content of wood

Seasoned wood is wood that has air dried until it's moisture content is between 15% and 30% moisture level. Seasoning hard wood can take six months to one year, depending on the climate you live in and the moisture content of the wood when it was cut. Winter cut wood usually has a moisture content around 50% while wood cut during the growing season will be much higher.

The best way to tell if your firewood is ready to use would be to use a moisture meter. To test a piece of firewood for it's moisture content, first split a seasoned log. Using the supplied moisture meter take sample readings across several locations of the split side and average the readings. If moisture level is between the recommended 15% to 30% levels your firewood is ready for use.

Steps to take moisture readings:

1. Remove "protective cap" from top of meter and attach to the bottom side.
2. Press and hold power switch to turn meter on.
3. If your meter has different modes set the mode switch to wood.
4. Insert the "measuring pins" as deep into the split side of the firewood as possible.
5. Read the values on the readout.
6. Take several different readings and average them.

## 7-15 Fuel Usage

Hardy Manufacturing recommends the use of clean seasoned oak hardwood. Any fuels other than this will result in poor and erratic heater performance. This heater is designed to use a minimum amount of fuel but as with any heater of this type fuel usage is based upon the required load and temperature requirements. Using seasoned hardwood instead of wood with high moisture content or softwood, will allow the unit to operate more efficiently at high burn rates, as well as low burn rates that are generally less efficient due to BTU consumption and heater cycles. The 8 hour output with higher heating value is rated at 61.7%. While using an annual efficiency rating a 57.4% was determined during testing. These ratings are the results of four different operational tests (weighted, not averaged) that determine heater characteristics during simulated real world use. Using a correctly rated heater for your application and seasoned hardwood will ensure you achieve a "sweet spot" of efficiency.

You may use fire starters made from paper, cardboard, saw dust, wax and similar substances for the purpose of starting a fire. Burning these materials may result in release of toxic fumes or render the heater ineffective and cause smoke.

It is recommended that any building serviced by this heater or adjacent to this heater be equipped with smoke detectors and carbon monoxide monitors as tests have indicated this heater produces a weighted average of 22.61 lbs/mmbtu CO that could potentially seep through improperly sealed building or other construction materials.

---

---

## SECTION VIII

### HEATER MAINTENANCE

The Hardy heater is designed for ease of operation and ease of service. There is a minimal amount of maintenance that has to be done for proper operation of your new unit.

#### 8-1 Weekly Maintenance

The following steps should be completed weekly to clean the KB165 Hardy Heater:

1. Burn down wood in the firebox to a coal bed.
2. Open the bypass damper (located on the right side of the firebox door).
3. Open the firebox door.
4. Flip the blower switch off (located on the right side of the heater), light will turn on. This will begin the off delay timer that is set for 8 minutes.
5. Open the ash door and shovel the ashes out with the provided shovel. Ashes should be placed in a metal container with a tight fitting lid. The closed container of ashes should be placed on the ground away from any combustible materials, pending final disposal. The ashes should be retained in the closed container until all cinders have thoroughly cooled.
6. Stir the coal bed in the firebox with the provided fire poker.
7. Poke out the holes in the grates, verifying the loose powder ash has been raked down through the grates with the provided fire poker.
8. Load the heater with the amount of wood needed for your application.  
*(For Example: Using an average load of approximately 74,000 BTU/HR, the heater firebox should be loaded with approximately 135 pounds of wood with an average moisture content of 20% for an 8 hour burn.)*  
Wood should be loaded from front to back and stacked as uniform in the firebox as possible. DO NOT attempt to load wood across the width (crossways) of the firebox.
9. Close the ash door.
10. Close the firebox door.
11. Close the bypass damper.
12. Flip the blower switch on, light will turn off. Keep in mind that the off delay timer could still be timing.

---

---

## 8-2 Monthly Maintenance

The following steps should be completed monthly to clean the KB165 Hardy Heater:

1. Burn down wood in the firebox to a coal bed.
2. Open the bypass damper (located on the front right side of the heater).
3. Open the firebox door.
4. Flip the blower switch off (located on the right side of the heater), light will turn on. This will begin the off delay timer that is set for 8 minutes.
5. Rake the coals around, pushing any coal or burning wood to the right hand side of the firebox with the provided fire poker.
6. Remove the powder ashes from the left side of the firebox with the provided shovel.
7. Move coal and burning wood to the left side of the firebox with the provided shovel.
8. Remove the powder ashes on the right side of the firebox with the provided shovel.
9. Open the ash door and remove the ashes with the provided shovel.  
Ashes should be placed in a metal container with a tight fitting lid.  
The closed container of ashes should be placed on the ground away from any combustible materials, pending final disposal. The ashes should be retained in the closed container until all cinders have thoroughly cooled.
10. Close the ash door.
11. Open the upper right hand side flue box door on the heater.
12. Remove the tubulators out of each 2" tube.
13. Push the provided 1.75" flue brush down each hole.
14. Put the tubulators back in each 2" tube.
15. Close the right hand side door.
16. Remove left hand side door and clean out the combustion chamber with the provided shovel.
17. Put the left hand side door back on.
18. Load the heater firebox with the amount of wood needed for your application.  
*(For Example: Using an average load of approximately 74,000 BTU/HR, the heater firebox should be loaded with approximately 135 pounds of wood with an average moisture content of 20% for an 8 hour burn.)*  
Wood should be loaded from front to back and stacked as uniform in the firebox as possible. DO NOT attempt to load wood across the width (crossways) of the firebox.
19. Close the ash door.
20. Close the firebox door.
21. Make sure all other doors are closed.
22. Close the bypass damper.
23. Flip the blower switch on, light will turn off. Keep in mind that the off delay timer could still be timing.

---

---

## 8-3 Extended Period Shut Down and Start Up

### Extended Period Shut Down Procedure

1. Preplan when you want to shut your system down.
2. Allow the heater to operate until all fuel in firebox burn chamber is consumed and has cooled down.
3. Turn off power to the heater. Turn off system control switch; also turn off supply breaker from power source.
4. Perform normal monthly maintenance schedule (see monthly maintenance schedule section 8-2).

### Start Up of Heater After Extended Shut Down.

1. Verify no creosote, ash or other debris is obstructing air flow into or out of the combustion air blower; air distribution tubes, secondary heat recovery tubulators, or smoke stacks.
2. Confirm all door gasket seals are clean and secured to form an air tight seal onto the door frame.
3. Refer to Section 6-1 & 6-2 instructions

---

---

## Section IX Appendix

### 9-1 TROUBLE SHOOTING GUIDE

#### Improper Burning

1. Verify that the two (2) holes in the grates are open.
2. Make sure that the holes in the air tube located across the rear of the fire box are open and unrestricted.
3. Open the ash door and empty the ashes in the ash drop.
4. Take out the turbulators in the top right side chamber of the heater and brush out the tubes with the 1.75" flue brush provided.
5. Clean out the bottom left side chamber with the shovel provided.
6. Open the air volume box on the back of the heater and make sure that the top and bottom air inlets are clear of any creosote.
7. Verify that the dampers and blower are operating properly.

Mountain View Hearth Products  
manuals.stove-parts-unlimited.com

## 9-1 TROUBLE SHOOTING GUIDE (CONTINUED)





Problem	Causes	Solutions
Moisture in firebox	To wet of wood being burned	Burn 30% or less moisture wood
	To much wood in firebox	Fill the heater with the proper amount of wood for your application
	Coal bed burning out	Maintain a proper level coal bed
Coal bed burning out	To large of wood	Burn smaller wood so the coal bed will be replenished
	Wood is rotted	Rotted wood will not form a coal bed so proper wood needs to be burned
	Burning soft wood	Soft wood will not form a coal bed, you can mix soft wood with hardwood or either burn the right moisture hardwood
Unit smokes	Improper air (stopped up)	Clean primary and secondary air tubes in the air volume box Make sure the air holes in the primary air tube are open Perform the weekly maintenance (section 7)
	Unit is dirty	Perform weekly maintenance (section 7)
	Combustion blower	Clean blower wheel for any dirt buildup
	Damper solenoids	Verify that solenoids are working when power is applied Change out solenoid if powered up and not operating
	Air leakage	Check and seal any leakage around the air volume box
	Bad air volume box gasket	Inspect the foam gasket and replace as needed

## 9-1 TROUBLE SHOOTING GUIDE (CONTINUED)



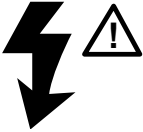

Problem	Causes	Solutions
Unit smokes (continued)	Bypass damper leaking	Change out the bypass damper gasket
	Bypass damper staying opened	Clean creosote away from the damper lid so it will shut properly  Replace the closure spring if needed
Unit will not come on	Power lose	Check with volt meter for power between terminals 1 and 4 on the terminal strip for 120 vac  Reset incoming power
	Combustion blower switch	Check with volt meter for power between terminals 1 and 5 on the terminal strip for 120 vac  No power flip switch and test again. Still no power replace switch
	Float switch	Check to see if low water light is illuminated on the temperature logic control  Check to see if heater is full of water (add water if needed)  Change the float if the heater is full of water and the float will not open
	Lockout relay	Check with volt meter for power between terminals 1 and 7 on the terminal strip for 120 vac  If power is there and relay is not energized replace relay
	Time Delay relay	Check with volt meter for power between terminals 1 and 8 on the terminal strip for 120 vac  If power is there and relay is not energized replace relay
	Time Delay Control	Check with volt meter for power between terminal 1 on the terminal strip and each of the connections on the time delay control for 120 vac  If power is on one terminal but not on the other replace time delay control.

## Section X Component Service / Replacement Procedure

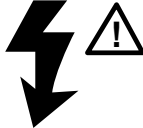

### 10-1 Water Solenoid Valve

Step #	Operation Description	Visual Aids/Comments
 <b>DANGER</b> Hazardous Voltage! Disconnect Power to Heater prior to performing this maintenance operation.		
1	If you are replacing only the water fill solenoid coil, cut wires to automatic water fill approx. 4" to 6" from solenoid coil.	
2	Firmly pull solenoid coil away from valve as shown.	
3	To continue in changing the whole water fill assembly, you need to use an adjustable wrench and a back up wrench. Note: the fitting above the valve is a swivel fitting and can be turned to remove valve.	
4	Remove the 1/2" ball valve, the 1/4" X 1/2" brass bushing, and the 1/4" close nipple from old valve.	

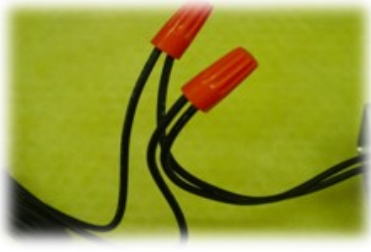

10-1 Water Solenoid Valve (continued)

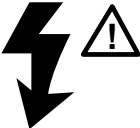
Step #	Operation Description	Visual Aids/Comments
 <p><b>DANGER</b> Hazardous Voltage! Disconnect Power to Heater prior to performing this maintenance operation.</p>		
5	Clean the screen inside the 1/2"x1/4" Brass Bushing prior to re-installation using warm soapy water.	
6	<p>Note: The Automatic Water Fill Valve has an arrow stamped in the housing showing the direction of flow. The valve has to be installed with the arrow in the correct direction for the valve to function properly. Apply pipe thread sealant to the threads of the fittings removed in the previous steps.</p>	 <p>Direction of flow arrow</p>
7	Install the fittings and the new valve assembly on the furnace in reverse of steps used to remove. Care should be taken to make sure no excess pipe sealant gets into the mesh screen during assembly. This will result in reduced or no water flow through the valve.	
8	Replace solenoid coil onto the valve assembly and splice the wiring together with suitable size wire nuts.	

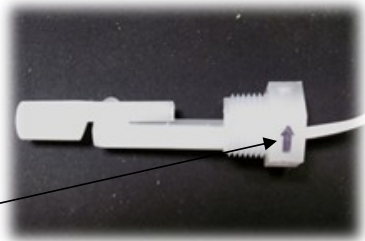
10-2 Low Water Float Switch

Step #	Operation Description	Visual Aids/Comments
 <p><b>DANGER</b> Hazardous Voltage! Disconnect Power to Heater prior to performing this maintenance operation.</p>		
1	Make sure the heater has cooled down before attempting to change out the float. Open the tank drain valves until the water level is below the float switch.	
2	Cut the switch wires approx. 6 inches from the rear of the the float switch.	
3	Using an adjustable wrench or other suitable tool remove the float switch from the furnace.	
4	Looking at the wrench flats on the switch there are two directional arrows located on the side as shown. For the switch to operate correctly it will have to be oriented with the arrow pointed down when installed.	 <p style="text-align: center;">Arrow</p>

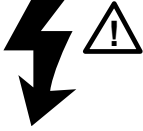

10-2 Low Water Float Switch (continued)

Step #	Operation Description	Visual Aids/Comments
	 <b>DANGER</b> <b>Hazardous Voltage! Disconnect Power to Heater prior to performing this maintenance operation.</b>	
5	<p>Apply pipe joint compound liberally around the threads of the switch. Using an adjustable wrench or other suitable tool install the switch in the tank. Do not overtighten. Make sure the switch is oriented with the arrow pointing down.</p>	
6	<p>Connect new switch wiring to existing wiring using suitable wire nut.</p>	
7	<p>Reconnect power to furnace. On models with the automatic water fill option allow the unit to fill above the float switch. If the automatic water fill and low water indicator does not turn on, or if it turns on but does not shut off when the water reaches the correct level the switch is possibly not oriented correctly.</p>	



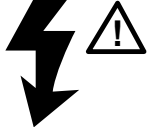

10-3 Pump

Step #	Operation Description	Visual Aids/Comments
 <p><b>DANGER</b> Hazardous Voltage! Disconnect Power to Heater prior to performing this maintenance operation.</p>		
<p><b>Testing/Replacing Pump Cartridge</b></p>		
1	Close the pump inlet and return ball valves to prevent water flow.	
2	Loosen and remove the four(4) 7/16" screws from the pump motor housing.	
3	Gently pull the pump motor housing toward you and turn so you can view pump impellar.	
4	Rotate the pump impellar by hand. If the impellar will not spin freely then replace the cartridge.	
5	Reassemble in reverse order.	



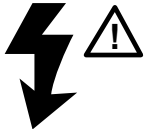

10-3 Pump (continued)

Step #	Operation Description	Visual Aids/Comments
<div style="display: flex; align-items: center;">  <div> <p><b>DANGER</b> <b>Hazardous Voltage! Disconnect Power to Heater prior to performing this maintenance operation.</b></p> </div> </div>		
<b>Testing Pump Capacitor</b>		
1	Remove top cover to expose electrical connections.	
2	If using an analog Ohm meter, check the resistance across the two capacitor leads. The meter should immediately read "0" Ohms then slowly drift to infinity. Reverse the test leads and check meter reading. The test procedure is the same for a digital multimeter except the meter will show some resistance then return to "OL" (open line). To replace Capacitor, cut away existing wire nut connectors. Strip leads and connect with wire nut connector suitable for two(2) 16 AWG wires.	
3	Replace cover.	
<b>Testing Pump Motor Winding</b>		
1	Disconnect power cord from motor wiring. Using an Ohm meter or continuity tester, check the continuity across each power wire and also check each power wire to ground. If the the pump does not show continuity across the two power wires or if either power wire shows continuity to ground the winding is defective and the pump should be replaced.	



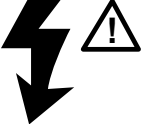

10-4 Damper Solenoids

Step #	Operation Description	Visual Aids/Comments
 <b>DANGER</b> Hazardous Voltage! Disconnect Power to Heater prior to performing this maintenance operation.		
1	Disconnect wires from damper solenoid.	
2	Remove retaining clip from connecting pin in the yoke assembly.	
3	Remove connecting pin from yoke assembly.	
4	Straighten ends of cotter pin through upper end of the connecting rod.	

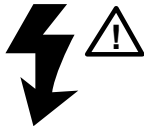
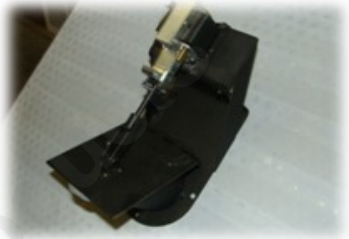
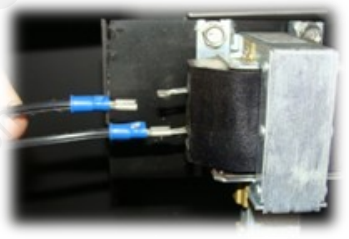

10-4 Damper Solenoids (continued)

Step #	Operation Description	Visual Aids/Comments
 <p><b>DANGER</b> Hazardous Voltage! Disconnect Power to Heater prior to performing this maintenance operation.</p>		
5	Remove cotter pin , remove connecting rod and yoke and set aside to be reinstalled on new damper solenoid.	
6	Using a 5/16" nut runner, remove all mounting screws.	
7	Mount new solenoid and reinstall connecting rod and yoke assembly in the reverse order that they where removed. Check for proper mechanical operation by lifting solenoid plunger by hand to see that travel up and down is smooth.	

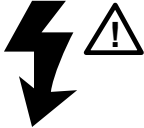

## 10-5 Damper Solenoids Bracket

Step #	Operation Description	Visual Aids/Comments
 <b>DANGER</b> Hazardous Voltage! Disconnect Power to Heater prior to performing this maintenance operation.		
1	Damper solenoid bracket assembly.	
2	Disconnect wires from solenoid and remove solenoid from bracket assembly following steps in section 10-4 Damper Solenoid.	
3	With a 5/16" nut runner, remove the 3 mounting screws from the sides and bottom of the damper solenoid bracket assembly.	
4	Replace gasket with the new gasket provided and mount the new solenoid bracket in the reverse order of removal.	
5	Remount the damper solenoid and connection rod assembly following steps in section 10-4 Damper Solenoid.	
6	Reconnect wiring.	



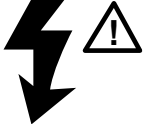

10-6 Air Volume Box Seal

Step #	Operation Description	Visual Aids/Comments
 <b>DANGER</b> Hazardous Voltage! Disconnect Power to Heater prior to performing this maintenance operation.		
1	To reseal air volume box door first clean off old gasket to bare metal.	
2	Using a self adhesive 1/2" X 1/2" X 62" foam gasket, line the inside of the door.	
3	Using a caulking gun apply a bead of silicone caulk to the inside edge of the foam gasket.	
4	Also apply a bead of silicone caulk to the outside edge of the foam gasket.	
5	Allow the silicone to cure before closing door.	

10-7 Lockout Relay / Time Delay Relay

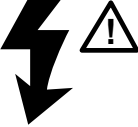
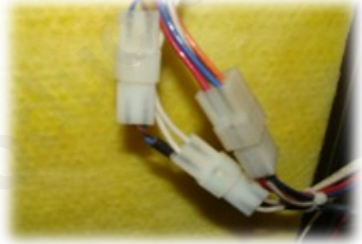
Step #	Operation Description	Visual Aids/Comments
	 <b>DANGER</b> <b>Hazardous Voltage! Disconnect Power to Heater prior to performing this maintenance operation.</b>	
1	To replace either relay, pull the old relay straight out from the relay socket.	
2	Insert the new relay into the relay socket, being sure to align the relay connecting pins with the corresponding slots in the relay socket.	







10-8 Temperature Logic Controller

Step #	Operation Description	Visual Aids/Comments
 <p><b>DANGER Hazardous Voltage! Disconnect Power to Heater prior to performing this maintenance operation.</b></p>		
1	<p>Disconnect the 3 Pin &amp; Socket connectors on the wiring in the rear of the temperature logic controller.</p>	
2	<p>On each side of the temperature logic controller there is a mounting clip that must be depressed and held to slide off the rear of the temperature logic controller. You must depress the front edge of the locking tab.</p>	 <p>Depress here</p> <p>slide rearward →</p>
3	<p>Slide the temperature logic controller out the hull.</p>	
4	<p>Feed the wiring harness of the new temperature logic controller back through the hull.</p>	





10-8 Temperature Logic Controller (continued)

Step #	Operation Description	Visual Aids/Comments
 <b>DANGER</b> Hazardous Voltage! Disconnect Power to Heater prior to performing this maintenance operation.		
5	Slide the controller into the hull until it is flush with the cover plate.	
6	Slide the mounting clips back onto the temperature logic controller until they hold the controller firmly in place.	<p>Front of controller</p> 
7	Reconnect the 3 Pin & Socket connectors on the wiring in the rear of the temperature logic controller. Take care to match the wiring on these connectors.	



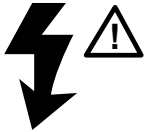

10-9 Blower

Step #	Operation Description	Visual Aids/Comments
 <p><b>DANGER</b> Hazardous Voltage! Disconnect Power to Heater prior to performing this maintenance operation.</p>		
<b>Cleaning blower</b>		
1	<p>The curved vanes of the blower wheel may require cleaning occasionally. Scrape out any build up with a screw driver. Take care not to knock loose any balancing weights, if any, on the blower wheel.</p>	
<b>Replacing blower</b>		
2	<p>Remove cover on blower motor wiring box. Disconnect power cord wires from the motor wires.</p>	
3	<p>Unbolt the 4 - 1/4" bolts that mount the blower to the Air volume box and remove the old gasket.</p>	
4	<p>Replace the gasket with the new gasket supplied and bolt the new blower to the air volume box.</p>	
5	<p>Wire the power cord to the new blower motor.</p>	

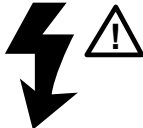

10-10 Bypass Damper

Step #	Operation Description	Visual Aids/Comments
 <b>DANGER</b> Hazardous Voltage! Disconnect Power to Heater prior to performing this maintenance operation.		
1	Open the Bypass damper.	
2	Open the flue box door on the right side of the heater.	
3	Remove the pin clip on the damper arm where it is connected to the pull rod connectors.	
4	Pull the pin out of the damper arm.	

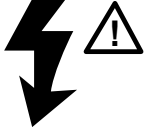

10-10 Bypass Damper (continued)

Step #	Operation Description	Visual Aids/Comments
 <b>DANGER</b> Hazardous Voltage! Disconnect Power to Heater prior to performing this maintenance operation.		
5	Pull the hinge pin from the hinge on the bypass damper.	
6	Clean the old gasket from the mouth of the bypass channel.	
7	Clean off the bypass damper face.	
8	Reseal the mouth of the bypass channel with silicone and 1" flat fiberglass rope gasket material. And remount the by pass damper in the reverse order of removal.	



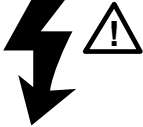

10-11 Door Seals

Step #	Operation Description	Visual Aids/Comments
 <b>DANGER</b> Hazardous Voltage! Disconnect Power to Heater prior to performing this maintenance operation.		
<b>Replacing Fire Box Door Gasket</b>		
1	Allow heater to burn out all wood and coals before performing this procedure.	
2	Remove old seal with a screwdriver and scrape out all silicone. Wire brush the seal area.	
3	Using a caulking gun lay a small bead of silicone in the bottom of the seal groove.	
4	Starting at one corner insert the 5/8" X 64" silicone impregnated fiberglass rope.	



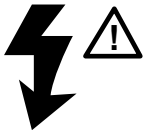

10-11 Door Seals (continued)

Step #	Operation Description	Visual Aids/Comments
<div style="display: flex; align-items: center;">  <div> <p><b>DANGER</b> Hazardous Voltage! Disconnect Power to Heater prior to performing this maintenance operation.</p> </div> </div>		
<b>Replacing Fire Box Door Gasket</b>		
5	Push the rope into the seal groove until rope is approximately 1/4" below the edge of the door.	
6	Fill in any voids with silicone. Allow to cure before closing door.	
<b>Replacing Ash Door Gasket</b>		
1	Follow the same procedure for the ash door seal as you would for the fire box door seal with the exception that you will use a standard white 5/8" X 48" fiberglass rope.	

10-11 Door Seals (continued)

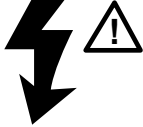
Step #	Operation Description	Visual Aids/Comments
<div style="display: flex; align-items: center;">  <div> <p><b>DANGER</b> Hazardous Voltage! Disconnect Power to Heater prior to performing this maintenance operation.</p> </div> </div>		
<b>Replacing Combustion Door Gasket</b>		
1	Remove the combustion door.	
2	Clean the old gasket off to bare metal.	
3	Lay a generous bead of silicone in the center of the area of the gasket. Spread the silicone to a thickness of 1/8".	
4	Starting at one edge lay the 1/4" X 1" X 40" flat rope gasket on top of the silicone and work all the way around the door. Press the rope onto the silicone to assure good adhesion.	
<b>Replacing Flue Door Gasket</b>		
1	Follow the same procedure for the Flue door seal as you would for the combustion door seal with the exception that you will use a 1/4" X 1" X 66" flat fiberglass rope.	

## 10-12 Fire Box Door Latch Adjustment

Step #	Operation Description	Visual Aids/Comments
 <b>DANGER</b> Hazardous Voltage! Disconnect Power to Heater prior to performing this maintenance operation.		
1	After replacing door gaskets you may need to adjust the door latch tension. Allow heater to burn out all wood and coals and to cool down before attempting this procedure.	
2	To adjust door tension remove both acorn nuts on outside of door latch.	
3	To increase tension loosen both outside nuts on the latch adjustment bolts.	
4	Tighten the inside nuts on the latch adjustment bolts. You should only adjust these approximately one complete revolution at a time.	
5	To decrease tension loosen both inside nuts on the latch adjusting bolt.	

10-12 Fire Box Door Latch Adjustment (continued)

Step #	Operation Description	Visual Aids/Comments
 <b>DANGER</b> Hazardous Voltage! Disconnect Power to Heater prior to performing this maintenance operation.		
6	Tighten both outside nuts on the latch adjustment bolt.	
7	Replace both acorn nuts and tighten.	

Mountain View Hearth Products  
manuals.stove-parts-unlimited.com

THIS PAGE INTENTIONALLY LEFT BLANK

## Section XI Heater Repair Parts

### 11-1 Heater Repair Parts

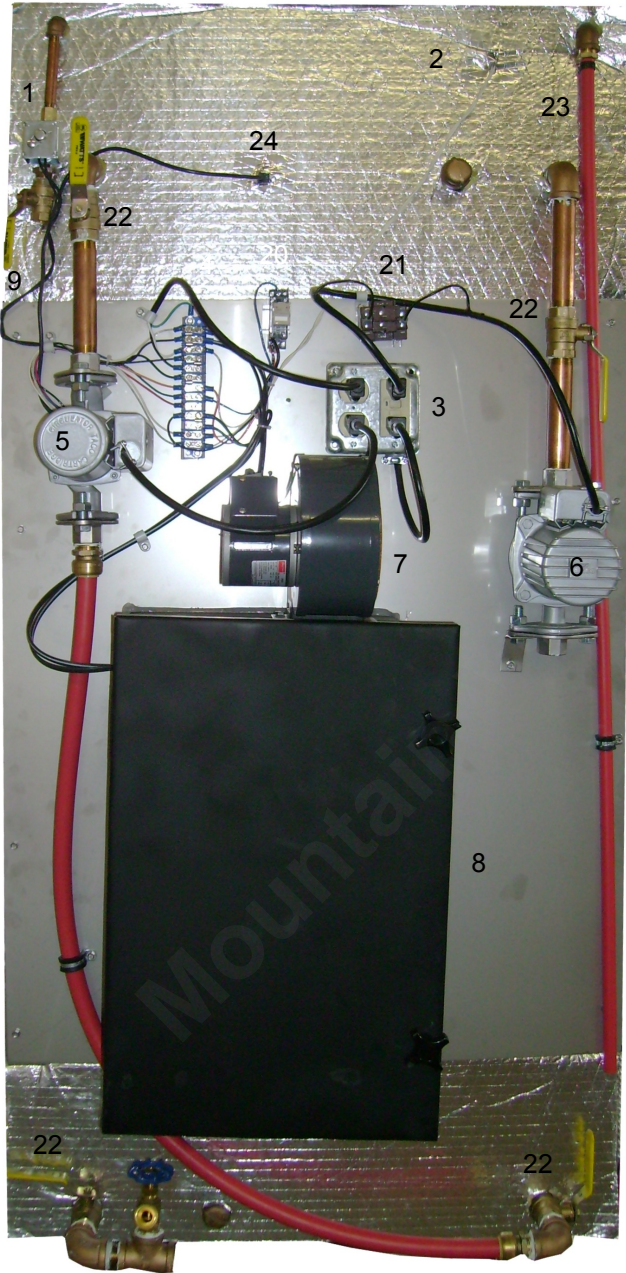

Item	Part No	Description
1	1100.00	Water solenoid valve assembly
2	1100.28	SMD 1/2" Float switch
3	2004.00	Ground fault interrupter receptacle
4	2004.30	Terminal block assembly
5	508.50	Taco 008 SS Circulator
6	502.50	Taco 009 SS Circulator
7	2002.69	1TDR6 Blower
8	7165.45	Air volume box
9	2065.10	Temperature logic controller (not shown)
10	2065.50	Turbulators ( see section 1-2)
11	7165.99	Bypass damper ( see section 1-2)
12	2001.05	Damper solenoid ( see section 1-2)
13	7165.40	Air tube damper assy. ( see section 1-2)
14	3105.18	Secondary air distribution plenum ( see section 1-2)
15	3105.17	Fire grate ( see section 1-2)
16	2165.27	Back wall brick ( see section 1-2)
17	2165.28	Side brick ( see section 1-2)
18	2165.31	Bottom front & back bricks ( see section 1-2)
19	7165.20	Primary air distribution plenum ( see section 1-2)
20	2000.53	Lockout relay
21	2000.52	Honeywell relay
22	607.12	3/4" Ball valve
23	810.00	1/2" Overflow pipe
24	2000.31	Dwyer Thermo Well

Mountain View Hearth Products  
manuals.stove-parts-unlimited.com

THIS PAGE INTENTIONALLY LEFT BLANK

# 25 YEAR LIMITED WARRANTY

Hardy Manufacturing Co., Inc. (HARDY), hereby warrants that HARDY products shall be free from defect in material and workmanship under normal use according to the provisions and limitations herein set forth. HARDY warrants the Fire Box/Water Tank for five (5) years from the date of purchase by the original purchaser and pro rata thereafter according to the following schedule:

- \* If the defect occurs to the tank during the sixth year, customer pays 20% of repair or replacement.
- \* If the defect occurs to the tank during the seventh year, customer pays 35% of repair or replacement.
- \* If the defect occurs to the tank during the eighth year, customer pays 50% of repair or replacement.
- \* If the defect occurs to the tank during ninth year, customer pays 65% of repair or replacement.
- \* If the defect occurs to the tank during the tenth year, customer pays 80% of repair or replacement.
- \* If the defect occurs to the tank during the eleventh through twenty-fifth year, customer pays 85% of repair or replacement.

HARDY warrants catalytic combusters, if standard with furnace, for a period of three (3) years from the date of purchase by the purchaser.

HARDY warrants electrical and plumbing components for a period of one (1) year from date of purchase by the purchaser.

HARDY warrants all other Hardy Manufacturing products for a period of one (1) year from the date of purchase by the purchaser.

## ***Limitations:***

The obligation of HARDY for a breach of warranty shall be limited to products manufactured by HARDY 1) that are installed, operated and maintained according to HARDY's instructions, including Best Burn Practices, furnished and/or available to the purchaser upon request; 2) that are installed according to all other applicable Federal, State and local codes or regulations; and 3) that the purchaser substantiates products were defective in material and workmanship notwithstanding that they were properly installed and correctly maintained as set forth above and were not abused or misused.

The obligation of HARDY shall be limited to repairing or replacing the defective product, at the option of HARDY. HARDY shall not be responsible for any labor or cost removal or reinstallation of its products and shall not be liable for transportation costs to and from its plant in Philadelphia, Mississippi.

Use of parts for modification or repair of the product or any component part thereof not authorized or manufactured by HARDY specifically for such product shall void this warranty. Use of water in water tank that exceeds 45 ppm chloride content shall void warranty. Operation not in accordance with the provided "Installation and Operating Instructions" shall void the warranty.

This warranty shall not apply to any damage to or defect in any of HARDY's products that is directly or indirectly caused by 1) force majeure, Act of God or other accident not related to an inherent product defect, or 2) abuse, misuse or neglect of such product, including any damage caused by improper assembly, installation, adjustment, service, maintenance, or faulty instruction of the purchaser.

Other than as expressly set forth herein above, HARDY makes no other warranty, express or implied, with respect to any of HARDY's products including but not limited to any warranty of merchantability or fitness for a particular purpose.

And in no event shall HARDY be responsible for any incidental or consequential damages of any nature suffered by purchaser or any other person of entity caused in whole or in part by any defect in any HARDY's products. Any person or entity to whom this warranty extends and who claims breach of warranty against HARDY must bring suit thereon within one year from the date of occurrence of such breach of warranty or by forever barred from any and all legal or other remedies for such breach of warranty.

HARDY is not responsible for and hereby disclaims any undertaking, representation or warranty made by any dealer, distributor or other person that is inconsistent with or in any way, more expansive than the provisions of this limited warranty. The return of warranty registration, with chloride test strip, to manufacturer is required to secure warranty validation.

This warranty grants specific legal rights and shall be read in conformity with applicable state laws. In some jurisdictions, the applicable law mandates warranty provisions that provide greater legal rights than those provided for herein. In such case, this limited warranty shall be read to include such mandated provisions and any provision herein that is prohibited or unenforceable in any such jurisdiction shall, as to such jurisdiction, be ineffective to the extent of such prohibition or unenforceable without invalidating the remaining provisions and without affecting the validity or enforceability of such provision in any other jurisdiction(s).

*Effective Date: 1-1-2008 • Revision Date: 2/26/2015*

**All warranty claims are handled through local Hardy Dealers.**

**Contact Hardy Mfg. Co., Inc. at 601-656-5866 to obtain contact information on local Hardy Dealers.**