

**Models:**  
DM1031, DM1036, DM1039, DM1042, DM1242  
DM1736, DM1742, ODVGF-36, ODVGF-42  
**Bi-fold Glass Doors**



These bi-fold glass doors have been tested for use with specific Hearth & Home Technologies fireplaces and are listed as fireplace parts. Refer to the fireplace installation instructions/owner's manual for the correct accessories to be used. Check with your local building code agency before you begin installation to ensure compliance with local codes, including the need for permits and follow-up inspections. If you encounter any problems regarding code approvals, or if you need clarification of any of the instructions contained here, contact your local Hearth & Home Technologies dealer or visit [www.hearthnhome.com](http://www.hearthnhome.com).

**Note:** An arrow (➡) found in the text signifies change in content.

**CAUTION**



**Sharp Edges**

- Wear protective gloves and safety glasses during installation.



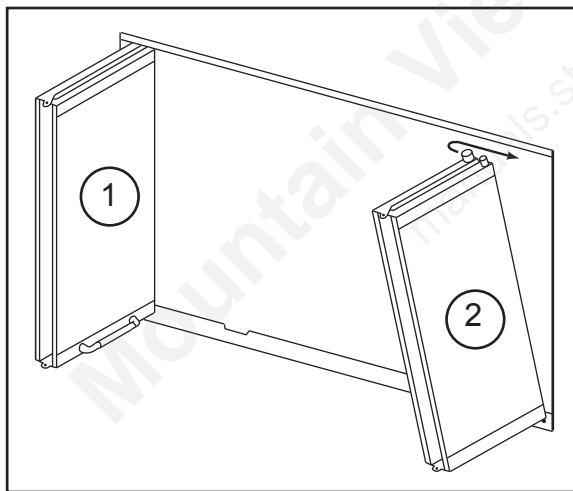

Item #	Description	Qty.
1	LH Bi-fold Door Assy.	1
2	RH Bi-fold Door Assy.	1
	RH Bottom Door Track for ODVGF (See Figure 5)	1
	LH Bottom Door Track for ODVGF (See Figure 6)	1

**Note:** Before burning the fireplace for the first time, wipe the trim with a clean, dry rag to remove all smudges and fingerprints. Failure to do so will cause smudges and fingerprints to be burned into the finish of the trim.

**Note:** An arrow (➡) found in the text signifies change in content.

**⚠ WARNING**



**Fire Risk**

- Close firescreen when burning fireplace.
- Do not use firescreen or glass doors to hold burning material in fireplace.

Firescreen controls sparks.  
Glass may break or burning material may roll out.

**⚠ WARNING**



**Fire Risk**

**Smoke Risk**

- Doors must be fully opened or fully closed when operating fireplace.

Partially opened doors may draw flame, smoke or heat from fireplace.

**Note:** Glass doors aid in the prevention of loss of room heat through an open chimney.

**A. For Use on Reveal Series Appliances**

- Door installation on the RBV4236 or RBV4842 requires longer pins. The longer pins and screws to attach them are located on the valve bracket of the appliance. See Figure 1.

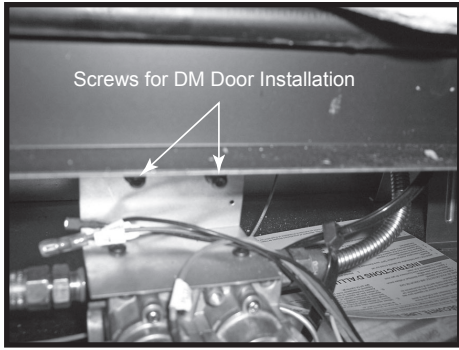

Figure 1 Pins & Screws for DM Door Installation - Reveal

- Remove the shorter door pins using a phillips screwdriver and replace them with the longer pins. See Figure 2.

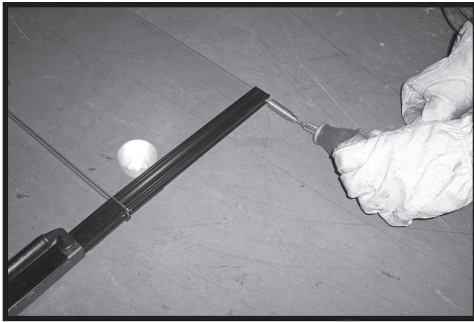

Figure 2 Install Pins

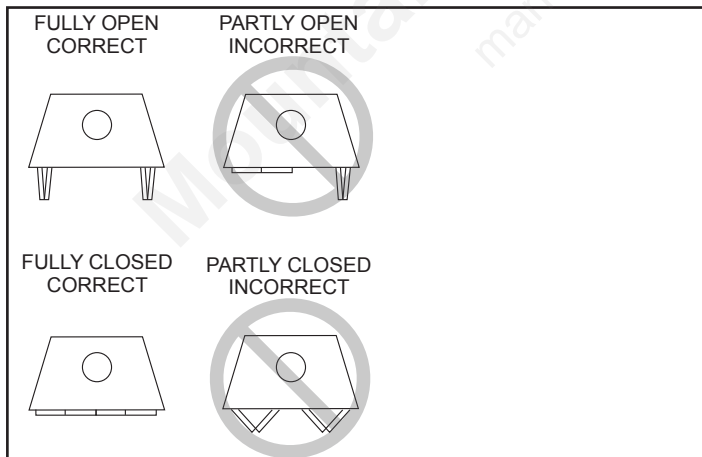

Figure 3 Proper Operation of Bi-fold Glass Doors

**B. For Use on Odvilla-36, Odvilla-42 Outdoor Woodburning Fireplace**

- Remove the four screws on the lower face of the fireplace. See Figure 4. Then install the bottom door track as shown below in Figures 5 and 6 using the four screws that were removed.

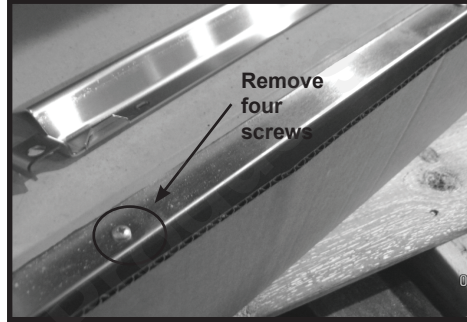
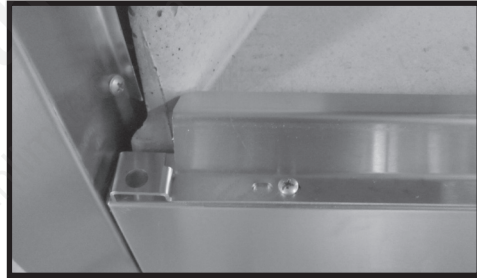

Figure 4



► Figure 5 Left Side Door Track



► Figure 6 Right Side Door Track

**C. For All Installations**

- Fold one pair of doors. Insert the pin into the large hole located at the bottom outside corner of the fireplace opening. Tilt it toward the center of the fireplace such that the pins clear the top door track edge. Slide the pin into the top door track until the pin snaps into the hole in the spring clip. NOTE: The spring clip may need to be bent down more to ensure that the door pin snaps into the hole.
- Doors may be adjusted by repositioning the spring clips in the screw slots, by loosening the screws and then retightening. Do not overtighten the screws!
- If removal becomes necessary, depress the spring clips located in the upper corners of the fireplace and tilt the doors towards the center of the fireplace opening.

Hearth & Home Technologies  
7571 215<sup>th</sup> Street West, Lakeville, MN 55044  
www.hearthnhome.com