

## **PelletVent®**

**Multi-fuel venting system.**

**UL 641, ULC S609, and**

**ULC/ORD C441.**



## Specifications

### Applications

PelletVent for Multi-fuel is a venting system designed for stoves that burn multi-fuels or oil fuel. Multi-fuels include: wood pellets, corn, cherry pits, switch grass, coffee husks, walnut shells, soybeans, wheat, sunflower hulls, rapeseed, and sugar beets. (Rated for continuous use flue temperatures up to 570° F.)

### Materials and Construction

PelletVent for Multi-fuel is a double-wall pipe with an inner wall of .012" super-ferritic stainless steel and a .018" laser-welded galvalume outer wall.

Painted black exterior available.

### Clearances

3" clearance to combustibles in the USA for appliances using wood pellets or oil.  
1" clearance to combustibles in Canada for oil-burning (type L vent) appliances.  
3" clearance to combustibles in Canada for wood pellet-burning appliances.

### Diameters

3" & 4"

### Listings

c-UL-us Listed to UL 641 (MH8381 and MH14420).  
ULC Listed to ULC S609, ULC/ORD C441 (CMH1439 and CMH1440).



## UL 641, ULC S609, and ULC/ORD C441 System

### PelletVent Pro for multi-fuels

PelletVent is a patent-pending venting system for stoves and inserts that use multi-fuels (including wood pellets, corn, cherry pits, switch grass, coffee husks, walnut shells, soybeans, wheat, sunflower hulls, rapeseed, and sugar beets) or oil fuel. As a result of Simpson Dura-Vent's cutting-edge manufacturing process and commitment to innovation, PelletVent is uncompromised in attention to detail and performance.

Select components are available in black to enhance interior aesthetics.

PelletVent is UL listed for 3" clearance to combustibles in the USA and in Canada. Its double-wall, air-insulated design offers superior performance. PelletVent seams are factory-sealed on all elbows, tees, and fittings.

Since the introduction of pellet stoves in the 1980's, Simpson Dura-Vent is recognized as the industry leader in venting systems for pellet stoves. Today, approximately 3 of every 4 pellet stoves in the US and Canada are vented with a Simpson Dura-Vent pellet system.



## Typical Installations

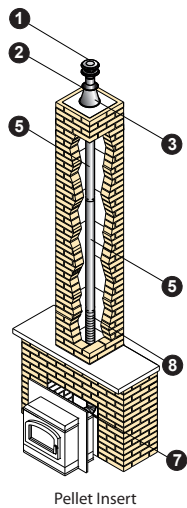

Pellet Insert

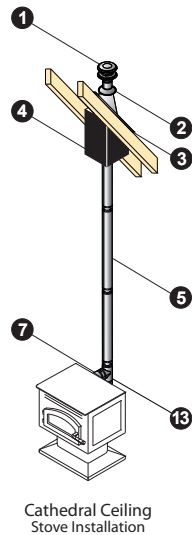

Cathedral Ceiling Stove Installation

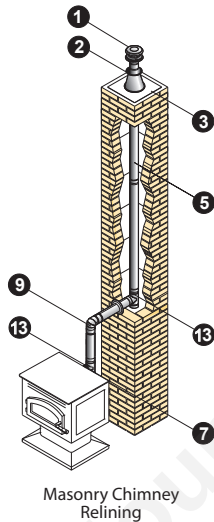

Masonry Chimney Relining

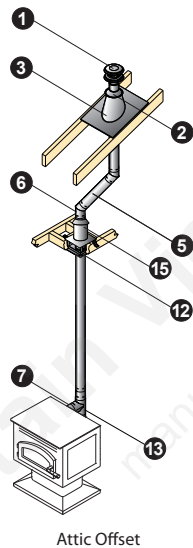

Attic Offset

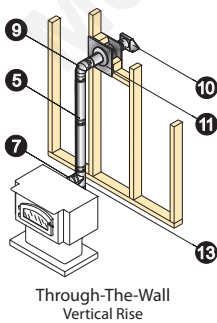

Through-The-Wall Vertical Rise

Installation Key			
1	Vertical Cap	9	90° Elbow
2	Storm Collar	10	Horizontal Cap
3	Flashing	11	Wall Thimble
4	Cathedral Ceiling Support Box	12	Ceiling Support Firestop Spacer
5	Pipe	13	Tee w/Clean-Out Tee Cap
6	45° Elbow	14	Tee Support Bracket
7	Appliance Adapter	15	Attic Insulation Shield
8	60" Flexible Length		

- Refer to our Typical Venting Installation drawings to select the appropriate component parts for your installation.
- The inner pipe diameter should match the outlet size of the appliance. For installations that require 4" vent and the appliance has a 3" outlet, use an Increaser Adapter 3"-4".
- Check the appliance manufacturer's installation instructions to confirm which types of vent configurations are permitted (i.e. horizontal, vertical, chimney reline, etc.). Also, check for any venting restrictions such as maximum horizontal run, minimum and maximum vertical rise, maximum offset, etc.
- Be fire safe! Maintain the minimum clearances (air-space) between the vent pipe and nearby combustibles, as specified in the appliance manufacturer's installation instructions. Use proper support and bracing. Follow local building codes and have your venting system inspected.

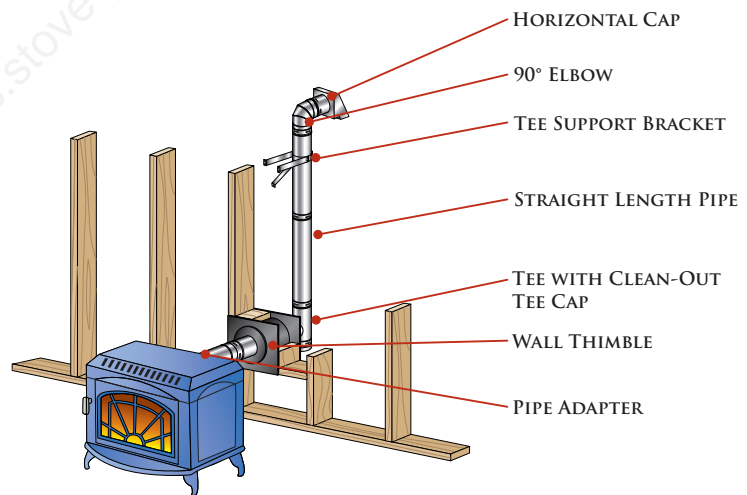

## Planning Your Installation

1	Refer to the Typical PelletVent Installations diagram, on the opposite page, to be familiar with some of the standard PelletVent installations and the required component parts.
2	For a horizontal termination, you will need a Wall Thimble and a Horizontal Cap. The cap must be installed with a 6" clearance to the outside wall (refer to appliance manufacturer's installation instructions for other clearances).
3	For a vertical termination, you will need a Cathedral Ceiling Support Box or Flat Ceiling Support, Attic Insulation Shield (if passing through an attic), Flashing, Storm Collar, and Vertical Cap.
4	Determine the length of PelletVent pipe required. For a vertical termination, measure the pitch of the roof and select the proper flashing. The required minimum height above the roof is 12".
5	Pellet stove inserts in masonry fireplaces will require a flex pipe to snake the vent past the smoke shelf. For transition from PelletVent to an existing DuraPlus, DuraPlus HTC, or DuraTech Chimney, a Chimney Adapter is available.
6	For vertical rise of PelletVent on the outside of the house, Wall Straps should be used at 4' intervals to provide proper support.
7	Important! Check to be sure that the appliance and the venting system are in compliance with all minimum clearance to combustibles requirements.

## Design Recommendations

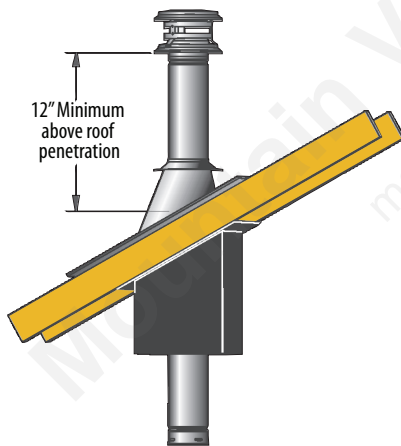

The following design recommendations are intended only as a general guideline to assist in the design and selection of venting components for your installation. Always read and follow Simpson Dura-Vent Installation instructions before installing your chimney system(found with the cap or support box). Installation instructions can be viewed online at [www.duravent.com](http://www.duravent.com), under Catalogs and Instructions.

- Size the vent to meet the appliance manufacturer's specifications.
- Avoid long runs and excessive use of elbows. Refer to the appliance manufacturer for minimum rise and maximum run configurations for the venting system.
- Use an Appliance Adapter to ensure a proper connection to the appliance. Seal adapter to appliance with high temperature sealant.
- Use a Single Tee with Clean-Out Tee Cap to facilitate easy cleaning. It is recommended to use a tee off the back of an appliance.
- In the United States and Canada, maintain the minimum 3" clearance (air space) from vent pipe to combustibles. Use proper support and bracing. Follow local building codes and have your venting system inspected. Be fire safe!

## Horizontal Kit



Kit includes: Square Horizontal Cap, 90° Elbow, Tee Support Bracket, Five 12" Pipe Lengths, Tee with Clean-out, Appliance Adapter, and Wall Thimble. 4" Kit includes a 3"-4" Appliance Adapter/Incraser.

SIZE	STOCK #
3"	33000
4"	33100

## Pipe

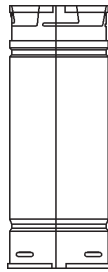

Features fully unitized, twist-lock construction in 3" and 4" diameters. Listed at 3" clearance to combustibles, in the USA. It can be used in both vertical and horizontal installations. Stainless steel wall, combined with a galvanized outer wall. Pipe OD is diameter plus  $\frac{5}{8}$ ". Galvalume or painted black outer finish. 12" length available with stainless steel outer (SS).

SIZE	3"	4"
12"	33012	33112
12" BLACK	33012B	--
24"	33024	33124
36"	33036	33136
36" BLACK	33036B	--
60"	33060	33160
60" BLACK	33060B	--

## Adjustable Pipe

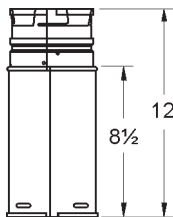

Use to add length to PelletVent pipe. 12" pipe adds 3"-10" of length, when used with rigid sections of pipe. Galvalume or painted black outer finish.

SIZE	STOCK #	A
3"	33012A	12"
3" BLACK	33012AB	12"
4"	33112A	12"

### Flex Pipe



Use when relining masonry chimney. Allows for offsets with pellet-burning appliances. Female and male ends twist-lock. Female end swivels for easy alignment. 60" flex section. Not for use in attic or wall spaces.

SIZE	STOCK #
3"	3060F
4"	3160F

### Appliance Adapter

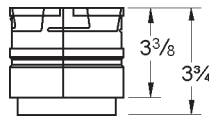

Use to attach to appliance outlet allowing for easy pipe connection. Seal adapter to appliance with high temperature sealant.

SIZE	STOCK #
3"	33079
3" BLACK	33079B
4"	33179

### Appliance Adapter/Increaser

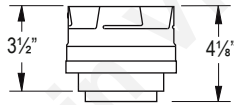

Use to attach to appliance outlet allowing for easy pipe connection. Allows connection of 4" vent to 3" appliance outlet. Seal adapter to appliance with high temperature sealant.

SIZE	STOCK #
3"	33076

### 45° Elbow

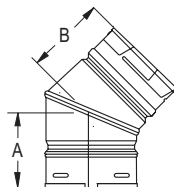

Offsets obstructions as needed. Elbows swivel 360° at base. Angle not adjustable.

SIZE	STOCK #	A	B
3"	33045	3 7/8"	4"
3" BLACK	33045B	3 7/8"	4"
4"	33145	3 7/8"	4"

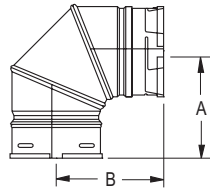
**90° Elbow**

Offsets obstructions as needed. Elbows swivel 360° at base. Angle not adjustable.

SIZE	STOCK #	A	B
3"	33090	5 ½"	5 ½"
3" BLACK	33090B	5 ½"	5 ½"
4"	33190	5 ½"	5 ½"

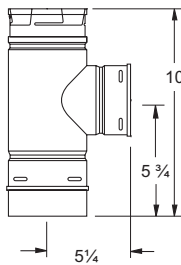
**Single Tee With Clean-Out Tee Cap**

Use for a 90° offset. Branch swivels for alignment. Removeable twist-lock Clean-Out Tee Cap.

SIZE	STOCK #
3"	33067
3" BLACK	33067B
4"	33167

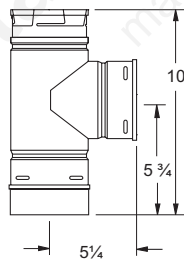
**Increaser Tee With Clean-Out Tee Cap**

Attaches 3" pipe to branch and 4" pipe to body. Use for a 90° offset. Branch swivels for alignment. Removeable twist-lock Clean-Out Tee Cap.

SIZE	STOCK #
4"	33166

### Clean-Out Tee Cap

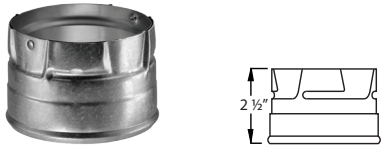

Use as a replacement Clean-Out Tee Cap.

SIZE	STOCK #
3"	33067
3" BLACK	33067B
4"	33167A

### Vertical Cap

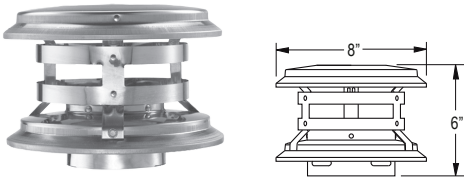

Use for vertical installations only. Required where pipe terminates above the roofline.

SIZE	STOCK #
3"	33080
4"	33180

### Square Horizontal Cap

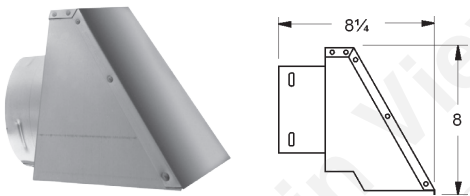

Use for horizontal terminations only. Cap features swivel collar to adjust exhaust direction. Cap features an optional swivel base.

SIZE	STOCK #
3"	33085
4"	33185

### Wall Thimble

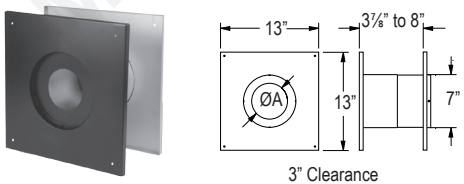

Use to provide required 3" clearance to combustibles. Fits between standard wall studs. Comes with an insulation ring to cut drafts where the pipe slips through the thimble.

SIZE	STOCK #	A
3"	33043	3 3/4"
4"	33143	4 3/4"

### Ceiling Support Firestop Spacer

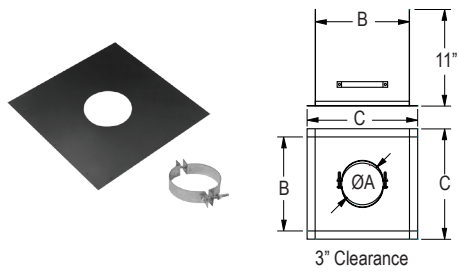

Required where vent passes through ceiling. Centers pipe to provide proper 3" clearance. Support Clamp included. Painted black.

SIZE	STOCK #	A	B	C
3"	3042	3 3/4"	9 5/8"	11 5/8"
4"	3142	4 3/4"	10 5/8"	12 5/8"

### Tee Support Bracket

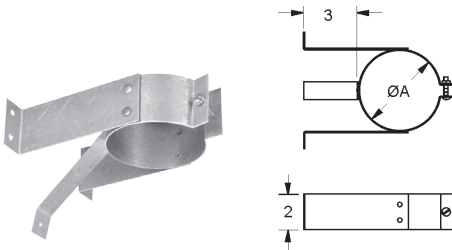

Use to support vent pipe or tee sections. Provides 1" clearance.

SIZE	STOCK #	A
3"	3069	3 5/8"
4"	3169	4 5/8"

### Cathedral Ceiling Support Box

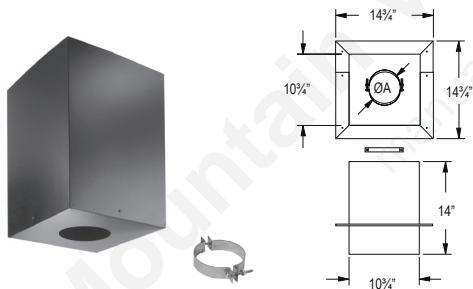

Use to support pipe. May be used on flat ceilings. Painted black. Trim and clamp included.

SIZE	STOCK #	A
3"	3041	3 3/4"
4"	3141	4 3/4"

### Storm Collar

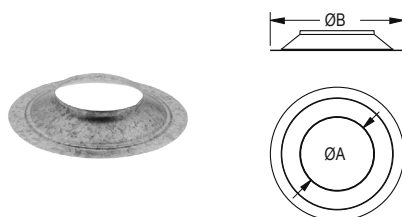

Use to maintain a weather tight resistant seal between the pipe and the flashing. Seal the under side with 500° F silicone sealant to the vent.

SIZE	STOCK #	A	B
3"	3059	3 5/8"	7 3/8"
4"	3159	4 5/8"	8 1/8"

### Attic Insulation Shield

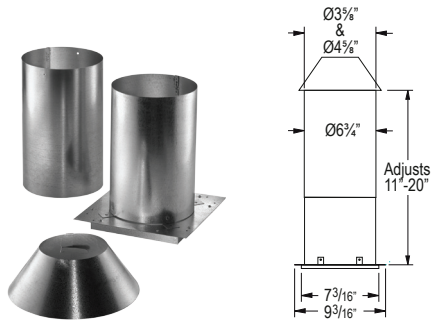

Required for installations that pass through an attic to prevent insulation and debris from accumulating near the vent. Provides 1" clearance to combustibles. Note: In Canada, Attic Insulation Shield does not provide sufficient clearance for use with pellet-burning applications (3" clearance is required in Canada).

SIZE	STOCK #
3"	3054
4"	3154

### Adjustable Roof Flashing

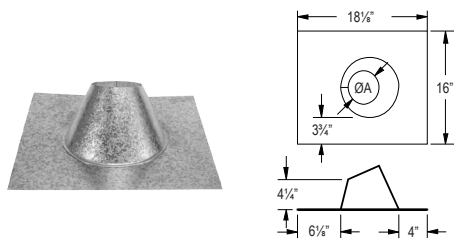

Use to weather proof the penetration of vent pipe through the roof. Storm Collar required. Select roof flashing based on pitch of roof. For pitches of 0/12 - 6/12. For steep roof pitches, refer to the Gas Vent catalog. Made of galvalume.

SIZE	STOCK #	A
3"	3049	3 3/4"
4"	3149	4 3/4"

### Tall Cone Roof Flashing

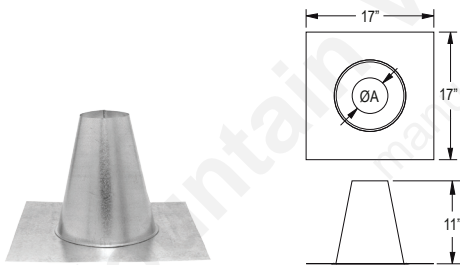

Use to weather proof the penetration of vent pipe through the roof. Storm Collar required. Select roof flashing based on pitch of roof. Use on flat roofs, chase enclosures, or masonry chimney. Made of galvalume.

SIZE	STOCK #	A
3"	3051	3 3/4"
4"	3151	4 3/4"

### Reduction Collar

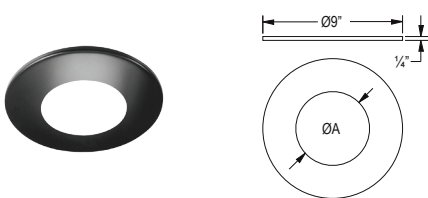

Reduces the center hole diameter in the Ceiling Support /Wall Thimble Cover to fit 3- or 4-inch pipe. Can be used as trim collar when penetrating a masonry chimney with PelletVent. Painted black.

SIZE	STOCK #	A
3"	3957	3 3/4"
4"	3958	4 3/4"

## Increaser

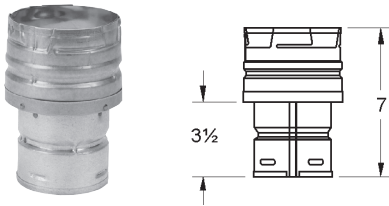

Use to transition from 3" pipe to a 4" pipe. Not a decrease or stove adapter.

SIZE	STOCK #
3" - 4"	33073

## Chimney Adapter

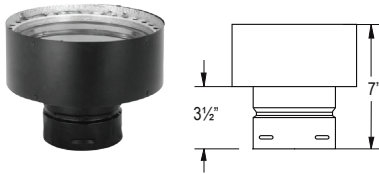

Use to transition between PelletVent to existing chimney such as DuraTech, DuraPlus or DuraPlus HTC. Requires a DVL/DuraBlack Chimney Adapter to fasten into support box or wall thimble, for 6", use adapter 8674, for 8", use adapter 8874.

SIZE	STOCK #
3" - 6"	3074
3" - 8"	3174
4" - 6"	3174
4" - 8"	3175

### Offset Chart

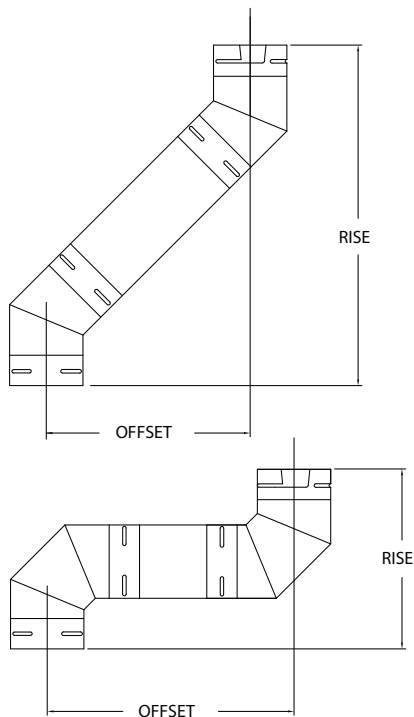

Elbow Angle from Vertical	Chimney Length Between Elbows	Ø3" Offset	Ø3" Rise	Ø4" Offset	Ø4" Rise
45°	0"	4 ¼"	11"	5"	12 ¾"
45°	6"	8"	14 ¾"	8 ⅝"	16 ⅜"
45°	12"	12 ¼"	19"	13 ½"	21 ⅛"
45°	24"	20 ¾"	27 ¾"	21 ⅞"	29 ⅝"
45°	36"	29 ¼"	36"	30 ⅜"	38 ⅛"
45°	24" + 24"	36 ⅝"	43 ¾"	37 ¾"	45 ½"
45°	60"	46 ⅞"	52 ⅞"	46 ¾"	54 ½"
45°	36" + 36"	53 ½"	60 ¾"	54 ¼"	62"
90°	0"	9 ⅞"	10 ¾"	10 ⅝"	11 ⅜"
90°	6"	14 ⅞"	10 ¾"	15 ⅞"	11 ⅜"
90°	12"	20 ⅞"	10 ¾"	21 ⅞"	11 ⅜"
90°	24"	32 ⅞"	10 ¾"	33 ⅞"	11 ⅜"
90°	36"	44 ⅞"	10 ¾"	45 ⅞"	11 ⅜"
90°	24" + 24"	54 ⅞"	10 ¾"	55 ⅞"	11 ⅜"
90°	60"	68 ⅞"	10 ¾"	69 ⅞"	11 ⅜"
90°	36" + 36"	78 ⅞"	10 ¾"	79 ⅞"	11 ⅜"