

## NEWMAC COMBINATION FURNACES AND WOOD BURNING STOVES

[www.newmacfurnaces.com](http://www.newmacfurnaces.com)

### INDEX

COMBINATION OIL/SOLID FUEL BOILER	
MODEL BC-160-095/170 .....	2-7 – 2-8
INTRODUCTION .....	2-2
WOOD AND OIL/GAS COMBINATION	
MODELS CL-86-96C CL-115-170C .....	2-2 – 2-3
WOOD AND WOOD/COAL ADD-ONS	
MODELS WAO (WOOD) AND GAO (WOOD/COAL) .....	2-4
WOOD STOVES .....	2-10
NC 100 CLASSIC I .....	2-14
NCM 120 CLASSIC II .....	2-13
NS 220 .....	2-15
WOOD STOVES — EPA CERTIFIED .....	
NC-100E CLASSIC I EPA .....	2-11
NCM-120E CLASSIC II EPA .....	2-11
NS-220E STATUS EPA .....	2-12
WOOD/WOOD-COAL FURNACES	
MODELS WB-100 AND WG-100 .....	2-5 – 2-6
WOOD/COAL/ELECTRIC COMBINATION	
MODELS WB-100E AND WG-100E .....	2-9

*This section contains product and technical information only.*  
For additional information and product pricing please contact your local ECCO Supply Sales Branch.

ECCO is proud to be a member of:



# NEWMAC COMBINATION FURNACES AND WOOD BURNING STOVES

www.newmacfurnaces.com

## INTRODUCTION

### Proven Comfort — Newmac — Alternative Fuels, High Efficiency Heating Tools

Over the past twenty-five years Newmac has gained a reputation for developing the kind of high efficiency furnaces and boilers that their customers demand. Their multi-fired units are competitively priced and built under strict ISO 9001 standards to ensure years of dependability. All units are backed by the best warranties in the business and Newmac offers technical support that you can count on.

## WOOD AND OIL/GAS COMBINATION

### MODELS CL-86-96C / CL-115-170C

Separate combustion chambers with automatic switching from wood to oil, separate thermostats, and a large fire-door begin a list of conservation features. This furnace burns wood without grates for better control and efficiency.

- **CL-86-96-C** – Output 86,000-96,000 BTUs
- **CL-115-170C** – Output 115,000-170,000 BTUs

**NOTE:** Select model based on heat loss of home.

### Features

- 1 Separate combustion chamber for oil/gas
- 2 All welded steel heat exchanger with a 10 year limited pro-rated warranty
- 3 Steel inner wall gives extra insulating protection
- 4 Wide flue passages for easy cleanout
- 5 Secondary heat exchanger maximizes heat transfer
- 6 Ceramic fibre chamber for combustion efficiency
- 7 Extra large brick lined firebox
- 8 Quiet flame retention head oil burner or power gas burner
- 9 Optional heavy duty cast iron shaker grates facilitate burning coal or wood with a large cleanout door
- 10 Preheated combustion air is introduced by a thermostatically controlled draft system. This method promotes high efficiency and reduces creosote
- 11 A curtain of air prevents smoke from coming out the firedoor when the furnace is charged with fuel
- 12 Disposable air filters
- 13 Extra large firebox door for easy loading
- 14 Twin blowers

**NOTE:** All solid fuel and combination furnaces will provide gravity heat during a power failure when installed correctly.

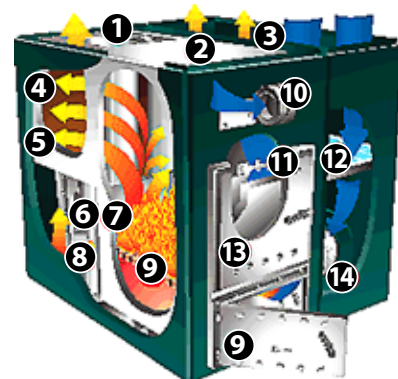

# NEWMAC COMBINATION FURNACES AND WOOD BURNING STOVES

[www.newmacfurnaces.com](http://www.newmacfurnaces.com)

## WOOD AND OIL/GAS COMBINATION (cont'd)

### MODELS CL-86-96C CL-115-170C (cont'd)

#### Dimensions

MODEL	CL-86C	CL-96C	CL-115C	CL-140C	CL-155C	CL-170C
BTUH OUTPUT	86,000	96,000	111,000	140,000	152,000	169,000
NOZZLE GPH	.75	.85	1.00	1.25	1.35	1.50
(80° SOLID)	(80°)R	(80°)R	(80°)R	(80°)R	(80°)R	(80°)R
BLOWER	TWAIN 9"	TWAIN 9"	TWAIN 10"	TWAIN 10"	TWAIN 10"	TWAIN 10"
MOTOR	1/3 HP	1/3 HP	1/3 HP	1/3 HP	1/3 HP	1/3 HP
CFM	1200	1200	1300	1500	1700	1900
AIR FILTERS	2-16" × 25"	2-16" × 25"	2-20" × 25"	2-20" × 25"	2-20" × 25"	2-20" × 25"
EX STATIC	.20	.20	.20	.20	.20	.25
FLUE (")	8	8	8	8	8	8
FIREBOX – INSIDE DIMENSIONS (")	24 × 14 × 18	24 × 14 × 18	22-1/2 × 18 × 18	22-1/2 × 18 × 18	22-1/2 × 18 × 18	22-1/2 × 18 × 18
(L-W-H)	(Firebrick)	(Firebrick)	(Firebrick)	(Firebrick)	(Firebrick)	(Firebrick)
FIREDOOR (")	14 × 14	14 × 14	17-1/2 × 17-1/2	17-1/2 × 17-1/2	17-1/2 × 17-1/2	17-1/2 × 17-1/2
CLEAN OUT DOOR	N/A	N/A	N/A	N/A	N/A	N/A
WEIGHT (LBS)	680	680	1035	1035	1035	1035
ELECTRICS	-	-	-	-	-	-

#### Dimensions

MODEL	CL-86C-96C	CL-115C-170C
A LENGTH (")	49-1/4	53-1/2
B WIDTH (")	42	48-1/4
C HEIGHT (")	45-1/2	51-1/2
D & F RETURN AIR PLENUM (")	16-1/4 × 47-1/2	18-1/4 × 51-1/2
E & F WARM AIR PLENUM (")	22-1/4 × 47-1/2	26-1/4 × 51-1/2
G BLOWER SECTION WIDTH (")	18	20
H FURNACE SECTION WIDTH (")	24	28-1/4
J FLUE PIPE DIAMETER (")	8	8
K FLUE PIPE TO SIDE OF FURNACE (")	12	14
L FLOOR TO CENTRE OF FLUE PIPE (")	33-1/2	35

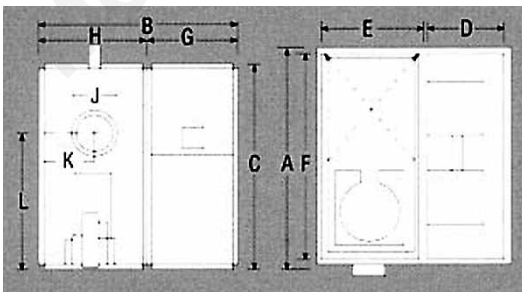

CL-86-96C, CL-115C-170C

- E.&amp;O.E. - All Prices F.O.B. Our Warehouse - Subject to Change Without Notice - All Taxes Extra -

# NEWMAC COMBINATION FURNACES AND WOOD BURNING STOVES

www.newmacfurnaces.com

## WOOD AND WOOD/COAL ADD-ONS

### MODELS WAO (WOOD) AND GAO (WOOD/COAL)

Newmac's WAO-wood and the GAO / Coal solid fuel Add-On furnaces are designed for operation in conjunction with existing residential oil furnace systems.

Both furnaces provide increased heating efficiency without the expense of an all new retrofit installation. The Newmac WAO-Wood and GAO Coal furnaces have a performance range of 80,000 – 100,000 BTUs. They are WARNOCK-HERSEY listed as an add-on for use with an oil-fired system which has a firing rate of .75 gph to 1.10 gph. Tested to CSA Standard 336.1M and UL Standard 391.

#### Features

- Extra large firedoor for easy charging and cleaning
- Firebrick-lined 24" firebox
- Thermostatically controlled draft system forces preheated air into the combustion chamber for high efficiency and minimal creosote buildup
- Heat-exchanger, 14 gauge all welded steel for durability
- Newmac 10 year limited warranty
- Cast iron shaker grates on GAO model

#### Specifications

MODEL	WAO	GAO
BTUH OUTPUT	100,000	100,000
CFM	1200	1200
EX STATIC	0.20	0.20
FLUE (")	8	8
FIREBOX – INSIDE DIM. (L-W-H) (")	24 x 14 x 18	24 x 14 x 18
FIREDOOR	14 x 14	14 x 14
CLEAN OUT DOOR	N/A	9 x 14
WEIGHT (LBS)	425	580

#### Dimensions

MODEL	WAO	GAO
A LENGTH (")	31-1/4	31-1/4
B WIDTH (")	26	26
C HEIGHT (")	45-3/4	45-3/4
D & E RETURN AIR PLENUM (")	–	–
E & P RETURN AIR PLENUM (")	14 x 16-1/8	14 x 16-1/8
D & F WARM AIR PLENUM (")	29-1/2 x 24-1/4	29-1/2 x 24-1/4
G FLUE PIPE DIAMETER (")	8	8
H FLUE PIPE TO CENTRE OF FURNACE (")	–	–
J FLOOR TO CENTRE OF FLUE PIPE (")	38	38
K FLOOR TO BOTTOM OF RETURN AIR (")	2	2
M ELECTRIC INSERT WIDTH	–	–
N PLENUM FOR INSERT	–	–



WAO



GAO

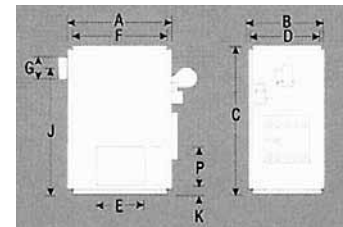

WAO – Wood Add-on

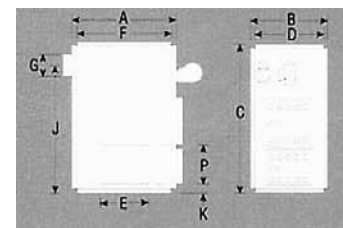

GAO – Grated Add-on

– E.&O.E. – All Prices F.O.B. Our Warehouse – Subject to Change Without Notice – All Taxes Extra –

# NEWMAC COMBINATION FURNACES AND WOOD BURNING STOVES

www.newmacfurnaces.com

## WOOD/WOOD-COAL FURNACES

### MODEL WG-100\*

An extra large firedoor, firebox with shaker grates, and cleanout door are just three of the many features that make the model WG-100 an exceptional solid fuel furnace. This furnace can be used in areas where you have the option of burning readily available energy sources or coal. (80,000-100,000 BTUs)



WG-100

### MODEL WB-100\*

When your solid fuel source is wood only, this grateless furnace offers better control, outstanding performance, reliability and efficiency. This furnace can be used alone or in conjunction with your present system to warm your home, no matter what the weather. (80,000-100,000 BTUs).



WB-100

\*WG or WB not to be used as add-on models. Grated models not recommended for burning wood.

### Features

- 1 Replaceable stack assembly
- 2 Stack Baffle
- 3 Ten year pro-rated warranty on heat exchanger
- 4 Steel inner wall gives extra insulating protection
- 5 Disposable filters
- 6 Large 12" squirrel cage blower moves the filtered air quietly throughout your home
- 7 Scandinavian baffle causes the flame to pass through itself, mixing with secondary air to burn creosote-causing gases
- 8 20" long firebrick lined firebox
- 9 Preheated combustion air is introduced by a thermostatically controlled draft system. This method promotes high efficiency and reduces creosote
- 10 A curtain of air prevents smoke from coming out the firedoor when the furnace is charged with fuel
- 11 Large firedoor for easy loading
- 12 Attractive baked enamel casing



**NOTE:** Cleaning tools provided.

### Specifications

MODEL	WB-100	WG-100
BTUH OUTPUT	100,000	100,000
BLOWER	G 12"	G 12"
MOTOR	1/2 HP	1/2 HP
CFM	1200	1200
AIR FILTERS	2-12" x 24"	2-12" x 24"
EX STATIC	0.20	0.20
FLUE (")	8	8
FIREBOX – INSIDE DIM. (L-W-H) (")	20 x 18 x 13-1/2 (Firebrick)	24 x 14 x 14 (Firebrick)
FIREDOOR (")	14 x 14	14 x 14
CLEAN OUT DOOR (")	N/A	9 x 14
WEIGHT (LBS)	600	650
ELECTRICS	10, 15, 20 or 25 kW	10, 15, 20 or 25 kW

– E.&O.E. – All Prices F.O.B. Our Warehouse – Subject to Change Without Notice – All Taxes Extra –

## NEWMAC COMBINATION FURNACES AND WOOD BURNING STOVES

www.newmacfurnaces.com

### WOOD/WOOD-COAL FURNACES (cont'd)

#### MODEL WB-100 AND WG-100 (cont'd)

##### Dimensions

MODEL	WB100-E	WG100-E
A LENGTH (")	54-1/4	57-1/4
B WIDTH (")	26	26
C HEIGHT (")	43	46
D & E RETURN AIR PLENUM (")	24-1/4 × 23-1/4	24-1/4 × 23-1/4
E & P RETURN AIR PLENUM (")	-	-
D & F WARM AIR PLENUM (")	24-1/4 × 30-5/8	24-1/4 × 23-1/4
G FLUE PIPE DIAMETER (")	8	8
H FLUE PIPE TO CENTRE OF FURNACE (")	13	13
J FLOOR TO CENTRE OF FLUE PIPE (")	33-1/2	37-1/2
K FLOOR TO BOTTOM OF RETURN AIR (")	-	-
L ELECTRIC INSERT HEIGHT (")	16	16
M ELECTRIC INSERT WIDTH (")	30	30
N PLENUM FOR INSERT (")	31 × 18	31 × 18
ELECTRIC INSERT SHIPPING WEIGHT	80 lbs	80 lbs

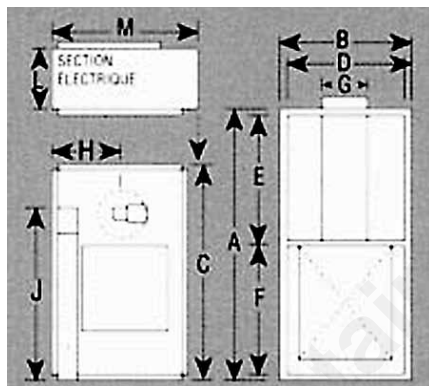

WB100-E/WG100-E

- E.&O.E. - All Prices F.O.B. Our Warehouse - Subject to Change Without Notice - All Taxes Extra -

# NEWMAC COMBINATION FURNACES AND WOOD BURNING STOVES

www.newmacfurnaces.com

## COMBINATION OIL/SOLID FUEL BOILER

### MODEL BC-160-095/170

#### Standard Features

- 1 The horizontal tube construction gives maximum heat transfer and easy access for cleaning
- 2 Extra large doors for easy loading and cleaning
- 3 Wet leg and wet back design provides optimum heat transfer surface area
- 4 A controlled draft system provides greater efficiency by preheating combustion air for improved wood firing
- 5 Extra large 24" firebox
- 6 Cast iron baffles separates wood from oil flue gases for optimum efficiency
- 7 Large 65 gallon water volume insures maximum storage capacity
- 8 A complete pre-wired control package is standard equipment for easy installation
- 9 3 gpm domestic hot water coil

#### Optional Features

- A Cast iron shaker grates for coal burning
- B A quiet flame retention head oil burner firing from 99,000 to 170,000 btu/h
- C Separate stainless steel smoke box with ceramic fiber combustion chamber for oil or gas\*

\*Gas available only in the USA

#### A New Exclusive Feature

The Newmac exclusive central control panel features the ultimate in ease of electrical hook-up.



The installer simply follows a step by step numbered terminal block in the central control panel.

The standard equipment control package includes:

- 2 – L4063B1007 Aquastat
- 1 – L6007A1029 Aquastat
- 1 – 1156F Filler Valve
- 1 – 174A – M3 Relief Valve
- 1 – Tridicator
- 1 – V8043D1080 N.O. Valve

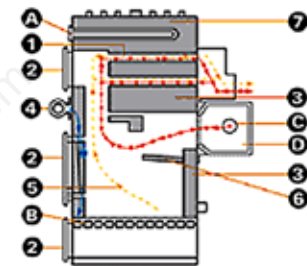
**NOTE:** Numbers may vary according to manufacturer.



-  Pre-heated combustion air
-  Flue gas from oil combustion
-  Flue gas from wood combustion



# NEWMAC COMBINATION FURNACES AND WOOD BURNING STOVES

[www.newmacfurnaces.com](http://www.newmacfurnaces.com)

## COMBINATION OIL/SOLID FUEL BOILER (cont'd)

### MODEL BC-160-095/170 (cont'd)

#### Specifications

MODEL	BC 160	BC 160	BC 160-O95	BC 160-O-115	BC 160-O-140	BC 160-O-155	BC 160-O-170
FUEL	Wood	Wood	Wood/Oil	Wood/Oil	Wood/Oil	Wood/Oil	Wood/Oil
AVG. WOOD	160,000	160,000	160,000	160,000	160,000	160,000	160,000
OIL OUTPUT	N/A	N/A	99,000	115,000	143,000	154,000	170,000
NOZZLE (80R)	N/A	N/A	0.85	1	1.25	1.35	1.5
FLUE DIAMETER (")	8	8	8	8	8	8	8
FIREBOX (L-W-H) (")	24 × 18 × 17	24 × 18 × 17	24 × 18 × 17	24 × 18 × 17	24 × 18 × 17	24 × 18 × 17	24 × 18 × 17
FIREDOOR	14 × 14	14 × 14	14 × 14	14 × 14	14 × 14	14 × 14	14 × 14
CLEAN OUT DOOR	8-1/2 × 14	8-1/2 × 14	8-1/2 × 14	8-1/2 × 14	8-1/2 × 14	8-1/2 × 14	8-1/2 × 14
ASHPIT DOOR	19 × 10-1/2	19 × 10-1/2	19 × 10-1/2	19 × 10-1/2	19 × 10-1/2	19 × 10-1/2	19 × 10-1/2
WEIGHT (LBS)	970	970	1060	1060	1060	1060	1060

#### Dimensions

A	WIDTH (")	27
B	DEPTH (")	30-1/2
C	HEIGHT (")	59
D	TOP TO CENTRE OF CLEANOUT DOOR (")	12
E	CENTRE OF CLEANOUT DOOR TO ASHPIT (")	36
F	HEIGHT OF ASHPIT (")	11
G	DEPTH OF SMOKEBOX	10-1/4
H	FLUE PIPE DIAMETER (")	8
I	DEPTH OF COMBUSTION CHAMBER	14-3/4
J	FLOOR TO CENTRE OF FLUE PIPE	44
K	OVERALL DEPTH INCLUDING INSTALLED OIL SECTION	52
L	NPT MULTIPLE TAPPINGS	3/4
M	NPT SUPPLY TAPPING	2
N	NPT RETURN TAPPING	2

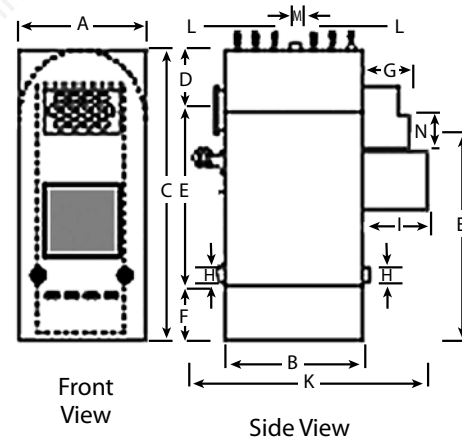

- E.&amp;O.E. - All Prices F.O.B. Our Warehouse - Subject to Change Without Notice - All Taxes Extra -

# NEWMAC COMBINATION FURNACES AND WOOD BURNING STOVES

www.newmacfurnaces.com

## WOOD/COAL/ELECTRIC COMBINATION

### MODELS WB-100E / WG-100E

Newmac models WB-100E and WG-100E provide dependable heat from either solid fuel or electric energy.

#### Solid Fuel Features

- All welded steel construction
- 10 year limited warranty on heat exchanger
- Large firebox and clean-out doors for easy loading and cleaning
- No smoke baffles make wood/coal charging easy and safe
- A curtain of air prevents smoke coming out the firedoor when the furnace is charged with fuel
- Cast iron shaker grates on WG-100E model

#### Electric Features

- Separate thermostats allow automatic switching from solid fuel to electric heat
- Elements designed to sequence on individually and simultaneously with the circulating blower
- No manual resets are necessary. In case of power overload or failure, the unit will automatically come on when power is restored and the electric thermostat is calling for heat
- The electric heating section can be installed to facilitate controls on either side and is CSA certified
- The 10kW unit requires only a standard 100 amp service



WB-100E



WG-100E

#### Dimensions

MODEL	WB100-E	WG100-E
A LENGTH (")	54-1/4	57-1/4
B WIDTH (")	26	26
C HEIGHT (")	43	46
D & E RETURN AIR PLENUM (")	24-1/4 x 23-1/4	24-1/4 x 23-1/4
E & P RETURN AIR PLENUM (")	-	-
D & F WARM AIR PLENUM (")	24-1/4 x 27-1/4	24-1/4 x 30-5/8
G FLUE PIPE DIAMETER (")	8	8
H FLUE PIPE TO CENTRE OF FURNACE (")	13	13
J FLOOR TO CENTRE OF FLUE PIPE (")	33-1/2	37-1/2
K FLOOR TO BOTTOM OF RETURN AIR (")	-	-
L ELECTRIC INSERT HEIGHT (")	16	16
M ELECTRIC INSERT WIDTH (")	30	30
N PLENUM FOR INSERT (")	31 x 18	31 x 18
ELECTRIC INSERT SHIPPING WEIGHT	80 lbs	80 lbs

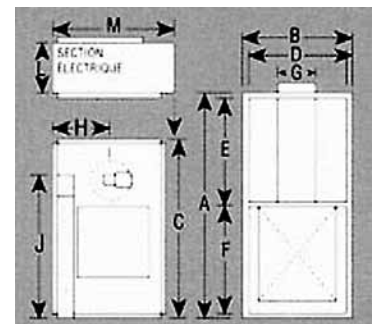

WB100/WB-100E

-E.&O.E. - All Prices F.O.B. Our Warehouse - Subject to Change Without Notice - All Taxes Extra -

## NEWMAC COMBINATION FURNACES AND WOOD BURNING STOVES

www.newmacfurnaces.com

### WOOD STOVES — EPA CERTIFIED

CLEAN, EFFICIENT HEAT. LESS WOOD. LESS EMISSIONS. Built to the same tough standards as all of their products, Newmac EPA certified/CSA B415 compliant wood stoves produce considerably less emissions and provide greater heat output and fuel efficiency overall. Ideal for homes and cottages, Newmac EPA wood stoves create less impact on the environment – and less impact on your heating budget.

#### Newmac – Providing Clean, High Efficiency Heating Solutions Since 1978

Newmac is a Canadian company with its home in Debert, Nova Scotia. Over the past thirty years they have gained a reputation for manufacturing high efficiency furnaces, boilers and wood stoves. All of their products are designed to provide reliable heat and comfort in the most demanding climates and conditions. Engineered for efficiency and built under strict ISO 9001 standards, Newmac products are backed by the best warranties in the business. Competitively priced and a pleasure to own and operate, the comfort of these EPA certified wood stoves can be enjoyed for years to come.



Complies with CSA B415

#### Designing for a Cleaner Environment

CSA B415 Compliant

At a time when more people are turning to the benefits of wood heat, there is also growing concern and awareness for the environment. To meet the changing needs of their customers and reduce environmental impact, Newmac has redesigned their most popular wood stoves to achieve U.S. Environmental Protection Agency (EPA) certification. Their EPA wood stoves comply with the latest Canadian environmental CSA B415 requirements and meet the highest standards for emissions, heat output and overall efficiency. Some of the benefits of Newmac EPA wood stoves include:

- Soothing, radiant heat
- Substantially less smoke
- Dramatically reduced emissions
- Consistent heat even in power outages
- Savings with fuel, time and maintenance

#### A New Generation of Newmac Wood Stoves

Newmac EPA wood stoves include all of the features and benefits their customers have come to expect. Based on tried and true designs, the new models have been adapted to meet the high efficiency and emission standards necessary to achieve EPA certification. Whether you choose from the Classic Series or Status, all EPA models include:

- Automatic thermostat control for even room temperature
- Adjustable Primary Air Control (P.A.C.) for controlled burn rate
- Optional settings for Secondary Air Timer (S.A.T.) to extend heat cycle
- Steel firebox with firebrick lining for improved combustion
- Potential of using up to 1/3 less wood than conventional stoves
- Lift tops for cooking convenience on models NS-220E and NC-100E

– E.&O.E. – All Prices F.O.B. Our Warehouse – Subject to Change Without Notice – All Taxes Extra –

# NEWMAC COMBINATION FURNACES AND WOOD BURNING STOVES

www.newmacfurnaces.com

## WOOD STOVES — EPA CERTIFIED (cont'd)

The Newmac Classic EPA Series offers a wide range of advantages over conventional wood stoves. The main difference between the Classic I and II is the positioning of the flue. The Classic II features a top-mounted flue making it ideal for mobile homes with minimum clearance. The Classic I with its rear-mounted flue has a hinged top that can be lifted for cooking. Both stoves feature:

- Large capacity firebox takes 24" (610 mm) logs with a refueling cycle of up to 10 hours
- Baked enamel finish with decorative screen
- Large removeable ash pan for convenient clean-up
- Optional blower fan with thermostatic heat sensor ensures increased heat circulation throughout the room. Air is distributed at floor level for added comfort
- Provisions to connect outside combustion air



NC-100E Classic I EPA



NCM-120E Classic II EPA

\*Flue pipe added for demonstration purposes.

### NC-100E CLASSIC I EPA

This model heats up to 1200 square feet with an output up to 60,000 btu/h and a rear-mounted flue.

### NCM-120E CLASSIC II EPA

The NCM-120E heats up to 1200 square feet with an output up to 60,000 btu/h and a top-mounted flue.

### Specifications

CABINET	NC-100E CLASSIC I EPA	NCM-120E CLASSIC II EPA
High (")	33	33
Deep (")	20.5	20.5
Wide (")	32	32
<b>FIREBOX</b>		
Wide (")	11.5	11.5
High (")	19	19
Long (")	25.5	25.5
<b>WEIGHT (LBS)</b>	225	225
<b>FAN (optional)</b>	120 volts	120 volts

Lift top for cooking convenience on NC-100E



### Features



Thermostat Control



Adjustable burn rate P.A.C.



Secondary air timer



Outside Air Connection

### Options



Circulation blower



Glass door

### Clearances to Combustibles — Residential and Mobile Homes

<b>SIDE WALL (")</b>	18	10
<b>REAR WALL (")</b>	Min 21	14
<b>FIREDOOR (")</b>	36	36
<b>CORNER (")</b>	12 N/A (mobile homes)	12 N/A (mobile homes)
<b>FRONT (")</b>	48	48
<b>ABOVE (")</b>	51	51
<b>FLUE PIPE (")</b>	18	18

### Clearances to Combustibles With a Reduced Chimney Connector — Residential and Mobile Homes

<b>REAR WALL (")</b>	9	8
----------------------	---	---

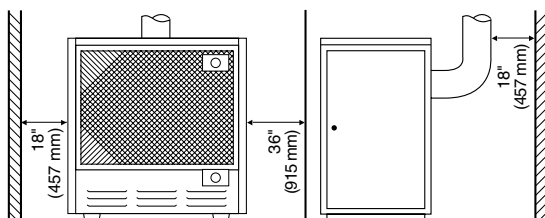

NC-100E Classic I EPA

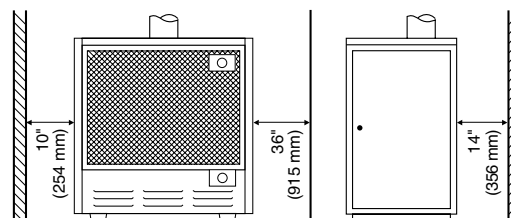

NCM-120E Classic II EPA

— E.&O.E. — All Prices F.O.B. Our Warehouse — Subject to Change Without Notice — All Taxes Extra —

# NEWMAC COMBINATION FURNACES AND WOOD BURNING STOVES

www.newmacfurnaces.com

## WOOD STOVES — EPA CERTIFIED (cont'd)

### NS-220E STATUS EPA

The Newmac NS-220E Status EPA heats up to 1200 square feet and features a traditional front-loading, large capacity firebox.

- Output of up to 60,000 btu/h
- Takes logs up to 20" (508 mm)
- Refueling cycle up to 10 hours
- High heat resistant black cabinet
- Louvered top directs warm air forward and to the sides
- Louvered top directs warm air forward and to the sides
- Lift top for cooking convenience
- Optional glass door available



Optional glass door / Standard door

### Specifications

CABINET	
High (")	30
Deep (")	29
Wide (")	19
FIREBOX	
Wide (")	15
High (")	22
Long (")	22
<b>SHIPPING WEIGHT (LBS)</b>	220
<b>HEIGHT OF LINER (")</b>	12

### Clearances to Combustibles — Residential and Mobile Homes

<b>SIDE WALL (")</b>	24
<b>REAR WALL (")</b>	14.5
<b>CORNER (")</b>	12
<b>FRONT (")</b>	48
<b>FLUE PIPE (")</b>	18

### Clearances to Combustibles With a Reduced Chimney Connector — Residential and Mobile Homes

<b>REAR WALL (")</b>	9
<b>EMISSION RATE</b>	5.0g/hr

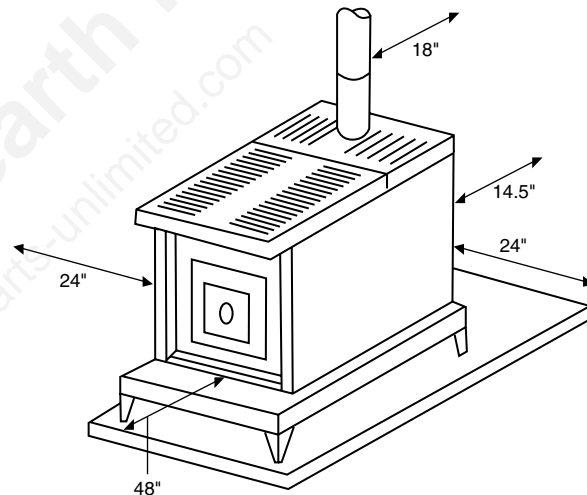

# NEWMAC COMBINATION FURNACES AND WOOD BURNING STOVES

## WOOD STOVES

### NCM 120 CLASSIC II

#### For Residential or Mobile Home Installation

The NCM-120 (Newmac Mobile Classic) with its attractive louvered front lower panel, is as charming in appearance as it is heat efficient. Best of all, the NCM-120 is designed to be safely installed close to combustible walls.



- Built in plate steel baffle system to assure improved secondary combustion resulting in higher efficiency and heating output
- Automatic non-electric control that keeps room temperature constant
- Maximum 55,000-60,000 btuh output – heats 1,200 square ft.
- Combustion is thermostatically controlled
- Optional outside air intake for combustion and mobile home application
- Minimum clearance from combustible wall 7"
- Heavy duty steel firebox with firebrick lining for improved combustion
- Airtight construction for overnight burning, reduced wood consumption and lower heating costs
- Large capacity firebox takes 24" logs with a refueling cycle of up to 10 hours
- The baked enamel finish with decorative screen adds to the charm of any room
- Large removable ash pan for convenient clean-up
- Optional fan with thermostatic heat sensor ensures increased heat circulation throughout the room. Air is distributed at floor level for extra comfort.
- 6" top flue outlet
- Heavy duty cast iron grates

#### Specifications

<b>CABINET</b>	
High (")	33
Deep (")	20.5
Wide (")	32
<b>FIREBOX</b>	
Wide (")	11.5
High (")	19
Long (")	25.5
<b>SHIPPING WEIGHT (LBS)</b>	225
<b>OPTIONAL FAN SYSTEM</b>	120V

# NEWMAC COMBINATION FURNACES AND WOOD BURNING STOVES

www.newmacfurnaces.com

## WOOD STOVES (cont'd)

### NC 100 CLASSIC I

#### For Home or Cottage Installation

Controlled Draft gives the comfort and enjoyment of economical wood heating.

- Automatic non-electric combustion control
- Heats up to five average rooms (50,000 btu/h)
- Large capacity firebox takes 24" logs with a refueling cycle of up to 10 hours
- Can use up to 1/3 less wood than conventional wood stoves
- The baked enamel finish with decorative screen adds to the charm of any room
- Exclusive safety door closures so cabinet door will not close unless inner doors are properly secured – door knobs stay cooler
- Large removable ash pan for convenient ash removal
- Optional fan with thermostatic heat sensor ensures increased heat circulation throughout room. Air is distributed at floor level for maximum comfort.
- Lift top for cooking convenience
- 6" rear flue outlet
- Heavy duty cast iron grates



#### Specifications

CABINET	
High (")	33
Deep (")	20.5
Wide (")	32
FIREBOX	
Wide (")	11.5
High (")	19
Long (")	25.5
WEIGHT (LBS)	
	225

**NOTE:** Optional circulating fan available.

# NEWMAC COMBINATION FURNACES AND WOOD BURNING STOVES

## WOOD STOVES (cont'd)

### NS 220

#### For Home or Cottage Installation

The popular NS 220 offers a firebrick lining for long life, heat retention and improved combustion.

- Heats up to five average rooms (50,000 btu/h)
- Large capacity firebox takes 20" logs with a refueling cycle of up to 10 hours
- Can use up to 1/3 less wood than conventional wood stoves
- 6" top flue outlet
- Flue and Scandanavian Baffle provide increased efficiency and heat transfer
- Cabinet is black with high heat resistant painted coating
- Lift top for cooking convenience
- Louvered top directs warm air forward and to the sides
- Front loading with hearth logs up to 20"
- Heavy gauge steel and high temperature firebrick lined firebox



#### Specifications

CABINET	
High (")	30
Deep (")	29
Wide (")	19
FIREBOX	
Wide (")	15
High (")	22
Long (")	22
WEIGHT (LBS)	
	225
HEIGHT OF LINER (")	
	12