

# QUADRA-FIRE®

## BRICK REPLACEMENT INSTRUCTIONS

PART:  
832-1970

FOR WOOD APPLIANCE:  
5100 INSERT PRE ACT

### Included in Kit:

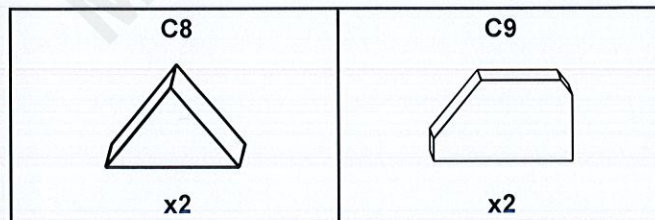
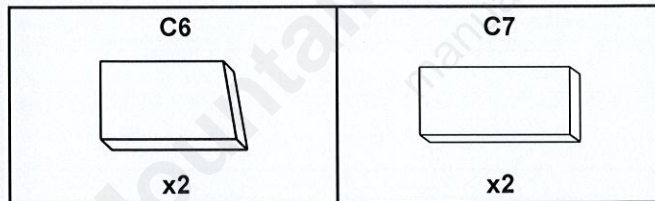
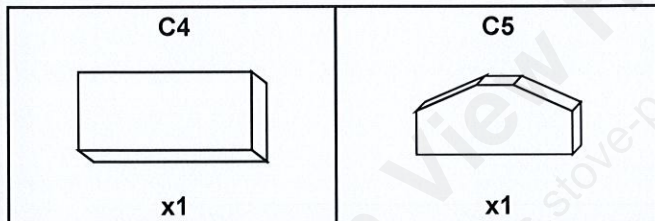
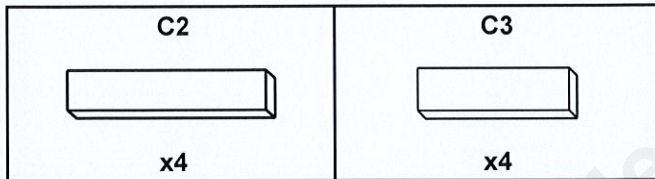
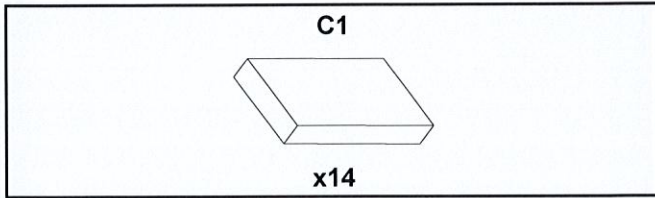

### Tools Needed:

Leather gloves, vacuum cleaner, and metal bucket and scoop made out of noncombustible material

### Included in kit:

Id	Description	Qty
C1	Brick, 9 x 4.5 x 1.25	14
C2	Brick, 9 x 1.75 x 1.25	4
C3	Brick, 8.5 x 2 x 1.25	4
C4	Brick, 8 x 4.5 x 1.25	1
C5	Brick, 8 x 4 x 1.25 with cut	1
C6	Brick, 7.5 x 3.5 x 1.25 with cut	2
C7	Brick, 7.5 x 4.5 x 1.25	2
C8	Brick, 4.875 x 2.759 x 1.25 with cut	2
C9	Brick, 8.5 x 4.5 x 1.25 with cut	2

### CAUTION



#### Injury Risk.

- Gloves recommended

### CAUTION

Ensure appliance is completely cooled before completing this service replacement.

### WARNING



#### Fire Risk.

#### Disposal of Ashes

- Ashes should be placed in metal container with tight fitting lid.
- Do not place metal container on combustible surface.
- Ashes should be retained in closed container until all cinders have thoroughly cooled.

1. After the coals have completely cooled. Remove all old brick and ash from appliance; vacuum firebox.
2. Remove new brick set from box and lay out to diagram shown in **Figure 1**.

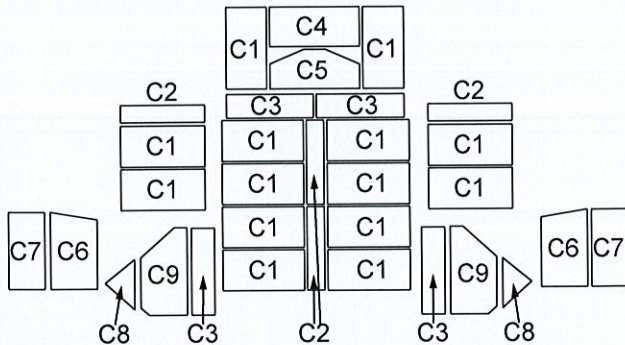

Figure 1

3. Lay bottom bricks in appliance (**Figure 2**).

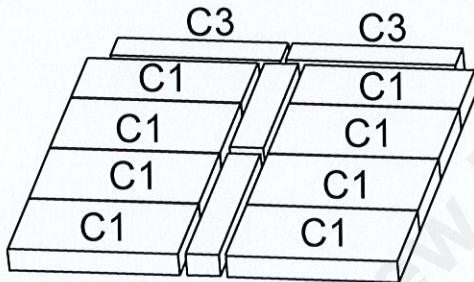

Figure 2

4. Install rear bricks at the back of the appliance. Slide the bricks under clip on back of firebox wall and push into place (**Figure 3**).

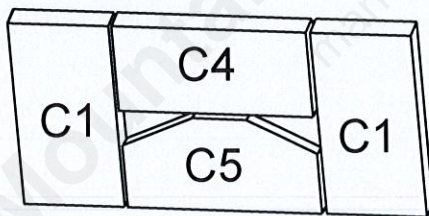

Figure 3

5. Install side bricks. Slide top of brick under clips on side of firebox and push the bottom of the brick until it is flush with the side of the appliance (**Figure 4**).

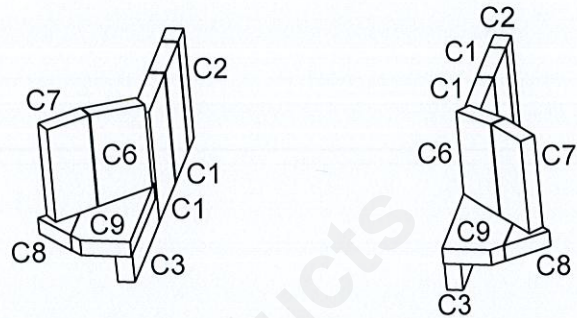

Figure 4

**CAUTION**

- Ensure that the firebricks are correctly positioned
- Firebox does not contain any broken bricks prior to operating the unit.

**NOTE:** The firebox is lined with high quality firebrick, which has exceptional insulating properties. **DO NOT** operate appliance without the firebrick.

**Associated Brick Service Part Numbers**

Part Number	Description
832-0550	Single Brick
832-3040	Brick uncut (pkg of 6)

6. Completed brick assembly inside of firebox should appear as shown in **Figure 5**.

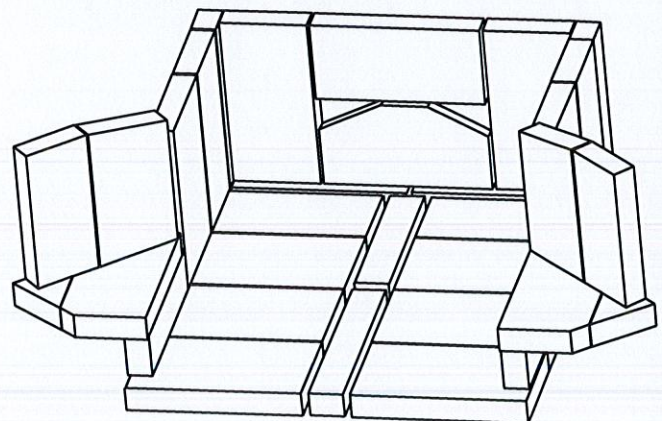

Figure 5