

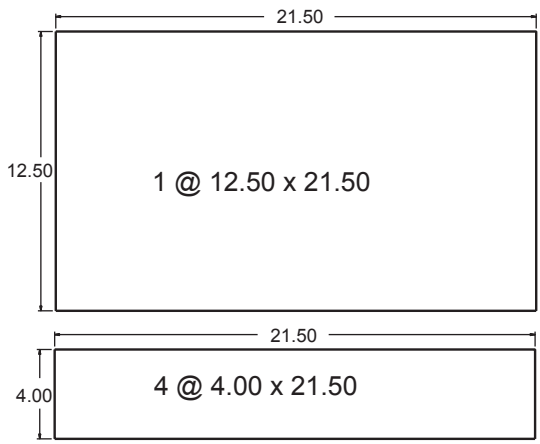

CERAMIC INSULATING BLANKET

 <p>1900 1/2 inch 832-3390</p>	 <p>21M-ACC 1/2 inch 832-3390</p>
 <p>21 / 21-I 1/2 inch 832-3390</p>	 <p>31M-ACC, 31ST-ACC, 31-I ACC 1/2 inch 832-3390</p>
 <p>43M-ACC, 43ST-ACC 1/2 inch 832-3390</p>	 <p>4300 (NON-ACT) 1/2 inch 832-3390</p>

CERAMIC INSULATING BLANKET

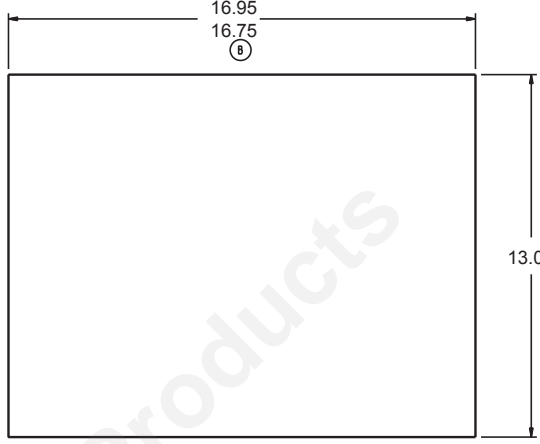
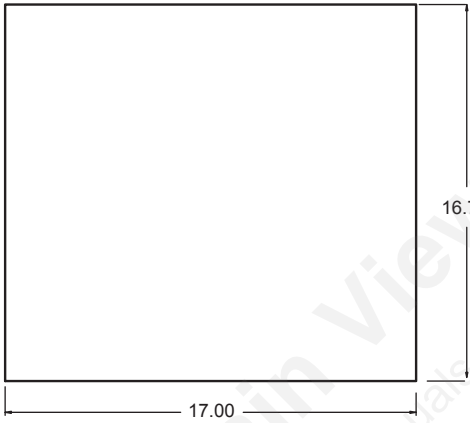
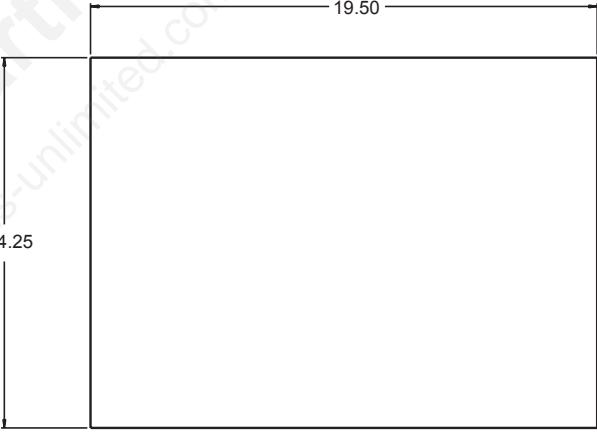
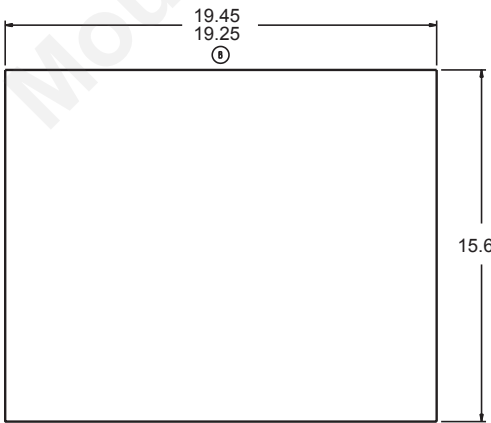

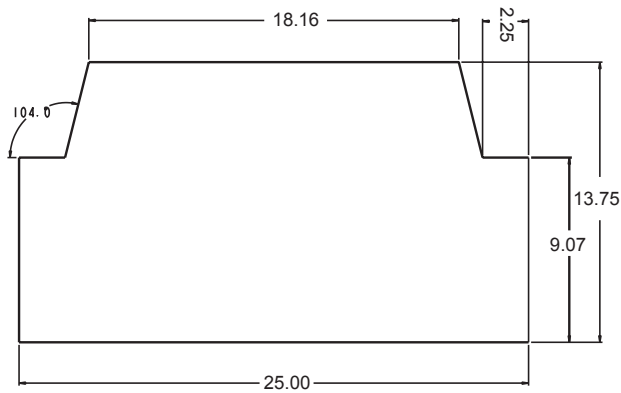
Cape Cod
1/2 inch **832-3390**

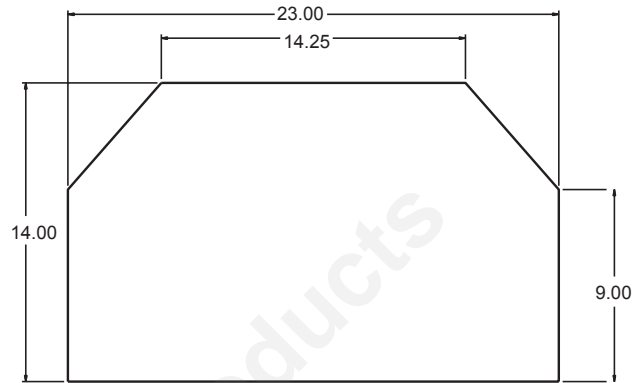

Cumberland Gap
1/2 inch **832-3390**

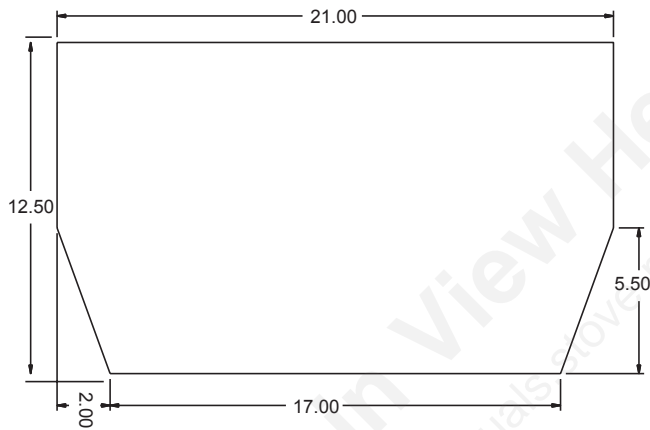

Yosemite
1/2 inch **832-3390**

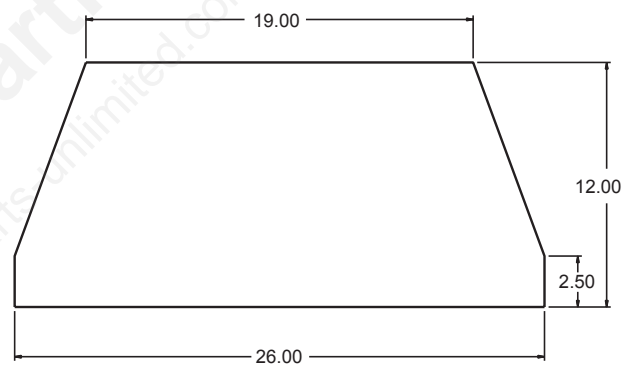

2700-Insert
1/2 inch **832-3390**

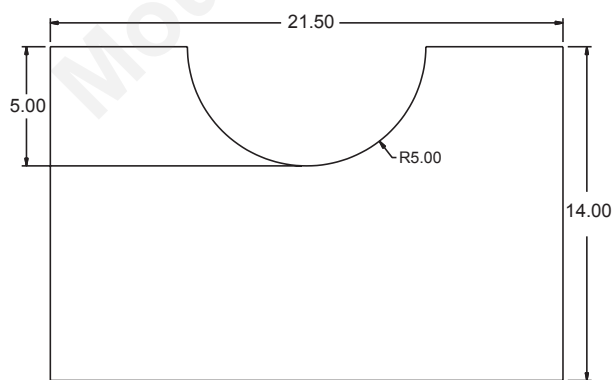

41-Insert & Bodega Bay
1/2 inch **832-3390**

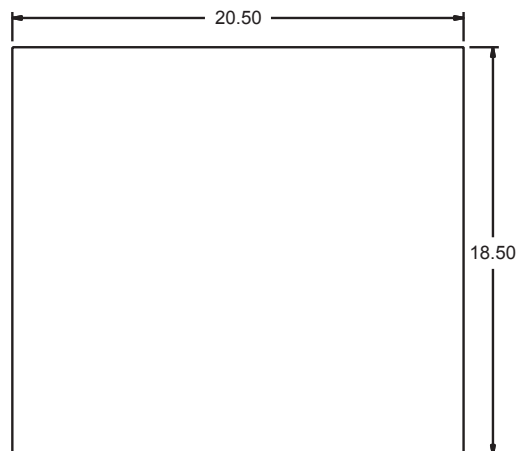

51-Insert
1/2 inch **832-3390**

CERAMIC INSULATING BLANKET

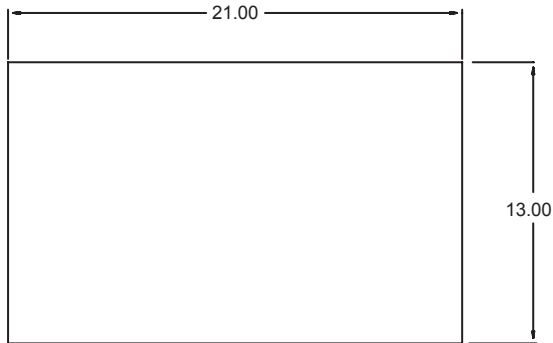

1800 / 1800-Insert
1 inch **832-3401**

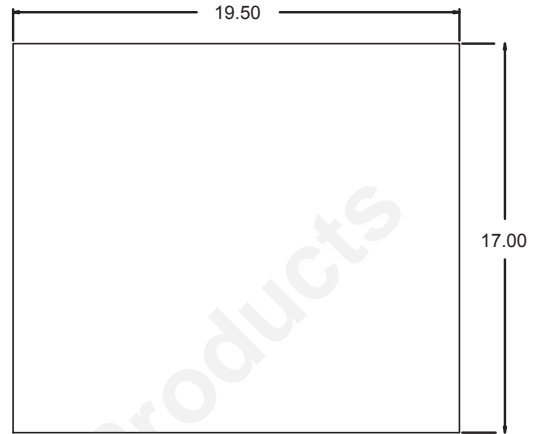

31 FS & 31-Insert **NON-ACT**
1 inch **832-3401**

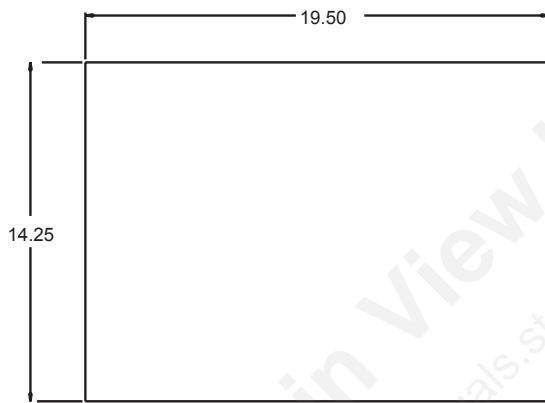

31-Insert ACT, 31-Uni-Body, 31M-ACT, 31ST-ACT
1 inch **832-3401**

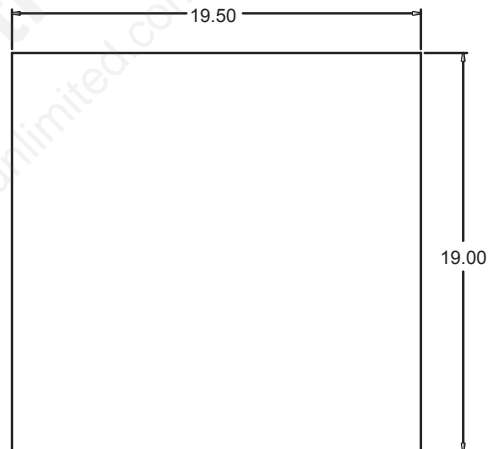

4100 FS
1 inch **832-3401**

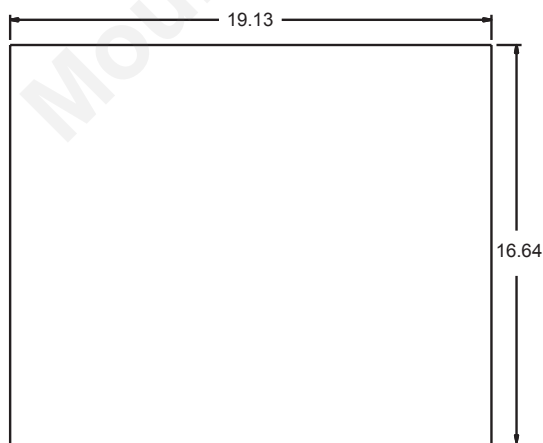

4300 ACT
1 inch **832-3401**

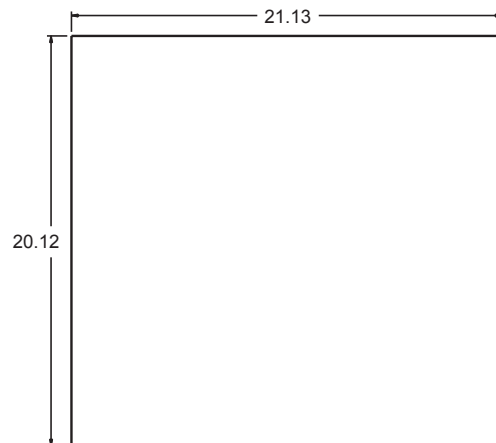

5700 ACT
1 inch **832-3401**

CERAMIC INSULATING BLANKET

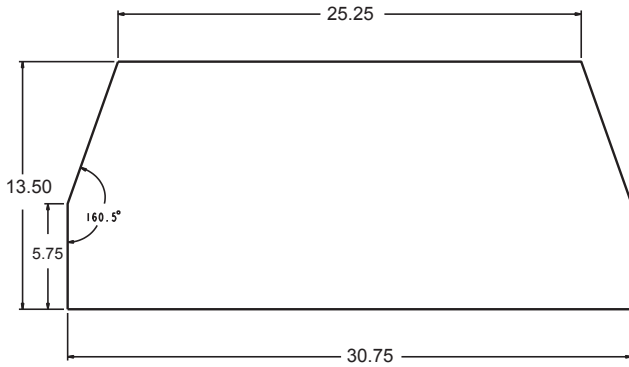

7100 FP, Fireplace
1 inch **832-3401**

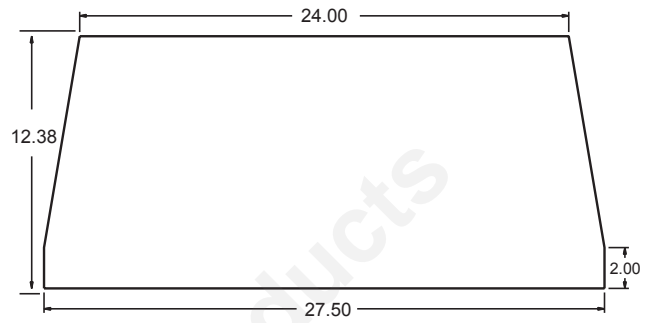

Constitution & Northstar Fireplace
1 inch **832-3401**

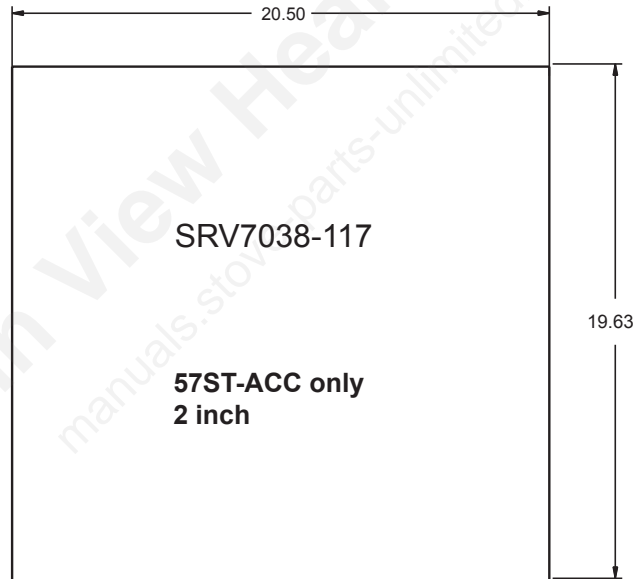

57ST-ACC
2 inch **SRV7038-117**