

QUADRA-FIRE®

BRICK REPLACEMENT INSTRUCTIONS PART: BRICK-7004 FOR WOOD APPLIANCE: YOSEMITE

Included in Kit:

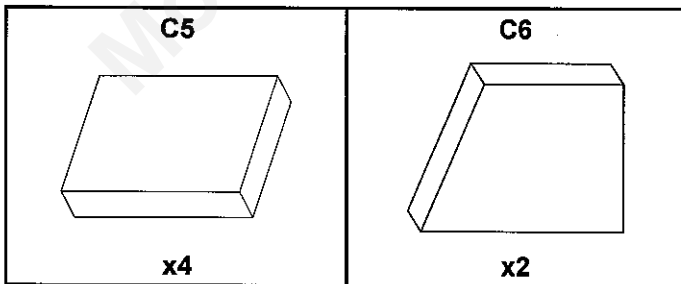
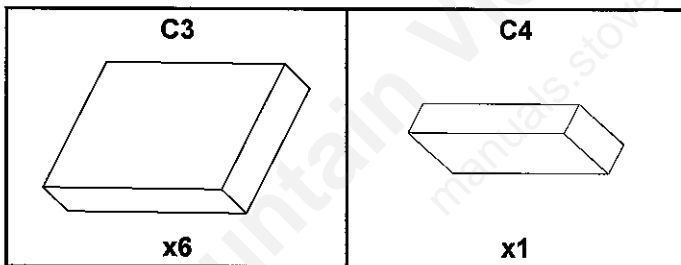
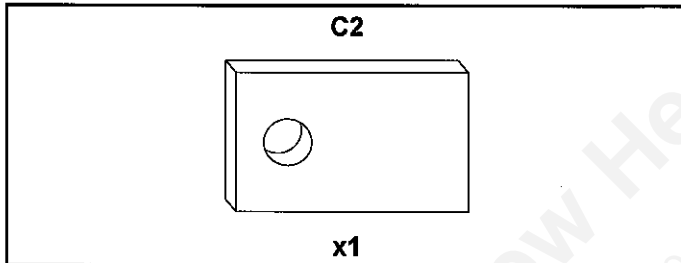
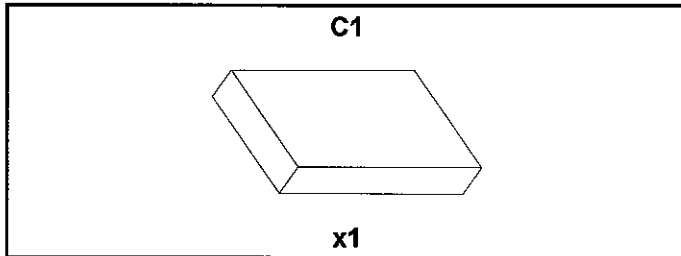

Tools Needed:

Leather gloves, vacuum cleaner, and metal bucket and scoop made out of noncombustible material

Included in kit:

Id	Description	Qty
C1	Brick, 9 x 4.5 x 1.25	1
C2	Brick, 7.25 x 4.5 x 1.25 with hole	1
C3	Brick, 7.5 x 4.5 x 1.25	6
C4	Brick, 7.5 x 2.5 x 1.25	1
C5	Brick, 5.4 x 4.5 x 1.25	4
C6	Brick, 5.25 x 4.5 x 1.25 with cut	2

**THIS BRICK PATTERN IS FOR
YOSEMITE APPLIANCES
SERIALIZED 1750843 & HIGHER.**



CAUTION



Injury Risk.

- Gloves recommended



CAUTION

Ensure appliance is completely cooled before completing this service replacement.



WARNING

Fire Risk.

Disposal of Ashes

- Ashes should be placed in metal container with tight fitting lid.
- Do not place metal container on combustible surface.
- Ashes should be retained in closed container until all cinders have thoroughly cooled.



1. After the coals have completely cooled. Remove all old brick and ash from appliance; vacuum firebox.
2. Remove new brick set from box and lay out to diagram shown in **Figure 1**.

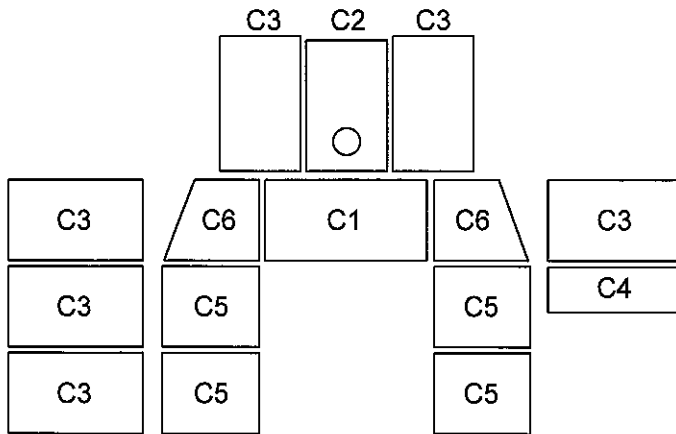

Figure 1

3. Install bottom bricks. Lay bottom bricks in appliance (**Figure 2**).

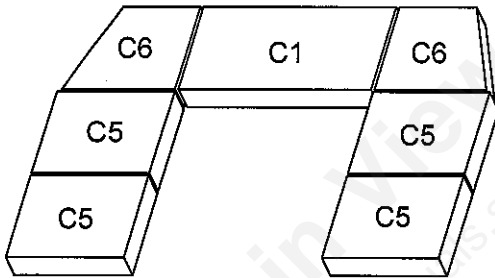

Figure 2

4. Install rear bricks at the back of the appliance. Slide the bricks under clip on back of firebox wall and push into place (**Figure 3**).

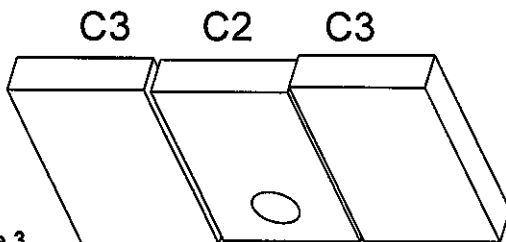

Figure 3

5. Install side bricks. Slide top of brick under clips on side of firebox and push the bottom of the brick until it is flush with the side of the appliance (**Figure 4**).

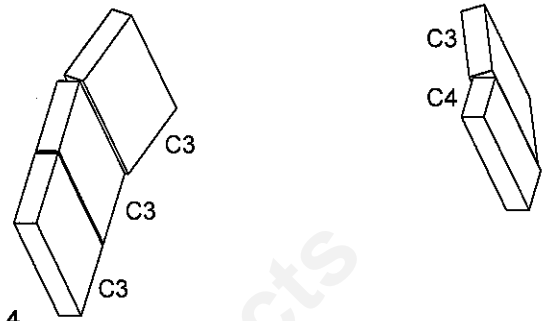

Figure 4



CAUTION

- Ensure that the firebricks are correctly positioned
- Firebox does not contain any broken bricks prior to operating the unit.

NOTE: The firebox is lined with high quality firebrick, which has exceptional insulating properties. **DO NOT** operate appliance without the firebrick.

Associated Brick Service Part Numbers

Part Number	Description
832-0550	Single Brick
832-3040	Brick uncut (pkg of 6)
SRV7004-199	Brick with hole (pkg of 1)

6. Completed brick assembly inside of firebox should appear as shown in **Figure 5**.

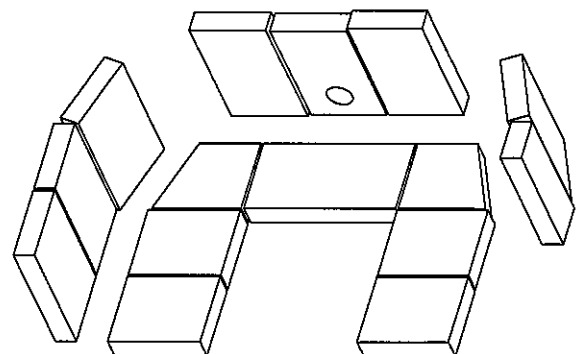

Figure 5