

Manufactured 1975 through 6/80, Defiant I has a one piece fireback; Defiant IA is a Defiant I converted to a two piece fireback, sides wrap around the front; Defiant IAI is a I or IA converted to a two piece fireback & two piece baffle, sides wrap around the front.

Defiant Schematics

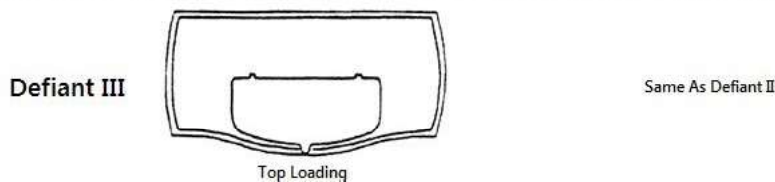
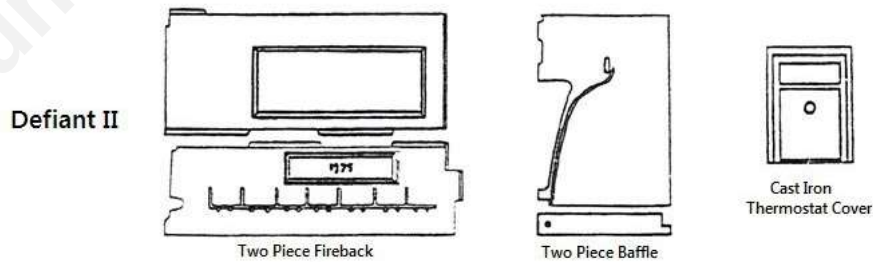
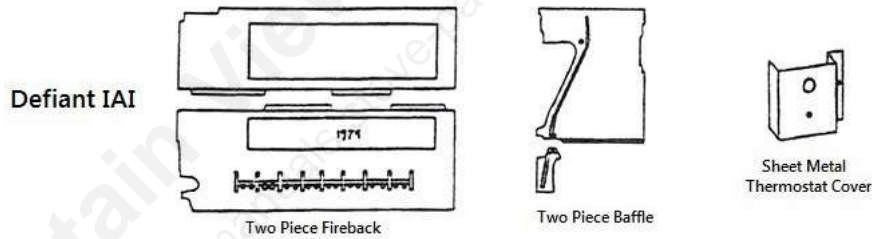
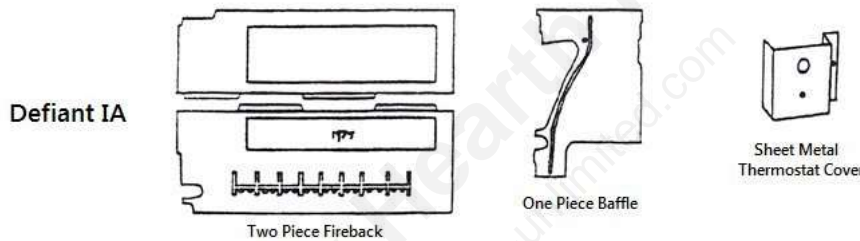
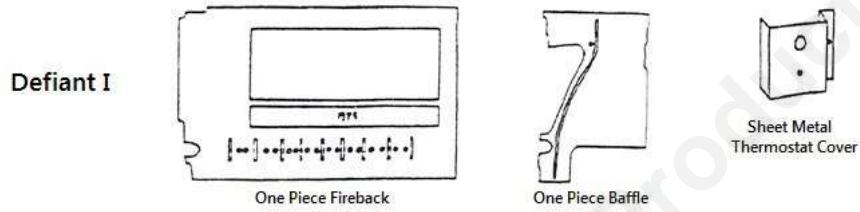

The Defiant II has an oval griddle with no top loading and has a wrap-around front.

Defiant Schematics

Defiant I

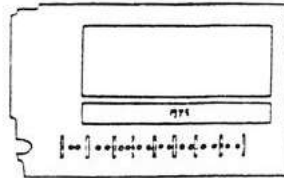

One Piece Fireback



One Piece Baffle



Sheet Metal
Thermostat Cover

Defiant IA

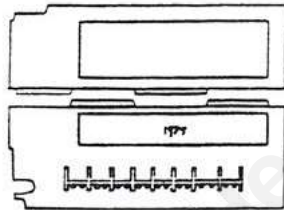

Two Piece Fireback



One Piece Baffle



Sheet Metal
Thermostat Cover

Defiant IAI

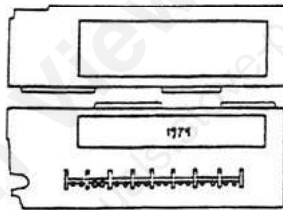

Two Piece Fireback



Two Piece Baffle



Sheet Metal
Thermostat Cover

Defiant II

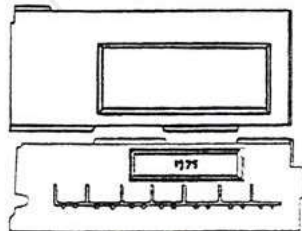

Two Piece Fireback

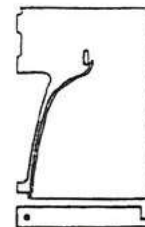

Two Piece Baffle

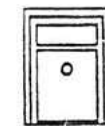

Cast Iron
Thermostat Cover

Defiant III

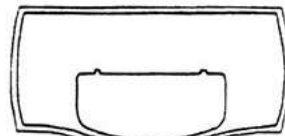

Top Loading

Same As Defiant II

DEFIANT III

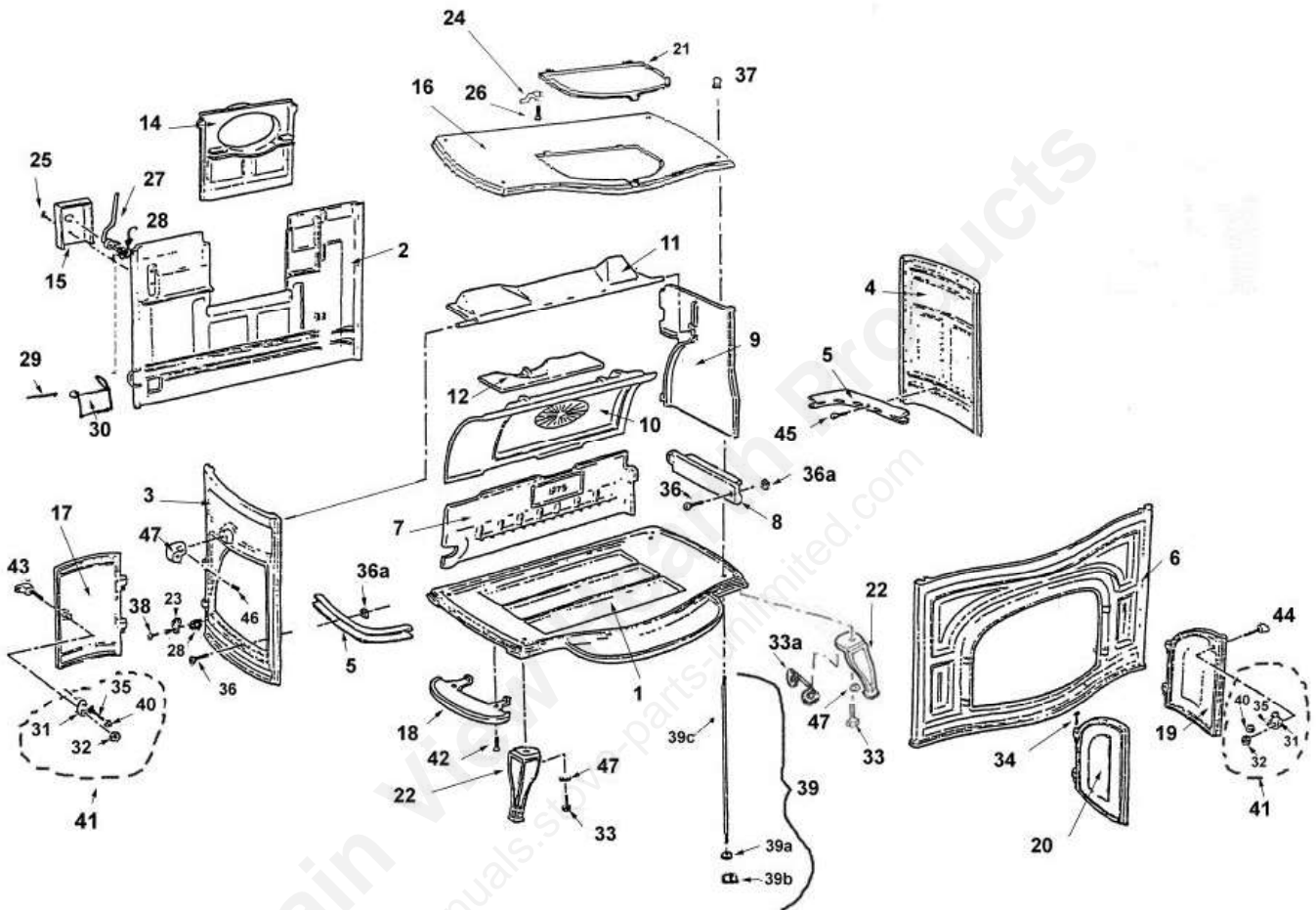

This stove has top loading griddle, wrap around front and a two-piece fireback.

Item	Description	Comments	Part #	Weight
1	Bottom	NLA	1303148	56.420
2	Back	NLA	1303070	51.750
3	Left End with Door		5000202	
4	Right End		1303116	
5	Air Tube		1303162	2.000
6	Front with Doors		5000285	
7	Lower Fireback		1303092	24.000
8	Lower Baffle		1303100	3.000
9	Upper Baffle		1303108	20.000
10	Upper Fireback		1303078	24.000
11	Damper W/Pin Assembly		5000323	10.300
12	Smoke Shelf		1303184	4.000
14	Rear Exit Insert		1303192	